

SIEMENS

SITRANS P

Pressure transmitter SITRANS LH100 Transmitter for Hydrostatic Level

Compact Operating Instructions

<u>Introduction</u>	1
<u>Safety instructions</u>	2
<u>Description</u>	3
<u>Installing/mounting</u>	4
<u>Connecting</u>	5
<u>Commissioning</u>	6
<u>Service and maintenance</u>	7
<u>Technical specifications</u>	8
<u>Dimension drawings</u>	9
<u>Appendix A</u>	A

7MF1572-.....

Legal information

Warning notice system

This manual contains notices you have to observe in order to ensure your personal safety, as well as to prevent damage to property. The notices referring to your personal safety are highlighted in the manual by a safety alert symbol, notices referring only to property damage have no safety alert symbol. These notices shown below are graded according to the degree of danger.

⚠ DANGER
indicates that death or severe personal injury will result if proper precautions are not taken.

⚠ WARNING
indicates that death or severe personal injury may result if proper precautions are not taken.

⚠ CAUTION
indicates that minor personal injury can result if proper precautions are not taken.

NOTICE
indicates that property damage can result if proper precautions are not taken.

If more than one degree of danger is present, the warning notice representing the highest degree of danger will be used. A notice warning of injury to persons with a safety alert symbol may also include a warning relating to property damage.

Qualified Personnel

The product/system described in this documentation may be operated only by **personnel qualified** for the specific task in accordance with the relevant documentation, in particular its warning notices and safety instructions. Qualified personnel are those who, based on their training and experience, are capable of identifying risks and avoiding potential hazards when working with these products/systems.

Proper use of Siemens products

Note the following:

⚠ WARNING
Siemens products may only be used for the applications described in the catalog and in the relevant technical documentation. If products and components from other manufacturers are used, these must be recommended or approved by Siemens. Proper transport, storage, installation, assembly, commissioning, operation and maintenance are required to ensure that the products operate safely and without any problems. The permissible ambient conditions must be complied with. The information in the relevant documentation must be observed.

Trademarks

All names identified by ® are registered trademarks of Siemens AG. The remaining trademarks in this publication may be trademarks whose use by third parties for their own purposes could violate the rights of the owner.

Disclaimer of Liability

We have reviewed the contents of this publication to ensure consistency with the hardware and software described. Since variance cannot be precluded entirely, we cannot guarantee full consistency. However, the information in this publication is reviewed regularly and any necessary corrections are included in subsequent editions.

Table of contents

1	Introduction	5
1.1	Purpose of this documentation.....	5
1.2	Checking the consignment.....	5
1.3	Transportation and storage.....	6
1.4	Notes on warranty.....	6
2	Safety instructions	7
2.1	Prerequisites for safe use.....	7
2.1.1	Laws and directives.....	7
2.1.2	Conformity with European directives.....	7
2.2	Improper device modifications.....	8
2.3	Requirements for special applications.....	8
2.4	Use in hazardous areas.....	8
3	Description	11
3.1	Application range.....	11
3.2	Structure.....	11
3.3	Design of the nameplate.....	11
3.4	Mode of operation.....	12
4	Installing/mounting	13
4.1	Basic safety instructions.....	13
4.1.1	Proper mounting.....	14
4.2	Installation.....	15
4.3	Setting up the measuring points.....	16
4.4	Establishing the measuring range.....	16
5	Connecting	17
5.1	Basic safety instructions.....	17
5.2	Connecting the device.....	19
6	Commissioning	21
6.1	Basic safety instructions.....	21
6.2	Calibrating.....	21
7	Service and maintenance	23
7.1	Basic safety instructions.....	23
7.2	Calibrating.....	23

7.3	Clean diaphragm	23
7.4	Maintenance and repair work	24
7.5	Return procedure	24
7.6	Disposal	25
8	Technical specifications.....	27
8.1	Certificates and approvals.....	30
9	Dimension drawings	31
A	Appendix A	33
A.1	Technical support.....	33
A.2	Certificates	34
	Index.....	35

Introduction

1.1 Purpose of this documentation

These instructions contain all information required to commission and use the device. Read the instructions carefully prior to installation and commissioning. In order to use the device correctly, first review its principle of operation.

The instructions are aimed at persons mechanically installing the device, connecting it electronically, configuring the parameters and commissioning it, as well as service and maintenance engineers.

See also

Technical support (Page 33)

1.2 Checking the consignment

1. Check the packaging and the delivered items for visible damages.
2. Report any claims for damages immediately to the shipping company.
3. Retain damaged parts for clarification.
4. Check the scope of delivery by comparing your order to the shipping documents for correctness and completeness.

 WARNING
Using a damaged or incomplete device
Risk of explosion in hazardous areas.
<ul style="list-style-type: none">• Do not use damaged or incomplete devices.

1.3 Transportation and storage

To guarantee sufficient protection during transport and storage, observe the following:

- Keep the original packaging for subsequent transportation.
- Devices/replacement parts should be returned in their original packaging.
- If the original packaging is no longer available, ensure that all shipments are properly packaged to provide sufficient protection during transport. Siemens cannot assume liability for any costs associated with transportation damages.

NOTICE
Insufficient protection during storage
The packaging only provides limited protection against moisture and infiltration.
<ul style="list-style-type: none">• Provide additional packaging as necessary.

Special conditions for storage and transportation of the device are listed in Technical specifications (Page 27).

1.4 Notes on warranty

The contents of this manual shall not become part of or modify any prior or existing agreement, commitment or legal relationship. The sales contract contains all obligations on the part of Siemens as well as the complete and solely applicable warranty conditions. Any statements regarding device versions described in the manual do not create new warranties or modify the existing warranty.

The content reflects the technical status at the time of publishing. Siemens reserves the right to make technical changes in the course of further development.

Safety instructions

2.1 Prerequisites for safe use

This device left the factory in good working condition. In order to maintain this status and to ensure safe operation of the device, observe these instructions and all the specifications relevant to safety.

Observe the information and symbols on the device. Do not remove any information or symbols from the device. Always keep the information and symbols in a completely legible state.

Symbol	Explanation
	Consult operating instructions

2.1.1 Laws and directives

Observe the safety rules, provisions and laws applicable in your country during connection, assembly and operation. These include, for example:

- National Electrical Code (NEC - NFPA 70) (USA)
- Canadian Electrical Code (CEC) (Canada)

Further provisions for hazardous area applications are for example:

- IEC 60079-14 (international)
- EN 60079-14 (EU)

2.1.2 Conformity with European directives

The CE mark on the device is a sign of conformity with the following European directives:

Electromagnetic compatibility EMC 2014/30/EU	Directive of the European Parliament and of the Council on the harmonisation of the laws of the Member States relating to electromagnetic compatibility.
Atmosphère explosible ATEX 2014/34/EU	Directive of the European Parliament and of the Council on the harmonisation of the laws of the Member States relating to equipment and protective systems intended for use in potentially explosive atmospheres.

The standards applied can be found in the EC declaration of conformity for the device.

2.2 Improper device modifications

 WARNING
Improper device modifications
Risk to personnel, system and environment can result from modifications to the device, particularly in hazardous areas.
<ul style="list-style-type: none">• Only carry out modifications that are described in the instructions for the device. Failure to observe this requirement cancels the manufacturer's warranty and the product approvals.

2.3 Requirements for special applications

Due to the large number of possible applications, each detail of the described device versions for each possible scenario during commissioning, operation, maintenance or operation in systems cannot be considered in the instructions. If you need additional information not covered by these instructions, contact your local Siemens office or company representative.

Note

Operation under special ambient conditions

We highly recommend that you contact your Siemens representative or our application department before you operate the device under special ambient conditions as can be encountered in nuclear power plants or when the device is used for research and development purposes.

2.4 Use in hazardous areas

Qualified personnel for hazardous area applications

Persons who install, connect, commission, operate, and service the device in a hazardous area must have the following specific qualifications:

- They are authorized, trained or instructed in operating and maintaining devices and systems according to the safety regulations for electrical circuits, high pressures, aggressive, and hazardous media.
- They are authorized, trained, or instructed in carrying out work on electrical circuits for hazardous systems.
- They are trained or instructed in maintenance and use of appropriate safety equipment according to the pertinent safety regulations.

 WARNING
Use in hazardous area
Risk of explosion.
<ul style="list-style-type: none">• Only use equipment that is approved for use in the intended hazardous area and labelled accordingly.• Don't use devices that have been operated outside the conditions specified for hazardous areas. If you have used the device outside the conditions for hazardous areas permanently make all Ex markings unrecognizable on the nameplate.

See also

Technical specifications (Page 27)

 WARNING
Loss of safety of device with type of protection "Intrinsic safety Ex i"
If the device has already been operated in non-intrinsically safe circuits or the electrical specifications have not been observed, the safety of the device is no longer ensured for use in hazardous areas. There is a risk of explosion.
<ul style="list-style-type: none">• Connect the device with type of protection "Intrinsic safety" solely to an intrinsically safe circuit.• Observe the specifications for the electrical data on the certificate and/or in Technical specifications (Page 27).

Description

3.1 Application range

The pressure transmitter LH100 is a submersible sensor for hydrostatic level measurement. The pressure transmitter measures the liquid levels in tanks, containers, channels and dams.

The pressure transmitter is available for various measuring ranges and optionally with explosion protection. A cable box and an anchor clamp are available as accessories to make installation easier.

The pressure transmitter is used, for example, in the following industrial areas:

- Water supply
- For use in pressureless/open tanks and wells

3.2 Structure

The pressure transmitter has a built-in ceramic sensor which is equipped with a Wheatstone resistance bridge.

The pressure transmitter is equipped with electronics that is installed, together with the sensor, in a stainless steel enclosure. There is also a vent pipe in the connecting cable.

The measuring diaphragm is effectively protected against external influences by a protective cover.

The sensor, the electronics and the connecting cable are housed in an enclosure with small dimensions.

The pressure transmitter is compensated for a wide temperature range.

3.3 Design of the nameplate

The pressure transmitter has a nameplate with the article number and other important information, such as design details and technical specifications.

You must also observe the information in the relevant certificate for a transmitter version for use in hazardous areas.

3.4 Mode of operation

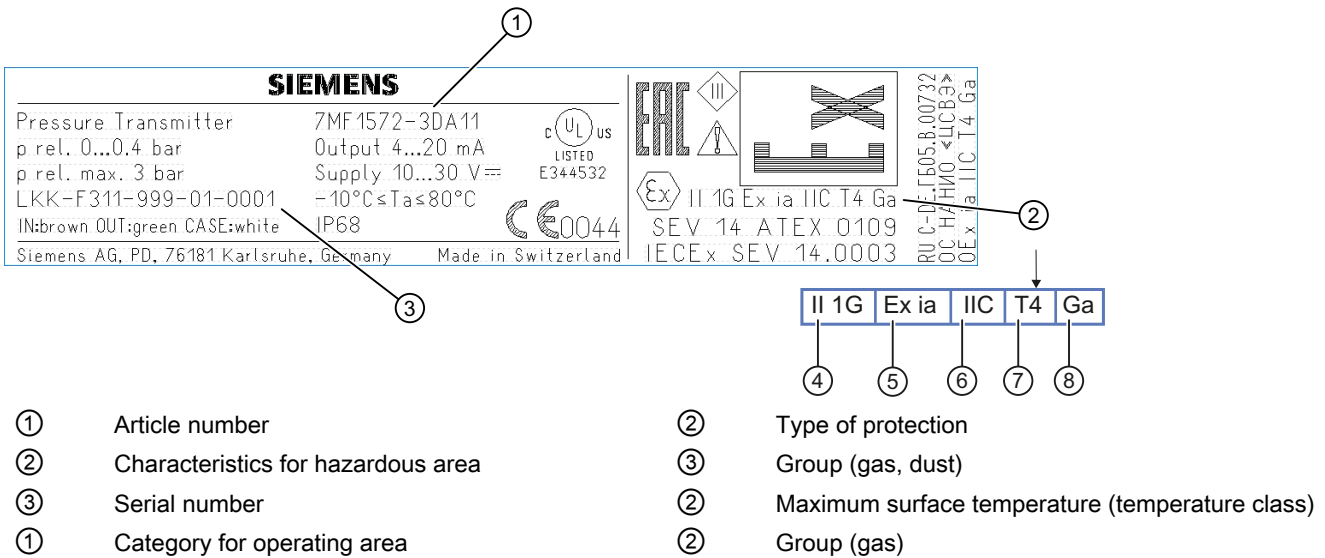

Figure 3-1 Example of a nameplate

3.4 Mode of operation

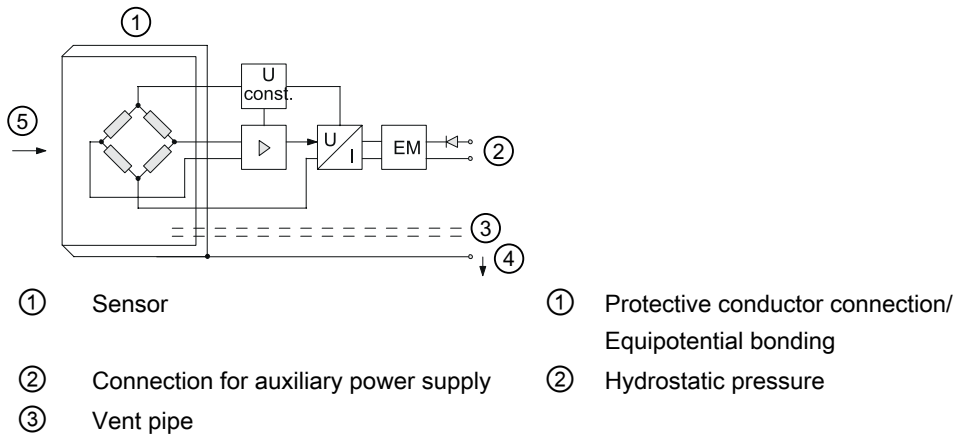

Figure 3-2 Pressure transmitter, mode of operation and wiring diagram

On one side of the sensor ① the diaphragm is exposed to the hydrostatic pressure ⑤, which is proportional to the immersion depth. This pressure is compared with the atmospheric pressure. Pressure compensation is carried out using the vent pipe ③ in the connecting cable.

The hydrostatic pressure of the liquid column acts on the diaphragm of the sensor and transmits the pressure to the Wheatstone resistance bridge in the sensor.

The output voltage signal of the sensor is fed to the electronics, where it is converted into an output current signal of 4 mA to 20 mA.

The protective conductor connection/equipotential bonding ④ is connected to the enclosure.

Installing/mounting

4.1 Basic safety instructions

 WARNING**Wetted parts unsuitable for the process media**

Risk of injury or damage to device.

Hot, toxic and corrosive media could be released if the process medium is unsuitable for the wetted parts.

- Ensure that the material of the device parts wetted by the process medium is suitable for the medium. Refer to the information in Technical specifications (Page 27).

Note**Material compatibility**

Siemens can provide you with support concerning selection of sensor components wetted by process media. However, you are responsible for the selection of components. Siemens accepts no liability for faults or failures resulting from incompatible materials.

 WARNING**Exceeded maximum ambient or process media temperature**

Danger of explosion in hazardous areas.

Device damage.

- Make sure that the maximum permissible ambient and process media temperatures of the device are not exceeded. Refer to the information in Technical specifications (Page 27).

NOTICE**Using a device with frozen process medium**

Damage to the device through ice formation.

- Prevent ice formation on the pressure transmitter. The process medium must not freeze.

4.1.1 Proper mounting

NOTICE
Incorrect mounting The device can be damaged, destroyed, or its functionality impaired through improper mounting. <ul style="list-style-type: none">• Before installing ensure there is no visible damage to the device.• Make sure that process connectors are clean, and suitable gaskets and glands are used.• Mount the device using suitable tools. Refer to the information in Technical specifications (Page 27).

 CAUTION
Loss of type of protection Damage to device if the enclosure is open or not properly closed. The type of protection specified on the nameplate or in Technical specifications (Page 27) is no longer guaranteed. <ul style="list-style-type: none">• Make sure that the device is securely closed.

4.2 Installation

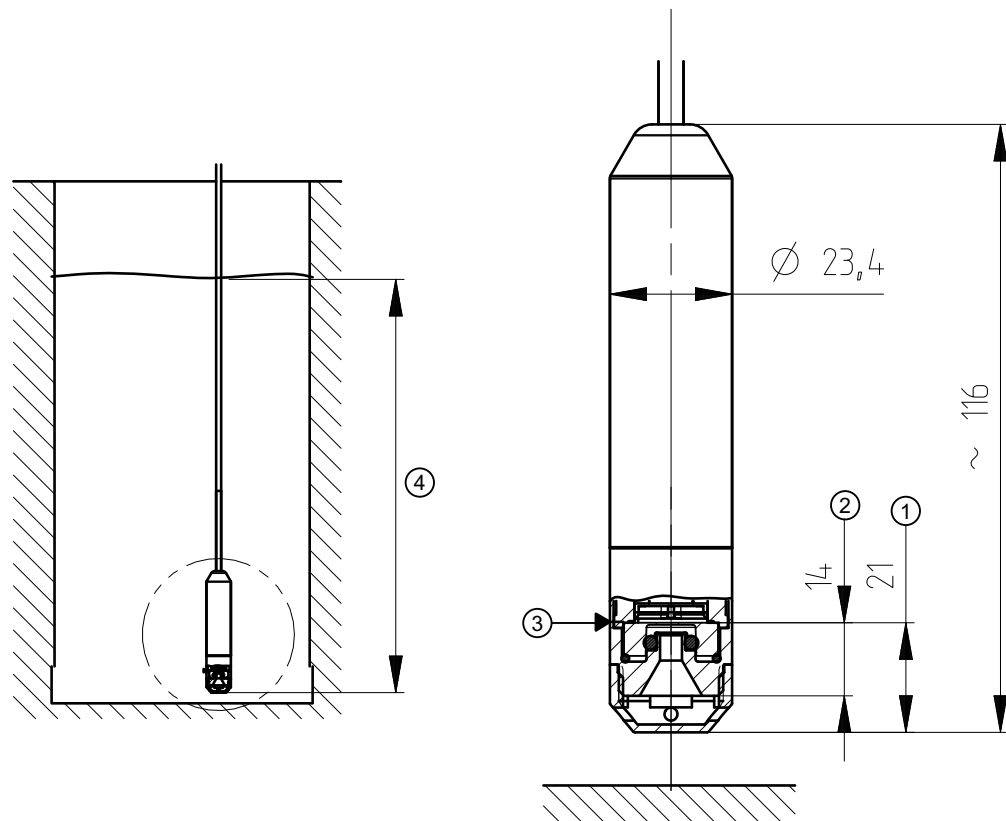



- | | | | |
|---|---|---|------------------------------|
| ① | Distance from the start of the protective cover to the height of the measuring diaphragm | ③ | Measurement reference height |
| ② | Distance from the start of the thread pick-up to the height of the measuring diaphragm (version without protective cover) | ④ | Level |

Figure 4-1 Mounting the pressure transmitter, dimensions in mm

1. Install the pressure transmitter suspended downward on the cable.
2. To prevent measuring errors, fasten the pressure transmitter for moved process media.
3. Fasten the pressure transmitter by means of a guide tube or an additional weight on the transmitter (max. tensile force on connecting cable 250 N).
4. Fasten the cable above the container with the anchor clamp.
5. Connect the cable itself with the cable box.
6. Mount the cable box at a location appropriate to its degree of protection (IP66) in the vicinity of the measuring point.
7. To ensure proper functioning, make sure that the entry openings on the protective cover of the pressure transmitter do not get soiled and that the process medium does not freeze.

5.1 Basic safety instructions

 WARNING
Unsuitable cables, cable glands and/or plugs
Risk of explosion in hazardous areas.
<ul style="list-style-type: none">• Use only cable glands/plugs that comply with the requirements for the relevant type of protection.• Tighten the cable glands in accordance with the torques specified in Technical specifications (Page 27).• Close unused cable inlets for the electrical connections.• When replacing cable, glands use only cable glands of the same type.• After installation, check that the cables are seated firmly.

 WARNING
Improper power supply
Risk of explosion in hazardous areas and loss of device safety as a result of incorrect power supply, e.g. using direct current instead of alternating current.
<ul style="list-style-type: none">• Connect the device in accordance with the specified power supply and signal circuits. The relevant specifications can be found in the certificates, in Chapter "Technical specifications (Page 27)" or on the nameplate.• Always power the device with limited energy. Observe the following standards on limited energy: UL61010-1 3rd Edition, Section 9.3 or LPS (Low Power Supply) in accordance with UL60950-1 or Class 2 in accordance with UL1310 or UL1585.

 WARNING
Lack of equipotential bonding
Risk of explosion through compensating currents or ignition currents through lack of equipotential bonding.
<ul style="list-style-type: none">• Ensure that the device is potentially equalized.
Exception: It may be permissible to omit connection of the equipotential bonding for devices with type of protection "Intrinsic safety Ex i".

 WARNING
Unprotected cable ends Risk of explosion through unprotected cable ends in hazardous areas. <ul style="list-style-type: none">• Protect unused cable ends in accordance with IEC/EN 60079-14.

 WARNING
Improper laying of shielded cables Risk of explosion through compensating currents between hazardous area and the non-hazardous area. <ul style="list-style-type: none">• Shielded cables that cross into hazardous areas should be grounded only at one end.• If grounding is required at both ends, use an equipotential bonding conductor.

 WARNING
Connecting device in energized state Risk of explosion in hazardous areas. <ul style="list-style-type: none">• Connect devices in hazardous areas only in a de-energized state. Exceptions: <ul style="list-style-type: none">• Devices having the type of protection "Intrinsic safety Ex i" may also be connected in energized state in hazardous areas.• Exceptions for type of protection "Increased safety ec" (Zone 2) are regulated in the relevant certificate.

Note
Electromagnetic compatibility (EMC)
You can use this device in industrial environments, households and small businesses.
For metal housings there is an increased electromagnetic compatibility compared to high-frequency radiation. This protection can be increased by grounding the housing, see Connecting (Page 17).

Note
Improvement of interference immunity

- Lay signal cables separately to cables with voltages > 60 V.
- Use cable with twisted wires.
- Keep the device and the cables at a distance from strong electromagnetic fields.

5.2 Connecting the device

Procedure

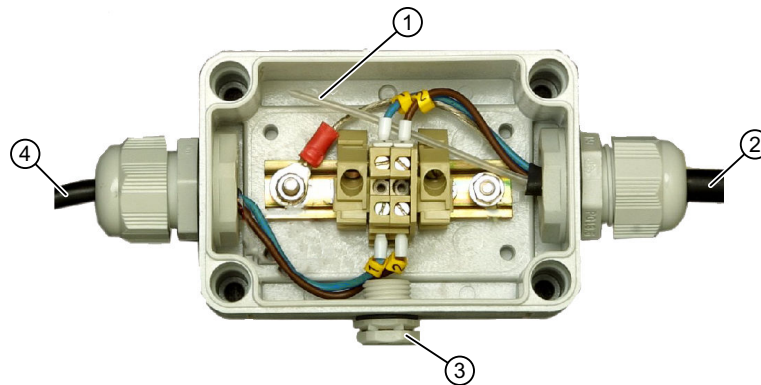

- | | | | |
|---|---------------------------------------|---|---|
| ① | Ventilation pipe or ventilation pipes | ③ | Humidity filter |
| ② | Connection to transmitter | ④ | Connection to measured value processing |

Figure 5-1 Cable box (example for applications in hazardous area)

1. Connect the cable of the pressure transmitter to the terminals as follows:
 - Green (-)
 - Brown (+)
 - White (protective conductor connection/potential equalization)
2. Insert the ventilation pipe ① into the cable box.
The ventilation pipe must be connected to the atmosphere. The humidity filter is used for this purpose ③.

Wiring diagram

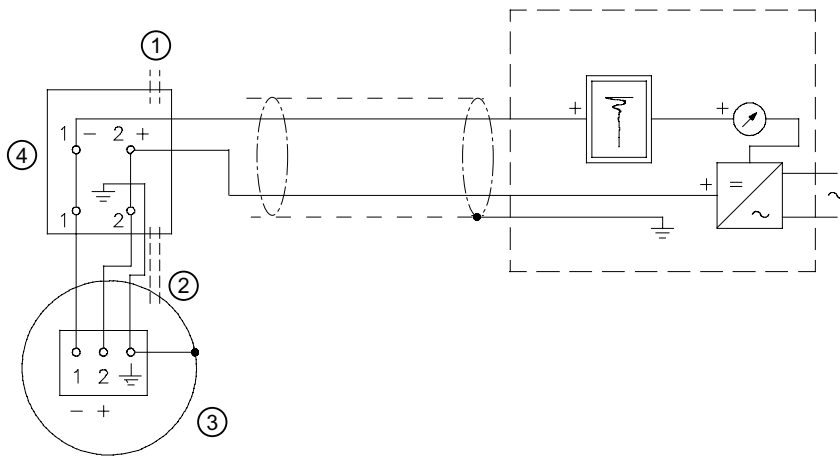

- ① Atmospheric pressure
- ② Vent pipe
- ③ Transmitter
- ④ Cable box

Figure 5-2 Example for applications in hazardous area

Commissioning

6.1 Basic safety instructions

 WARNING
Improper commissioning in hazardous areas Device failure or risk of explosion in hazardous areas. <ul style="list-style-type: none">• Do not commission the device until it has been mounted completely and connected in accordance with the information in Technical specifications (Page 27).• Before commissioning take the effect on other devices in the system into account.

6.2 Calibrating

The pressure transmitter was calibrated to the measuring range at the manufacturer and cannot be re-calibrated.

Service and maintenance

7.1 Basic safety instructions

Note

The device is maintenance-free.

 WARNING**Impermissible repair of explosion protected devices**

Risk of explosion in hazardous areas

- Repair must be carried out by Siemens authorized personnel only.

 WARNING**Use of a computer in a hazardous area**

If the interface to the computer is used in the hazardous area, there is a risk of explosion.

- Ensure that the atmosphere is explosion-free (hot work permit).

7.2 Calibrating

The pressure transmitter was calibrated to the measuring range at the manufacturer and cannot be re-calibrated.

7.3 Clean diaphragm

If the mediums are contaminated, viscous or crystallized, it could be necessary to clean the diaphragm from time to time. Only remove deposits on the diaphragm using a suitable solvent. Do not use corrosive cleaning agents.

NOTICE**Improper cleaning of diaphragm**

Device damage. The diaphragm can be damaged.

- Do not use sharp or hard objects to clean the diaphragm.

7.4 Maintenance and repair work

⚠ WARNING
Impermissible accessories and spare parts
Risk of explosion in areas subject to explosion hazard.
<ul style="list-style-type: none">• Only use original accessories or original spare parts.• Observe all relevant installation and safety instructions described in the instructions for the device or enclosed with the accessory or spare part.

NOTICE
Faulty measurement caused by dirt
The pressure transmitter can become soiled by the process medium.
<ul style="list-style-type: none">• Prevent any dirt accumulating on the entry openings on the protective cover of the pressure transmitter.

7.5 Return procedure

Enclose the bill of lading, return document and decontamination certificate in a clear plastic pouch and attach it firmly to the outside of the packaging.

Required forms

- Delivery note
- Return document (<http://www.siemens.com/processinstrumentation/returngoodsnote>) with the following information:
 - Product (item description)
 - Number of returned devices/replacement parts
 - Reason for returning the item(s)
- Decontamination declaration (<http://www.siemens.com/sc/declarationofdecontamination>)
With this declaration you warrant "that the device/replacement part has been carefully cleaned and is free of residues. The device/replacement part does not pose a hazard for humans and the environment."
If the returned device/replacement part has come into contact with poisonous, corrosive, flammable or water-contaminating substances, you must thoroughly clean and decontaminate the device/replacement part before returning it in order to ensure that all hollow areas are free from hazardous substances. Check the item after it has been cleaned. Any devices/replacement parts returned without a decontamination declaration will be cleaned at your expense before further processing.

7.6 Disposal

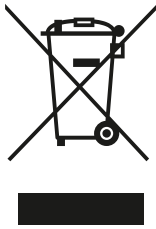

Devices described in this manual should be recycled. They may not be disposed of in the municipal waste disposal services according to the Directive 2012/19/EC on waste electronic and electrical equipment (WEEE).

Devices can be returned to the supplier within the EC, or to a locally approved disposal service for eco-friendly recycling. Observe the specific regulations valid in your country.

Further information about devices containing batteries can be found at: Technical specifications (Page 27)

Note

Special disposal required

The device includes components that require special disposal.

- Dispose of the device properly and environmentally through a local waste disposal contractor.
-

Technical specifications

Gauge pressure input		
Measured variable	Hydrostatic level	
Measuring range, max. operating pressure (according to 97/23/EC Pressure Equipment Directive) and max. test pressure (according to DIN 16086)	Measuring range	Maximum operating pressure MAWP (PS)
	0... 0.3 bar	1.5 bar
	0...3 mH ₂ O (0...9 ftH ₂ O)	21.8 psi 15 mH ₂ O (45 ftH ₂ O)
	0... 0.4 bar	1.5 bar
	0...4 mH ₂ O (0...12 ftH ₂ O)	21.8 psi 15 mH ₂ O (45 ftH ₂ O)
	0... 0.5 bar	1.5 bar
	0...5 mH ₂ O (0...15 ftH ₂ O)	21.8 psi 15 mH ₂ O (45 ftH ₂ O)
	0... 0.6 bar	1.5 bar
	0...6 mH ₂ O (0...18 ftH ₂ O)	21.8 psi 15 mH ₂ O (45 ftH ₂ O)
	0... 1 bar	3.0 bar
	0...10 mH ₂ O (0...30 ftH ₂ O)	43.5 psi 30 mH ₂ O (90 ftH ₂ O)
	0... 2 bar	5.0 bar
	0...20 mH ₂ O (0...60 ftH ₂ O)	72.5 psi3 50 mH ₂ O (150 ftH ₂ O)
2-wire output		
Output signal	4 ... 20 mA	
Load	Resistor R [Ω]	
	$R_{\max} = \frac{U_H - 10 \text{ V}}{0,02 \text{ A}}$	
U _H	Auxiliary power supply in V	
Measuring accuracy (according to EN 60770-2)		
Reference conditions	<ul style="list-style-type: none"> • Rising characteristic curve • Start-of-scale 0 bar • Room temperature 25 °C (77 °F) 	
Measurement deviation with limit setting, including hysteresis and for repeatability for measuring range	0.3% of full-scale value (typical)	

Measuring accuracy (according to EN 60770-2)

- 0 ...3 mH₂O (0...9 ftH₂O or 0...0.3 bar) 0.5% of full-scale value (typical)
- for all other measuring ranges 0.3% of full-scale value (typical)

Effect of ambient temperature

Zero point and measuring range

- 3 mH₂O (9 ftH₂O and 0.3 bar) 0.5% / 10K of full-scale value
- 4 ... 6 mH₂O (12 ... 18 ftH₂O) or 0.4...0.6 bar) 0.45% /10 K of full-scale value
- ≥ 6 mH₂O (≥ 18 ftH₂O or ≥ 0.6 bar) 0.3% / 10 K of full-scale value

Long-term stability

Zero point and measuring range

- 3 mH₂O (9 ftH₂O and 0.3 bar) 0.4% / 10K of full-scale value per year
- 4 ... 6 mH₂O (12 ... 18 ftH₂O) or 0.4...0.6 bar) 0.25% of full-scale value/year
- ≥ 6 mH₂O (≥ 18 ftH₂O or ≥ 0.6 bar) 0.2% of full-scale value/year

Effect of auxiliary power supply In percent per change in voltage
0.01% per 1 V

Rated conditions

Installation conditions

Ambient conditions

- Ambient temperature -10 ... +80 °C (-4 ... +176 °F)
 - Altitude Max. 2 000 m mean sea level
 - Relative humidity Use a suitable power supply at an altitude of more than 2 000 m above sea level.
0 ... 100%

Note Observe the temperature class in hazardous areas.

Storage temperature -40 ... +80 °C (-40 ... +176 °F)

- Degree of protection according to EN 60529 IP68

- Electromagnetic compatibility

Interference emission and interference immunity To EN 61326-1 and EN 61326-2-3

Process medium conditions

- Process medium temperature -10 ... +80 °C (-4 ... +176 °F)

Pressure transmitter construction

Weight

- Pressure transmitter Approx. 0.2 kg (0.44 lb)
- Cable 0.025 kg/m (approx. 0.015 lb/ft)

Material

- Wetted parts materials

Housing	Stainless steel, mat. no. 1.4404 or AISI 316L
Sensor	Ceramic Al ₂ O ₃ (96%)
Cable	PE-HD
Protective cover	PPE
Sealing material	FPM, EPDM (for drinking water)
Electric connection	Cable PE-HD: Lengths 2, 5, 10, 15, 20, 30 m
Torque for cable gland nut made of	Plastic 2.5 Nm (1.8 ft lb)

Cable box 7MF1572-8AA construction (accessory)

Field of application	For connecting the transmitter cable
Weight	0.2 kg (0.44 lb)
Electric connection	2 x 3-way (28 to 18 AWG)
Cable entry	2 x Pg 9
Enclosure material	Polycarbonate
Vent pipe for atmospheric pressure	
Screw for bearer wire	
Rated conditions	
• Degree of protection according to EN 60 529	IP66

Anchor clamp 7MF1572-8AB construction (accessory)

Field of application	For fastening the transmitter
Weight	0.16 kg (0.35 lb)
Electric connection	Galvanized steel, polyamide

Auxiliary power U_H

Terminal voltage at transmitter	 10 V DC ... 30 V DC <u> </u> 10 V DC to 33 V DC <u> </u>
Current consumption	< 20 mA
Reverse polarity protection	Yes

8.1 Certificates and approvals

Certificates and approvals	
Drinking water (ACS)	15 ACC NY 360
Drinking water (WRAS)	1403525
EAC	№ TC RU C-DE.ГБ05.В.007320С НАННО «ЦСВЭ»
Underwriters Laboratories (UL)	2014-11-17 - E344532
Explosion protection	
• Intrinsic safety "i"	IECEX SEV 14.0003 SEV 14 ATEX 0109
Marking	 II 1 G Ex ia IIC T4 Ga

Dimension drawings

Pressure transmitter

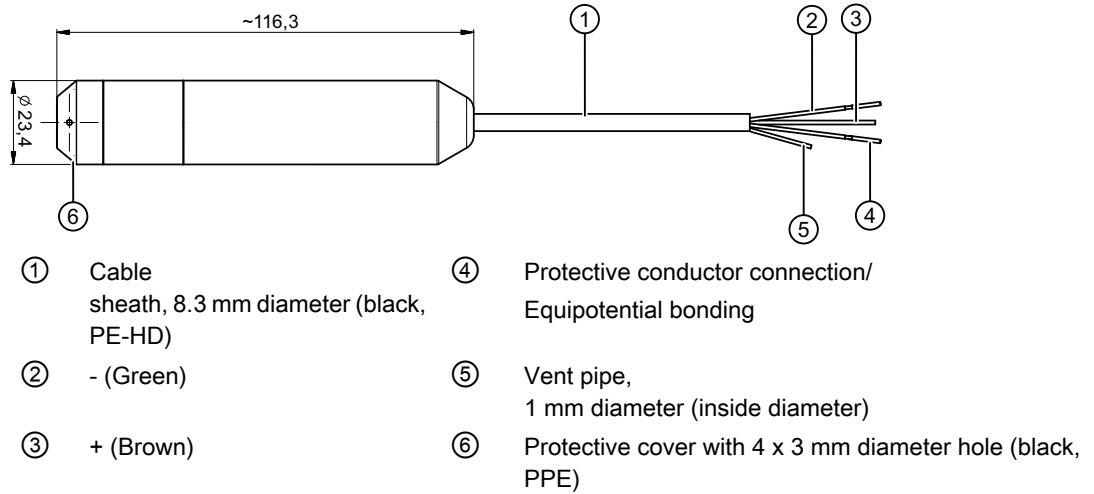

Figure 9-1 Pressure transmitter, dimensions in mm

Cable box

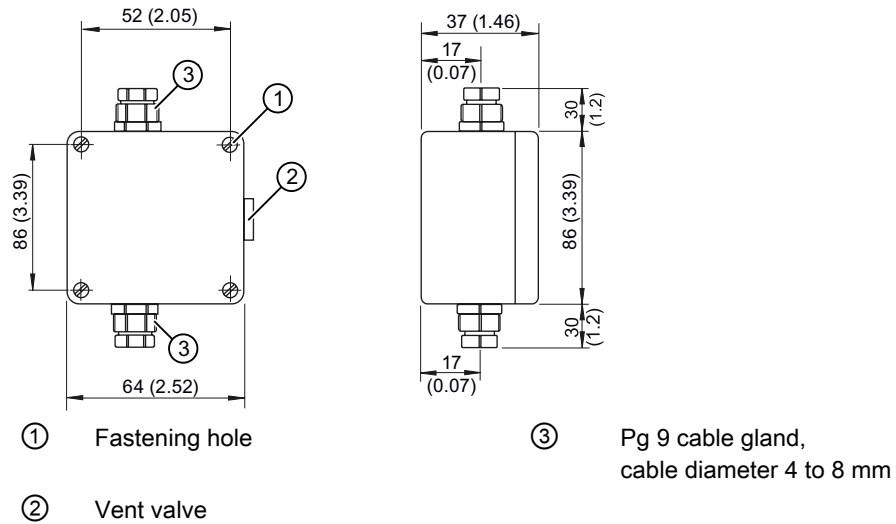
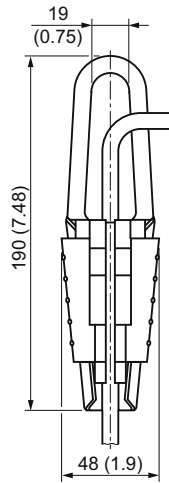

Figure 9-2 Cable box, dimensions in mm (inches)

Anchor clamp



Anchor clamp, dimensions in mm (inches)



Appendix A

A.1 Technical support

Technical Support

If this documentation does not provide complete answers to any technical questions you may have, contact Technical Support at:

- Support request (<http://www.siemens.com/automation/support-request>)
- More information about our Technical Support is available at Technical support (<http://www.siemens.com/automation/csi/service>)

Internet Service & Support

In addition to our documentation, Siemens provides a comprehensive support solution at:

- Service&Support (<http://www.siemens.com/automation/service&support>)

Personal contact

If you have additional questions about the device, please contact your Siemens personal contact at:

- Partner (<http://www.automation.siemens.com/partner>)

To find the personal contact for your product, go to "All Products and Branches" and select "Products & Services > Industrial Automation > Process Instrumentation".

Documentation

You can find documentation on various products and systems at:

- Instructions and manuals (<http://www.siemens.com/processinstrumentation/documentation>)

See also

Product information on SITRANS P in the Internet (<http://www.siemens.com/sitransp>)

Process instrumentation catalog (<http://www.siemens.com/processinstrumentation/catalogs>)

E-mail (<mailto:support.automation@siemens.com>)

A.2 Certificates

You can find certificates on the Internet at Certificates (<http://www.siemens.com/processinstrumentation/certificates>) or on an included DVD.

Index

C

Certificates, 7, 34
Compact Operating Instructions, 33
Correct usage, (See improper device modifications)
Customer Support, (Refer to Technical Support)

D

Disposal, 25
Documentation, 33

H

Hazardous area
 Laws and directives, 7
 Qualified personnel, 8
Hotline, (Refer to Support request)

I

Improper device modifications, 8
Instructions and manuals, 33

L

Laws and directives
 Disassembly, 7
 Personell, 7

M

Manuals, 33

N

Nameplate, 11

O

Operating Instructions, 33

Q

Qualified personnel, 8

R

Return procedure, 24

S

Scope of delivery, 5
Service, 33
Service & Support, 33
 Internet, 33
Support, 33
Support request, 33

T

Technical Support, 33
 Partner,
 Personal contact, 33
Test certificates, 7

W

Warranty, 6

