



SERVOFLEX 5200 MiniMP OPERATOR MANUAL

Part Number: 05230001A
Revision: 9
Language: UK English



LIST OF CONTENTS

Section		Page
1	DESCRIPTION AND DEFINITIONS	1
1.1	Scope of this manual	1
1.2	Safety information	1
1.3	Description	1
1.4	Sample measurement configurations	2
1.5	Other product options	2
2	SPECIFICATION	5
2.1	General	5
2.2	Sample gas	6
2.3	Calibration gases	7
2.4	Environmental limits	8
2.5	Performance: standard oxygen sensor	9
2.6	Performance: industrial oxygen sensor (standard Multi Purpose only)	10
2.7	Performance: high accuracy oxygen sensor	11
2.8	Performance: IR (infrared) sensors	12
2.9	Rechargeable battery (optional feature)	13
2.10	milliAmp outputs (optional feature)	13
3	UNPACK THE MULTI PURPOSE	14
4	MULTI PURPOSE USER INTERFACE	15
4.1	Introduction	15
4.2	Start-up and measurement screens	15
4.3	Soft key legends	17
4.4	Status icon bar	18
4.5	Scroll bars	19
4.6	Menu options/screens and password protection	19
4.7	The Menu screen	21
4.8	The Settings screen	22
4.9	The Information screen	22
4.10	Editing on-screen data	23
5	INSTALLATION AND SET-UP	24
5.1	Installation and switch-on	24
5.2	Charging/recharging the battery (Multi Purpose with optional rechargeable battery)	26
5.2.1	Charging	26
5.2.2	Recharging	26
5.3	Multi Purpose set-up	27
5.3.1	Selecting the security level and changing the password(s)	27
5.3.2	Setting the clock	30
5.3.3	Changing regional settings	31
5.3.4	Selecting power save mode (Multi Purpose with optional rechargeable battery)	32

CONTENTS (CONTINUED)

Section	Page
5.3.5	Selecting pump operation (Multi Purpose HF or standard Multi Purpose with optional internal sample pump) 33
6	GENERAL OPERATION 35
6.1	Calibrating the Multi Purpose. 35
6.2	Taking sample readings. 38
6.3	Correcting oxygen measurement for different background gases . 39
6.3.1	Overview of measurement errors 39
6.3.2	Entering a cross-interference compensation 39
6.4	Selecting display units 41
6.5	Configuring the measurement alarms 43
6.5.1	Alarm modes and levels 43
6.5.2	Latching/non-latching alarms. 43
6.5.3	Hysteresis levels 44
6.5.4	Setting the measurement alarm levels and modes 45
6.5.5	Enabling/disabling the audible measurement alarm 46
6.5.6	Silencing (muting) the audible measurement alarm 46
6.5.7	Unlatching measurement alarms. 47
6.5.8	Viewing the measurement alarm status. 47
6.6	Configuring and using the milliAmp outputs (optional feature) . . . 48
6.6.1	Overview 48
6.6.2	Introduction to the milliAmp output parameters 49
6.6.3	Set up the milliAmp output parameters 50
6.6.4	Select the Range associated with a measurement 51
6.6.5	Calibrate a milliAmp output 52
6.6.6	Check a milliAmp output 53
6.7	Data logging, serial outputs and printed outputs 54
6.7.1	Selecting data logging/serial output/printed outputs 54
6.7.2	Configuring the serial output parameters. 55
6.7.3	Introduction to data logging 56
6.7.4	Entering measurement data into the data log 56
6.7.5	Starting a new data log batch 57
6.7.6	Outputting the data log 57
6.7.7	Viewing the data log 58
6.7.8	Clearing the data log 58
6.7.9	Printing a sample measurement report 59
6.8	Adjusting the display 59
6.8.1	Adjusting the backlight timer 59
6.8.2	Adjusting the contrast 60
6.9	Switching off the Multi Purpose after use 60
7	ROUTINE MAINTENANCE 61
7.1	Cleaning the Multi Purpose 61
7.2	Inspecting the inlet filter element. 61
7.3	Regenerate/replace the drying agent 62
7.4	Use of the Multi Purpose for carbon monoxide measurements. . . 63
7.5	Preventative maintenance 64

CONTENTS (CONTINUED)

Section		Page
8	FAULT FINDING	65
8.1	Introduction to faults and fault messages	65
8.2	Viewing fault messages	68
8.3	General fault finding	68
9	STORAGE AND DISPOSAL	74
9.1	Storage	74
9.2	Disposal	74
10	SPARES	75
APPENDICES		
A1	DATA LOG OUTPUT FORMATS	76
A2	SERIAL OUTPUT FORMATS	78
A3	PRINTER OUTPUT FORMATS	79
A4	RS232 CONNECTION DETAILS	81
A4.1	Overview	81
A4.2	Connecting the Multi Purpose to a PC	81
A4.3	Capturing data using Windows® and Hyper Terminal™	82
A5	DISPLAY UNIT CONVERSION FACTORS	83
A6	OPTIONAL FLOWMETERS	84
A6.1	Overview	84
A6.2	Specification	84
A6.3	Preparing the Multi Purpose with a flowmeter	84
A6.4	Using the Multi Purpose with a flowmeter	86
A6.5	Multi Purpose HF and standard Multi Purpose with a sample pump	86
A6.6	Standard Multi Purpose without a sample pump	86
A7	OPTIONAL SAMPLE CONDITIONING PANEL	87
A7.1	Overview	87
A7.2	Specification	87
A7.3	Using the Multi Purpose with the sample conditioning panel	88
A7.4	Calibrating	88
A7.5	Sampling gases	88
A7.6	Additional maintenance	90
A7.7	Draining the catchpot	90
A7.8	Replacing/regenerating the drying agent	90
A7.9	Additional spares	91

CONTENTS (CONTINUED)

Section		Page
A8	OPTIONAL GAS PROBE ACCESSORY	92
A8.1	Overview	92
A8.2	Preparing for use	92
A8.3	Using the probe	92
A8.4	Additional maintenance	92
A8.5	Additional spares	93
A9	MATERIALS IN CONTACT WITH SAMPLE AND CALIBRATION GASES	94
A10	DISPOSAL IN ACCORDANCE WITH THE WASTE ELECTRICAL AND ELECTRONIC EQUIPMENT (WEEE) DIRECTIVE	96
A11	COMPLIANCE AND STANDARDS INFORMATION	97

® Drierite is a registered trademark of W A Hammond Co.

® Krytox and Viton are registered trademarks of Dupont.

® Kynar is a registered trademark of Elf Atochem North America, Inc.

® Windows and Excel are registered trademarks of Microsoft Corporation.

™ HyperTerminal is a trademark of Hilgraeve Inc.

© This manual is copyright, and no part of it may be reproduced without Servomex's written approval.

1 DESCRIPTION AND DEFINITIONS

1.1 Scope of this manual

This manual provides installation, operation and routine maintenance instructions for the Servomex 5200 Multi Purpose and 5200 Multi Purpose HF Gas Analysers, abbreviated to "Multi Purpose" and "Multi Purpose HF" where applicable in the remainder of this manual. Note that, unless otherwise stated, "Multi Purpose" is used to mean both versions of analyser in the remainder of this manual.

1.2 Safety information

Read this manual and ensure that you fully understand its content before you attempt to install, use or maintain the Multi Purpose. Important safety information is highlighted in this manual as WARNINGS and CAUTIONS, which are used as follows:

	WARNING
Warnings highlight specific hazards which, if not taken into account, may result in personal injury or death.	

CAUTION
Cautions highlight hazards which, if not taken into account, can result in damage to the Multi Purpose or to other equipment or property.

This manual also incorporates 'Be aware of' information, which is used as follows:

- + This highlights information which it is useful for you to be aware of (for example, specific operating conditions, and so on).

1.3 Description

	WARNING
This analyser is not a medical device as defined in the medical devices directive 93/42/EEC and is not intended to be used on human beings for the diagnosis, prevention, monitoring, treatment or alleviation of disease, injury or replacement or modification of the anatomy.	

	WARNING
The Multi Purpose must not be used as personal protective equipment.	

The Multi Purpose is a lightweight gas analyser, suitable for the needs of field and laboratory analysis, and light industrial users who require fast, accurate and reliable gas analysis.

The Multi Purpose uses paramagnetic transducers to determine the oxygen content of gas samples in concentrations up to 100%, and uses infrared transducers to determine the carbon dioxide (CO₂) or carbon monoxide (CO) content of gas samples in concentrations of up to 100% CO₂ or 5% CO.

The Multi Purpose is simple to operate, with an intuitive user interface (see Section 4).

Gas sample measurements are shown on the Multi Purpose display, and can also be output to a serial device connected to the Multi Purpose, or as optional milliAmp outputs.

The Multi Purpose requires little routine maintenance (see Section 7), other than calibration (which is essential for the accuracy of sample gas measurements) and regular inspection of the inlet filter element.

1.4 Sample measurement configurations

The Multi Purpose can be supplied configured to determine one or two gas sample measurements; the four possible sampling configuration combinations are as follows:

	Measurement 1 gas	Measurement 2 gas
1-measurement Multi Purpose	Oxygen *	(not applicable)
	IR †	(not applicable)
2-measurement Multi Purpose	Oxygen *	IR †
	IR †	IR †

* Standard, industrial or high-accuracy sensor: see Sections 2.5 to 2.7.
Note that the Multi Purpose HF cannot be supplied with an industrial oxygen sensor.

† Carbon monoxide or carbon dioxide: see Section 2.8.

1.5 Other product options

The standard Multi Purpose can be supplied with the following options:

- With an internal sample pump
- With the sample gas outlet on the front or rear of the Multi Purpose
- With a rechargeable battery
- With a printer
- With milliAmp outputs
- With a flowmeter fitted
- With a sample conditioning panel fitted
- With a gas probe accessory
- Protective transport case

The Multi Purpose HF is designed for higher gas flow rates and is supplied with an internal sample pump fitted.

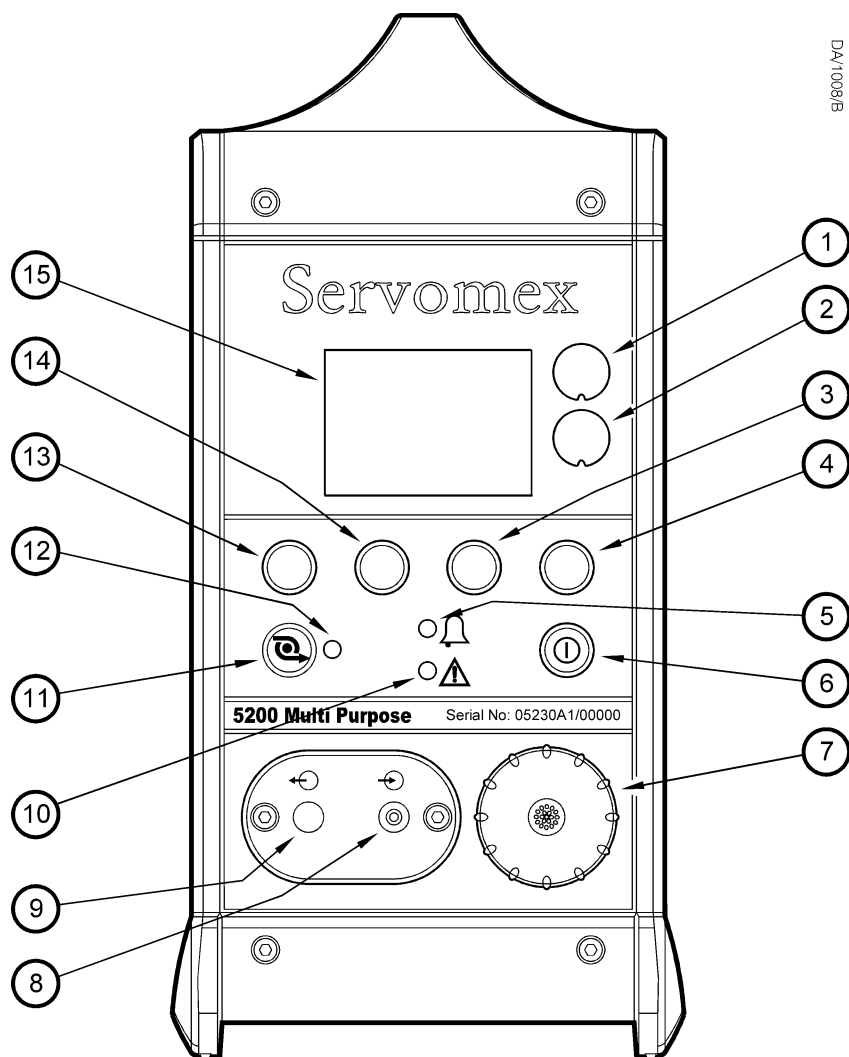

Key	Description	Key	Description
1.	Sample gas 1 label *	9.	Sample gas outlet † ‡
2.	Sample gas 2 label *	10.	Fault LED (amber)
3.	Soft key 3	11.	Sample pump key †
4.	Soft key 4	12.	Sample pump LED (green) †
5.	Alarm LED (red)	13.	Soft key 1
6.	Power On/Off key	14.	Soft key 2
7.	Filter retaining cap	15.	Display
8.	Sample gas inlet		

* The legends on the labels show the sample gases for which the Multi Purpose is configured.

† Only available if an internal sample pump is fitted.

‡ Only fitted if the front sample gas outlet option was specified when you ordered your Multi Purpose.

Figure 1 - Front of the Multi Purpose

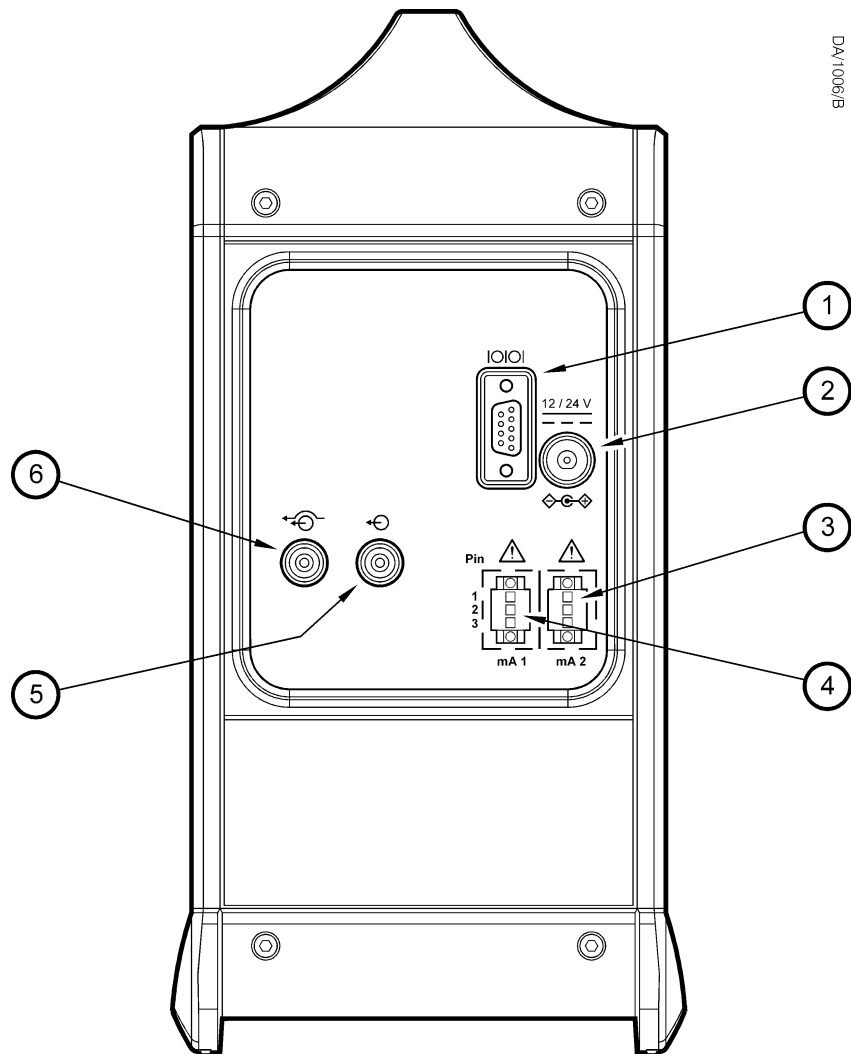

Key	Description	Key	Description
1.	Serial output port	4.	milliAmp output socket 1 †
2.	Power inlet	5.	Sample gas outlet ‡
3.	milliAmp output socket 2 *	6.	Bypass gas outlet #

* Only fitted if the 5200 Multi Purpose includes 2 optional milliAmp outputs.

† Only fitted if the 5200 Multi Purpose includes 1 or 2 optional milliAmp outputs.

‡ Not fitted if the front sample gas outlet option was specified when you ordered your Multi Purpose.

Not fitted to a standard Multi Purpose with an internal sample pump.

Figure 2 - Rear of the Multi Purpose

2 SPECIFICATION



WARNING

You must install and use the Multi Purpose in accordance with the requirements of this section and subsequent sections of the manual. If you do not, the protection facilities incorporated into the design of the Multi Purpose may not operate as intended, sample gas measurements may not be accurate, or the Multi Purpose may be damaged.

The SERVOFLEX Mini MP (5200) must be used with a mains supply in order to comply with TUV/UBA in accordance to QAL1 in EN14181 and EN15267-3.

2.1 General

Dimensions:	
height x width x depth	300 x 150 x 260 mm (12 x 6 x 10.5 in.)
Mass (maximum)	2.6 to 3.9 kg (5.7 to 8.6 lb)
Electrical supply requirements	
Power supply unit	100 to 240 V a.c., 47 to 63 Hz (nominal)
Multi Purpose	12 to 24 V d.c., 20 W (maximum) *
Minimum gas flow rate †	
Standard Multi Purpose (with internal sample pump)	700 ml min ⁻¹ (0.025 ft ³ min ⁻¹)
Multi Purpose HF	1.8 l min ⁻¹ (0.065 ft ³ min ⁻¹)

* As supplied by the power supply unit (through a centre pin +ve connector).

† Measured at the sample gas inlet, with no accessories fitted to the inlet.

2.2 Sample gas

	<p>WARNING</p> <p>If you sample carbon monoxide, the quantity of gas sampled by the Multi Purpose may be above the short term exposure limit for carbon monoxide, and so the sample should be considered to be toxic. Similarly, other sample and calibration gases which you use may also be considered as toxic. You must therefore carry out your own risk assessment before you use the Multi Purpose with such gases. The maximum inlet pressure of such toxic gases is 34.5 kPa gauge (5 psig, 0.35 bar gauge).</p>
---	--

Pressure range

without internal sample pump (see WARNING above)	6.9 to 68.9 kPa gauge (1 to 10 psig) (0.07 to 0.69 bar gauge)
with internal sample pump	-3.4 to 3.4 kPa gauge (max) (-0.5 to 0.5 psig) (-0.03 to 0.03 bar gauge)
Dew point	Less than (ambient temperature minus 10 °C) Less than (ambient temperature minus 50 °F)
Particulate size	Less than 2 µm

2.3 Calibration gases

Low calibration gas	Oxygen-free nitrogen, 99.9% pure
High calibration gas	
Standard oxygen sensor	Certified oxygen supply * or instrument quality air †, or other supply (with > 20% oxygen; for example ambient air)
Industrial or high accuracy oxygen sensor	Certified oxygen supply * or instrument quality air †, or other supply (with > 1% oxygen)
IR (infrared) sensor	Certified gas supply with a concentration in the range 80 to 100% of the corresponding IR sensor max measurement (see Section 2.8)
Calibration gas flow rate (with internal sample pump fitted)	
Minimum	1 l min ⁻¹ (0.035 ft ³ min ⁻¹)
Maximum	2.5 l min ⁻¹ (0.088 ft ³ min ⁻¹)
Calibration gas pressure range	
Standard Multi Purpose #	6.9 to 68.9 kPa gauge (1 to 10 psig, 0.07 to 0.69 bar gauge)
Multi Purpose HF	
Minimum	6.89 kPa gauge (1 psig, 0.07 bar gauge)
Maximum	34 kPa gauge (5 psig, 0.34 bar gauge)

* > 99.2% pure oxygen, with nitrogen balance gas.

† The air supply must be clean and dry, and free from oil.

Without internal sample pump.

+ With an industrial or high accuracy oxygen sensor, there must be at least a 1% difference in oxygen concentration between the low and high calibration gases. With the standard oxygen sensor, there must be at least a 20% difference in oxygen concentration between the low and high calibration gases.

2.4 Environmental limits

Ambient temperature range	
Operation (analyser)	-10 to +50 °C (14 to 122 °F)
Operation (power supply unit)	0 to 50 °C (32 to 122 °F)
Battery charging	+10 to +40 °C (50 to 104 °F)
Storage *	-20 to +60 °C (-4 to 140 °F)
Operating ambient pressure range	1.013 x 10 ² kPa ±10% (1.013 bar ±10%) (14.69 psi ±10%)
Operating ambient humidity range	0 to 95% RH, non-condensing
Operating altitude range	-500 † to 5000 ‡ meters (-1640 † to 16400 ‡ feet)
Ingress protection	IP40

* Storage below 21 °C (70 °F) is recommended to ensure optimum battery life.

† Below sea level.

‡ Above sea level.

2.5 Performance: standard oxygen sensor

- + The display indication given below is the default indication. You can configure the Multi Purpose to provide other display indications (see Section 6.4).

Display indication	Measured volume % oxygen
Full Scale Range	0 to 100% oxygen
Resolution	0.1% oxygen
Linearity	$\pm 0.1\%$ oxygen
Intrinsic error (accuracy)	$\pm 0.1\%$ oxygen *, or $\pm 0.2\%$ oxygen †
Zero drift per week	$\pm 0.4\%$ oxygen
Output fluctuation	$\pm 0.1\%$ oxygen
Response time: standard Multi Purpose #	
Without drying tube	Less than 10 seconds
With drying tube fitted	20 seconds
Response time: Multi Purpose HF #	
Without drying tube	8 seconds
With drying tube fitted	10 seconds
Flow effect ‡	$\pm 0.1\%$ oxygen for a ± 35 kPa gauge (0.5 psig, 0.35 bar gauge) change in sample gas supply pressure
Zero temperature coefficient	$\pm 0.2\%$ oxygen per 10 °C (18 °F)
Span temperature coefficient	$\pm 0.3\%$ oxygen per 10 °C (18 °F)
Tilt effects	$\pm 0.3\%$ oxygen per 22.5° of tilt
Pressure effects	Directly proportional to ambient barometric pressure §
Power cycle offset	$\pm 0.4\%$ maximum

* High calibration with certified oxygen supply (see Section 2.3).

† High calibration with instrument air or other oxygen supplies (see Section 2.3).

T₉₀ at 68.9 kPa gauge (10 psig, 0.69 bar gauge) supply pressure. Response time will increase if the Multi Purpose has a sample conditioning panel: refer to Section A7.2.

‡ Within sample gas supply pressure range specified in Section 2.2.

§ A 1% change in ambient barometric pressure will result in a 1% change in sample reading.

2.6 Performance: industrial oxygen sensor (standard Multi Purpose only)

- + The display indication given below is the default indication. You can configure the Multi Purpose to provide other display indications (see Section 6.4).

Display indication	Measured volume % oxygen
Full Scale Range	0 to 100% oxygen
Resolution	0.1% oxygen
Linearity	± 0.1% oxygen
Intrinsic error (accuracy)	± 0.1% oxygen
Zero drift per week	± 0.2% oxygen
Output fluctuation	± 0.1% oxygen
Response time *	
Without drying tube	15 seconds
With drying tube fitted	25 seconds
Flow effect †	± 0.1% oxygen
Zero temperature coefficient	± 0.2% oxygen per 10 °C (18 °F)
Span temperature coefficient	± 0.3% oxygen per 10 °C (18 °F)
Tilt effects	± 0.15% oxygen per 15° of tilt
Pressure effects	Directly proportional to ambient barometric pressure #

* T_{90} at 68.9 kPa gauge (10 psig, 0.69 bar gauge) supply pressure. Response time will increase if the Multi Purpose has a sample conditioning panel: refer to Section A7.2.

† Within sample gas supply pressure range specified in Section 2.2.

A 1% change in ambient barometric pressure will result in a 1% change in sample reading.

2.7 Performance: high accuracy oxygen sensor

- + The display indication given below is the default indication. You can configure the Multi Purpose to provide other display indications (see Section 6.4).

Display indication	Measured volume % oxygen
Full Scale Range	0 to 100% oxygen
Resolution	0.01% oxygen
Linearity	$\pm 0.01\%$ oxygen
Intrinsic error (accuracy)	$\pm 0.02\%$ oxygen *, or $\pm 0.05\%$ oxygen †
Zero drift per week	$\pm 0.2\%$ oxygen
Output fluctuation	$\pm 0.01\%$ oxygen
Response time: standard Multi Purpose #	
Without drying tube	15 seconds
With drying tube fitted	25 seconds
Response time: Multi Purpose HF #	
Without drying tube	Less than 10 seconds
With drying tube fitted	Less than 12 seconds
Flow effect ‡	$\pm 0.1\%$ oxygen
Zero temperature coefficient	$\pm 0.2\%$ oxygen per 10 °C (18 °F)
Span temperature coefficient	$\pm 0.3\%$ oxygen per 10 °C (18 °F)
Tilt effects	$\pm 0.15\%$ oxygen per 15° of tilt
Pressure effects	Directly proportional to ambient barometric pressure §

* High calibration with certified oxygen supply (see Section 2.3).

† High calibration with instrument air or other oxygen supplies (see Section 2.3).

T_{90} at 68.9 kPa gauge (10 psig, 0.69 bar gauge) supply pressure. Response time will increase if the Multi Purpose has a sample conditioning panel: refer to Section A7.2.

‡ Within sample gas supply pressure range specified in Section 2.2.

§ A 1% change in ambient barometric pressure will result in a 1% change in sample reading.

2.8 Performance: IR (infrared) sensors

- + The display indications given below are the default indications. You can configure the Multi Purpose to provide other indications (see Section 6.4). Allow 1 hour warm up to reach stated accuracy.

Display indication	
Carbon monoxide sensors	Measured volume % carbon monoxide
Carbon dioxide sensors	Measured volume % or ppm carbon dioxide
Full Scale Range *	
Carbon monoxide sensors	0 to 5%
Carbon dioxide sensors	0 to 10%, 0 to 25%, 0 to 50% or 0 to 100%
Resolution	Less than 0.1% Full Scale Range *
Linearity	± 1% Full Scale Range *
Intrinsic error (accuracy)	± 2% Full Scale Range *
Zero drift per week	± 4% Full Scale Range *
Output fluctuation	± 0.05% Full Scale Range *
Response time: standard Multi Purpose †	
Without drying tube	Less than 10 seconds
With drying tube fitted	75 seconds
Response time: Multi Purpose HF †	
Without drying tube	Less than 6 seconds
With drying tube fitted	Less than 10 seconds
Flow effect ‡	± 0.5% Full Scale Range *
Zero temperature coefficient #	± 1% Full Scale Range * per 10 °C (18 °F)
Span temperature coefficient #	
100% CO ₂ only	± 8.5% Full Scale Range per 10 °C (18 °F)
All other IR measurements	± 5% Full Scale Range per 10 °C (18 °F)
Tilt effects	± 1% Full Scale Range * per 15° of tilt
Pressure effects	Less than 0.2% measurement per 0.1 kPa (1 mbar, 1.45 x 10 ⁻² psi) change in ambient barometric pressure

* The ranges listed identify the different IR sensors available.

† T₉₀ at 68.9 kPa gauge (10 psig, 0.69 bar gauge) supply pressure. Response time will increase if the Multi Purpose has a sample conditioning panel: refer to Section A7.2.

‡ Within sample gas supply pressure range specified in Section 2.2.

In the range 5 to 45 °C (41 to 113 °F).

2.9 Rechargeable battery (optional feature)

Battery type	Lithium ion
Time to recharge (from empty)	4 hours *
Operating life (from fully charged)	8 to 35 hours †
Service life	Approximately 300 to 500 discharge/recharge cycles (depending on ambient conditions)

* This is the recharge time with the Multi Purpose switched off. With the Multi Purpose switched on, recharge time depends on ambient conditions, and on the Multi Purpose configuration and usage.

† Battery operating life depends on the Multi Purpose configuration (that is, the options that are fitted), and how the Multi Purpose is used.

+ Lithium ion batteries have no 'memory effects', so you can recharge the battery, from any charge level, for any length of time and for often as you like, without affecting the battery's service life.

To ensure the optimum service life of the battery, we recommend that you recharge the battery after each session of operation, and that you store the Multi Purpose when not in use in a cool environment: see Section 2.4.

2.10 milliAmp outputs (optional feature)

Maximum load resistance	1 k Ω
Minimum isolation voltage	500 V
Output range	
Normal sample measurement	0 to 20 mA or 4 to 20 mA *
Fault condition	0 mA or 21.5 mA *
Under range †	Less than 4 mA
Cable requirements	
Type	Multi-strand twisted pair with overall screen
Maximum size	1.5 mm ² 16 AWG

* User selectable: see Sections 6.6.2 and 6.6.3.

† Only available when the 4 to 20 mA output range is selected: see Sections 6.6.2 and 6.6.3.

3 UNPACK THE MULTI PURPOSE

1. Remove the Multi Purpose and any other equipment from its packaging.
2. Remove the protective plastic cover from the sample gas inlet on the front of the Multi Purpose (see Figure 1).
3. Remove the protective plastic cover from the sample gas outlet (on the front or the rear of the Multi Purpose: see Figures 1 and 2).
4. Remove the protective plastic cover from the bypass gas outlet (if fitted) on the rear of the Multi Purpose (see Figure 2).
5. Inspect the Multi Purpose and the other items supplied, and check that they are not damaged. If any item is damaged, immediately contact Servomex or your local Servomex agent.
6. If you do not intend to use the Multi Purpose immediately:
 - Refit the protective plastic covers to the gas inlet, the sample gas outlet and the bypass gas outlet (if fitted).
 - Place the Multi Purpose and any other equipment supplied back in its protective packaging.
 - Store the Multi Purpose as described in Section 9.1.

Otherwise, read Section 4 (User Interface), then continue at Sections 5 onwards to install, set up, and use the Multi Purpose.

- + Retain the shipping documentation and packaging for future use (for example, return of the Multi Purpose to Servomex for servicing or repair).

CAUTION

You must remove the protective plastic covers as specified in Steps 3 and 4 above before you use the Multi Purpose. If you do not, you may damage the Multi Purpose when you try to pass calibration or sample gases through it.

4 MULTI PURPOSE USER INTERFACE

- + Throughout this manual, reference is made to product options (such as "rechargeable battery") which must be specified at the time of purchase. Associated menus and menu options will not be available if your Multi Purpose does not have the corresponding product options.

4.1 Introduction

The Multi Purpose user interface comprises the following (shown on Figure 1):

Power On/Off key	Use this key to switch the Multi Purpose on (see Section 5.1) or to switch it off (see Section 6.9).
Display	Shows various screens: see Section 4.2 onwards.
Soft keys	The function of each of the soft keys depends on the screen currently being shown on the display: see Section 4.2.
Alarm LED	On when an alarm condition exists: see Section 6.5.4.
Fault LED	On when a fault condition exists: see Section 8.
Sample pump key *	Use this key to switch the sample pump on and off: see Section 5.3.5.
Sample pump LED *	Flashes when the sample pump is operating: see Section 5.3.5.

* This key and LED are only operational if an internal sample pump is fitted.

The Multi Purpose also has an audible alarm which will go on (emit a tone):

- On initial switch-on: see Section 5.1.
- When a measurement alarm condition is detected (if the audible measurement alarm is enabled): see Section 6.5.5.
- When a fault condition is detected: see Section 8.

4.2 Start-up and measurement screens

When you first switch on the Multi Purpose, a 'start-up screen' is displayed while the Multi Purpose carries out a self-test.

The start-up screen shows the Servomex name, a 'self-test time elapsed/remaining' indicator, and messages identifying the tasks being carried out as part of the self-test:

- The screen will initially display the message "System Check".
- If your Multi Purpose is configured for use with one or more IR sensors, the following messages will be displayed: "Infrared Initialising" and "Infrared Warming".

The Measurement screen is then displayed, as shown in Figure 3 below. Note that:

- If your Multi Purpose is configured for a single sample gas measurement, the 1-measurement screen will be shown, as in detail A below.
- If your Multi Purpose is configured for two sample gas measurements, the 2-measurement screen will be shown, as in detail B below.

(Continued on page 17)

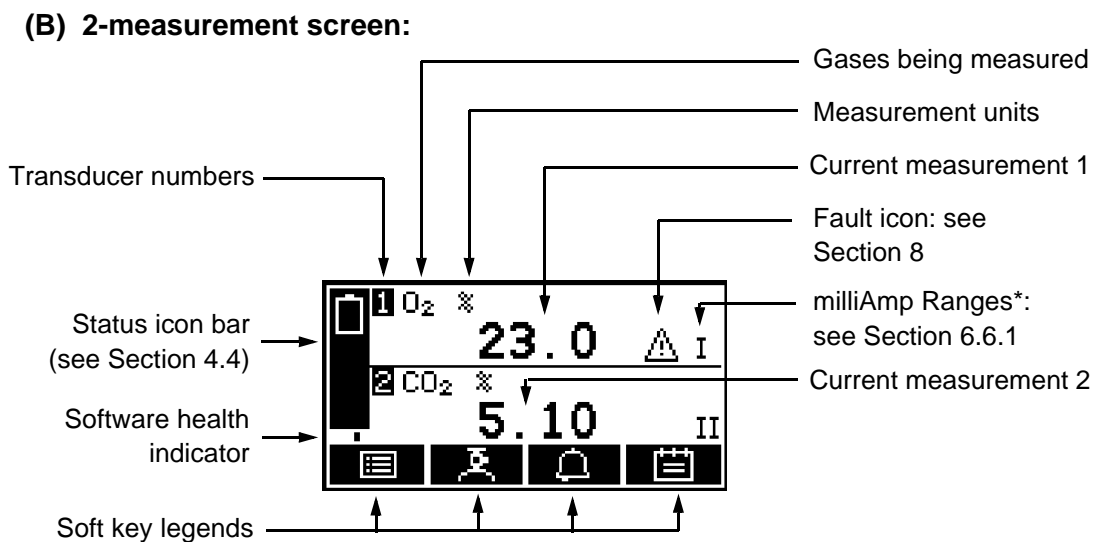
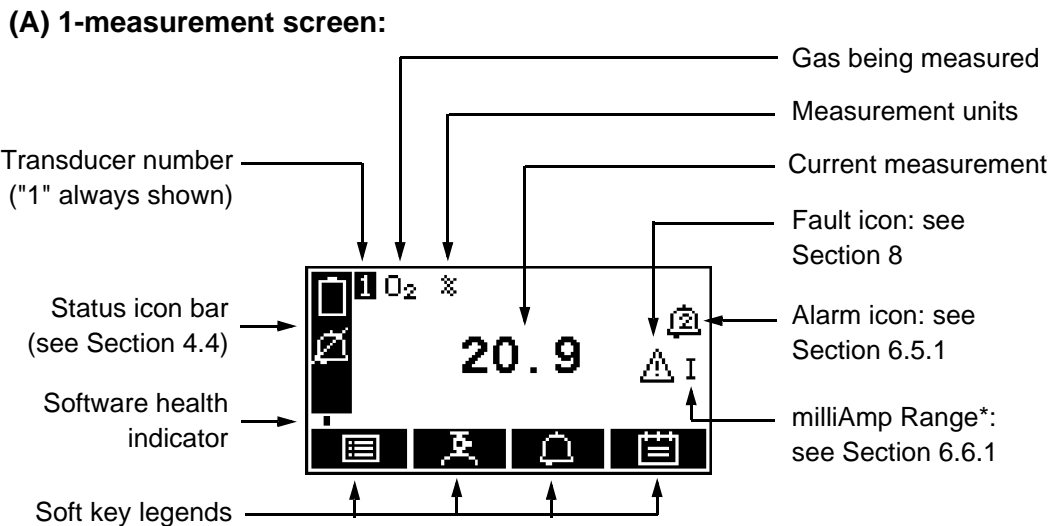

* Optional feature





Figure 3 - The Measurement screen

- + During normal Multi Purpose operation, the software health indicator continuously moves from left to right and then back again, below the status icon bar. If the indicator stops moving, this means that the Multi Purpose is not operating correctly, and you must refer to Section 8.
- + If no soft key is pressed for 10 minutes, the Measurement screen will be automatically displayed. (You will also then have to enter the password again to access any password-protected screens: refer to Figure 4 and to Section 4.6.)

4.3 Soft key legends

The four soft key legends at the bottom of the Measurement screen (Figure 3) correspond to the four soft keys on the front of the Multi Purpose. (The first legend corresponds to the function of soft key 1, the second legend corresponds to the function of soft key 2, and so on).









On the Measurement screen, the soft key functions are as follows:

Legend	Meaning	Function (when soft key pressed)
	Menu	Displays the Menu screen: see Section 4.7.
	Calibrate *	Displays the Calibrate screen: see Section 6.1.
	Alarm *	Displays the Alarm option screen: see Section 6.5.4.
	Logging †	Displays the Data logging screen: see Section 6.7.
	Print †	Produces a printed sample measurement report: see Section 6.7.9.

* These soft keys are 'shortcuts' to these menus, which can also be selected by pressing the  soft key with the corresponding menu option highlighted on the Menu screen: see Section 4.7.







† If you have selected printed outputs (see Section 6.7.1), the 'Print' legend is shown instead of the 'Logging' legend.

Other soft key legends which are used on the various screens are as follows:

Legend	Meaning	Function (when soft key pressed)
	Back	Cancels the current screen and displays the previous screen in the menu structure.
	Accept	Accepts the currently selected option or data. (A new screen may be displayed accordingly.)
	Edit	Allows the highlighted data to be edited.
	Batch	Starts a new batch (for data logging).
	Up	Moves the cursor up a list (or increases a digit during editing).
	Down	Moves the cursor down a list (or decreases a digit during editing).
	Left	Moves the cursor left.
	Right	Moves the cursor right.

4.4 Status icon bar

The status icon bar appears on all screens. The icons which can be shown and their meanings are as follows:



Icon	Meaning
	Indicates that a fault has been detected by the Multi Purpose: refer to Section 8.
	Indicates that the audible alarm is disabled: refer to Section 6.5.5.
 *	Battery less than 10% full.
 *	Battery 10% to 32% full.
 *	Battery 33% to 65% full.
 *	Battery 66% to 100% full.

* These icons will only be shown on a Multi Purpose with the optional rechargeable battery fitted. See Section 5.2 for more information.

+ When the 'battery less than 10% full' icon starts to flash, this indicates that the rechargeable battery is virtually empty. The Multi Purpose will automatically shut down approximately 15 seconds after the icon starts to flash.

4.5 Scroll bars

On some screens (for example, see Figure 5), there may be more options available than can be shown on the screen, and you have to scroll down the screen to view all of the options: this is identified by a scroll bar at the right-hand side of the screen.

The height of the wide part of the scroll bar gives an indication of what proportion (of all the options) are currently shown on the screen. As you scroll up or down the options (using the  and  soft keys), the wide part of the scroll bar will also move on the screen, indicating approximately where the currently displayed options are, within the complete list of options. For example, compare the scroll bars in Figures 5 and 13.

4.6 Menu options/screens and password protection

The menu structure of the Multi Purpose is shown in Figure 4, which shows that some of the options/screens are password protected.

When an option/screen is password protected, this means that the correct corresponding password has to be entered before the option/screen can be accessed.

Password protection operates as follows:

- The first time you try to access a password-protected option/screen, you will be prompted for the corresponding password. You must then enter the correct password (using the editing method described in Section 4.10) before the option/screen can be displayed.
 - If you have already entered the corresponding password, you will gain access to all options/screens protected by that password immediately (you do not need to enter the password again).
- + Once you have entered a password, it remains active until 10 minutes after the last soft key is pressed. After this, the password becomes inactive; you must re-enter the password to access password-protected options/screens again.

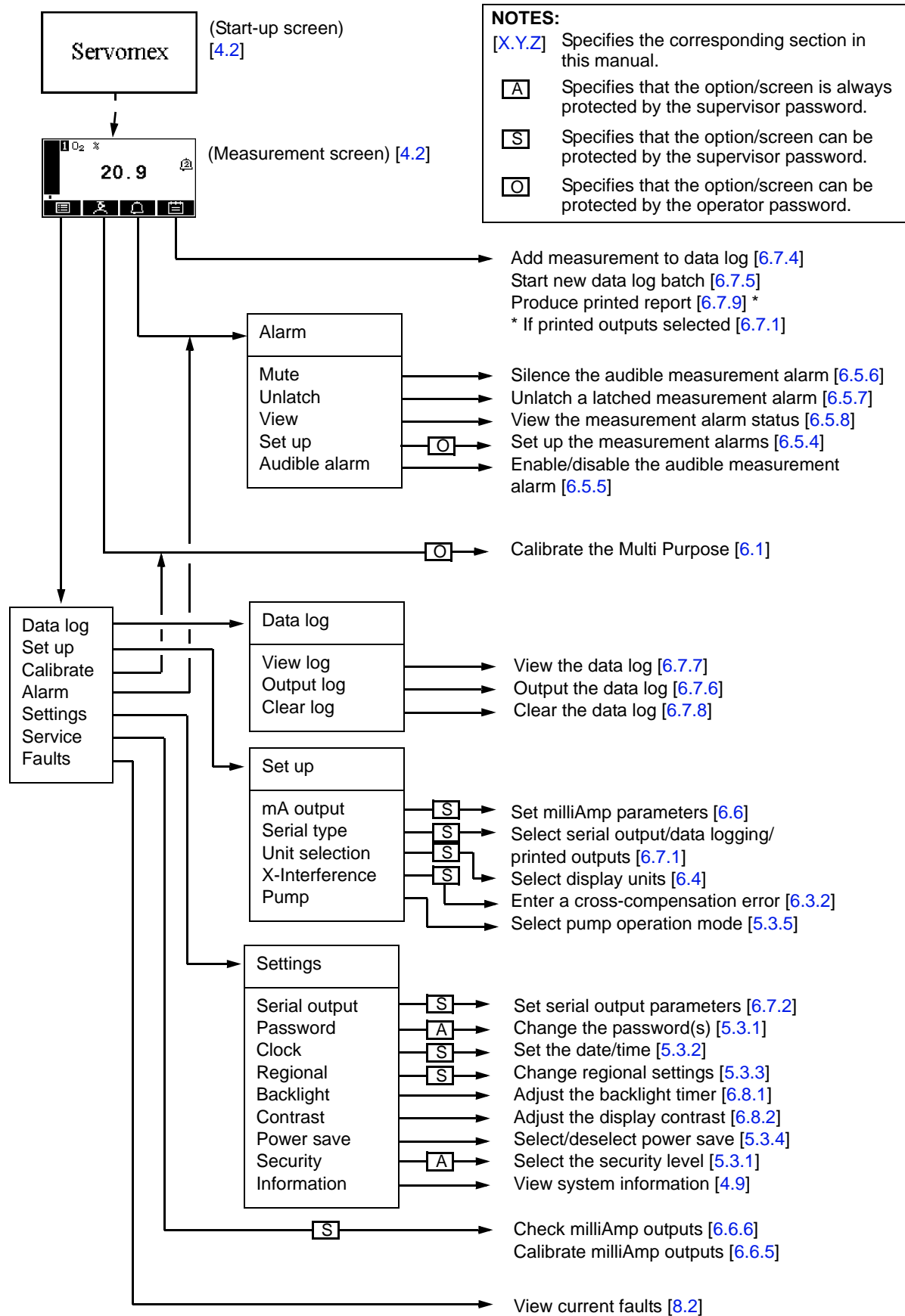



Figure 4 - The Multi Purpose menu structure

4.7 The Menu screen

- + Some of the menu screens referenced below may not be available: refer to the note at the start of Section 4.

The Menu screen (see Figure 5) provides access to other screens in the menu structure, and is displayed by pressing the  soft key when the Measurement screen is displayed.

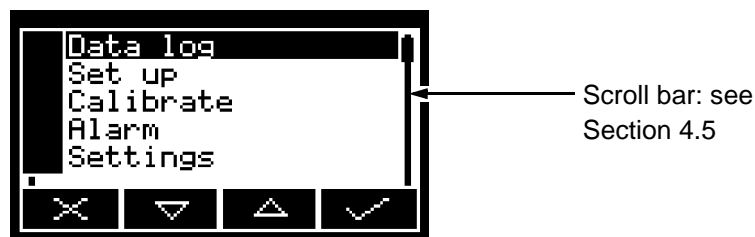





Figure 5 - The Menu screen



Use the  and  soft keys to highlight the required screen option, then press the  soft key to display the selected screen:

Screen	Use	Section
Data Log	Select this screen to view, output or clear the data log.	6.7.6 to 6.7.8
Set up	Select this screen to configure the (optional) milliAmp outputs, select serial output, data logging or printed outputs, select the display units, or introduce a cross-interference correction.	6.6.3, 6.7.1, 6.4, 6.3.2
Calibrate	Select this screen to calibrate the Multi Purpose.	6.1
Alarm	Select this screen to set up the measurement alarms, or to silence (mute) the audible measurement alarm.	6.5.4
Settings	Select this screen to change Multi Purpose settings (password, display language and so on).	4.8
Service	Select this screen to calibrate or check the (optional) milliAmp outputs.	6.6.5, 6.6.6
Faults	Select this screen to view current faults.	8.2

Alternatively, press the  soft key to display the Measurement screen again.

4.8 The Settings screen

The Settings screen is shown in Figure 6.

Use the  and  soft keys to highlight the required screen option, then press the  soft key to display the selected screen, as shown below:

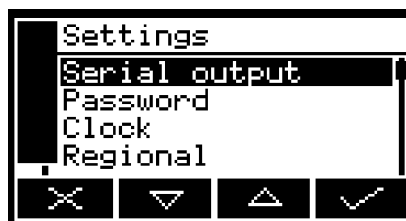

Figure 6 - The Settings screen

Screen	Use	Section
Serial output	Configuring the serial output parameters	6.7.2
Password	Changing the password.	5.3.2
Clock	Setting the clock time and/or date.	5.3.2
Regional	Changing regional settings (language and so on).	5.3.3
Backlight	Adjusting the backlight timer duration.	6.8.1
Contrast	Adjusting the contrast of the screen.	6.8.2
Power save *	Selecting/deselecting 'power save' operation.	5.3.4
Security	Selecting the security level.	5.3.1
Information	Viewing Multi Purpose system information.	4.9

* Only available on a Multi Purpose with the optional rechargeable battery fitted.

Alternatively, press the  soft key to display the Menu screen again.

4.9 The Information screen

A typical Information screen is shown in Figure 7.

This screen shows information (such as the Multi Purpose serial number and the version of the operating software embedded in the Multi Purpose) which is useful to the Servomex support team.

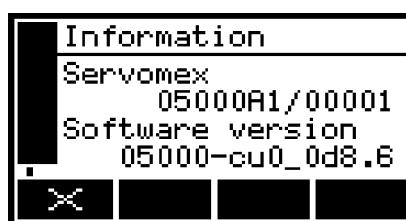



Figure 7 - Typical information screen

Note that the information shown on the screen will vary, depending on the Multi Purpose model.

After viewing (and if necessary recording) the information shown on the screen, press the  soft key to display the Settings screen again, or press and hold the  soft key to show the Measurement screen again.

- + You may be asked to provide the information from this screen to the Servomex support team; for example, as an aid to fault diagnosis.

4.10 Editing on-screen data

A common method is used for editing data shown on all of the different screens.







When you press the  soft key to edit an item of data, the screen changes to show the corresponding edit screen, with the first digit highlighted; a typical edit screen is shown in Figure 8:



Figure 8 - A typical edit screen

When the first digit is highlighted, press the  soft key to exit the menu without changing the data.

Alternatively, use the soft keys to edit the data as follows:

Soft key	Function
	Increases the highlighted digit by 1.
	Decreases the highlighted digit by 1.
	Moves the cursor left to the previous digit.
	Moves the cursor right to the next digit.





Note that the figures above and below the highlighted digit show the digits above and below the currently highlighted value.

When the last digit is highlighted, press the  soft key to enter the new data.

- + When editing numerical values, the decimal point appears between digits "9" and "0".

5 INSTALLATION AND SET-UP

5.1 Installation and switch-on

	WARNING Ensure that the cables and tubes that you connect to the Multi Purpose are routed so that they do not present a trip hazard to people.
	WARNING Ensure that the electrical installation of the Multi Purpose and the power supply unit conforms with all applicable local and national electrical safety requirements.
	WARNING Sample and calibration gases may be toxic or asphyxiant. Ensure that the external connections are leak free at full operating pressure before you use sample or calibration gases.
	WARNING Sample and calibration gases may be toxic or asphyxiant. Ensure that the Multi Purpose sample, bypass gas and calibration 'T' piece (if used) outlets are vented to an area where they will not be a hazard to people.
	WARNING Sample and calibration gases may be toxic or asphyxiant. To prevent the build-up of such gases, ensure that the Multi Purpose is only used in a well-ventilated environment.
CAUTION	
Do not use the Multi Purpose in an area subject to high levels of vibration or sudden jolts. If you do, sample measurements may not be accurate, or the Multi Purpose may be damaged.	

1. Place the Multi Purpose in a suitable operating location, within easy reach of a suitable electrical supply outlet.
2. If necessary (if sample or calibration gases are toxic or asphyxiant) or if required:
 - Use quick-connect fittings to connect a suitable sized tube to the sample gas outlet (on the rear or the front of the Multi Purpose: see Figures 1 and 2).
 - Use quick-connect fittings to connect a suitable sized tube to the bypass gas outlet (if fitted, on the rear of the Multi Purpose: see Figure 2).

3. If you have fitted tubes to the sample gas outlet and/or bypass gas outlet, route the ends of the tubes so that they can freely vent to atmosphere.
 - + The two outlets can be left to vent to local atmosphere. However if you do fit a tube to one or both of the outlets, the tube(s) must be suitably sized so that the gases can vent from the Multi Purpose without over-pressurisation of the Multi Purpose or the tubes.
4. If you have ordered and received a printer, connect the printer to the serial connector on the rear of the Multi Purpose (see Figure 2). Alternatively, if required, connect a PC (personal computer) or other device to the serial connector: refer to Appendix A4.
5. If your Multi Purpose is configured to provide optional milliAmp outputs, for each output:
 - Connect the wires in your cable to the screw terminals on the milliAmp interface connector supplied: refer to Section 2.10 for the cable requirements, and refer to Figure 9 below for the connection requirements.
 - Fit the interface connector to the corresponding milliAmp output connector on the rear of the Multi Purpose (see Figure 2), and secure with the two captive screws on the interface connector.
 - + If you have two milliAmp outputs, ensure that you fit the correct interface connector to the corresponding milliAmp connector on the rear of the Multi Purpose.

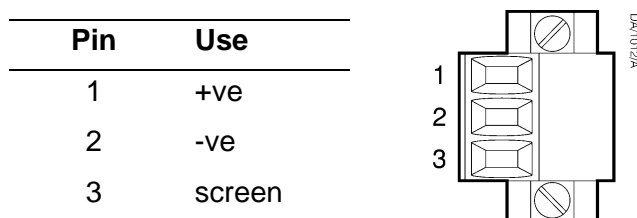

Figure 9 - milliAmp interface connector

6. Fit the power outlet on the power supply unit to the power socket on the rear of the Multi Purpose.
7. Fit the power supply unit plug to a suitable electrical supply outlet.
8. Press and hold the Power On/Off key on the front of the Multi Purpose for at least 2 seconds to switch the Multi Purpose on.
 - + When the Multi Purpose is switched on, the Alarm LED, the Fault LED and the audible alarm will all go on for 1 second to demonstrate that they are functioning correctly, and will then go off again.

5.2 Charging/recharging the battery (Multi Purpose with optional rechargeable battery)

5.2.1 Charging

The first time you use a Multi Purpose with the optional rechargeable battery, you should leave the Multi Purpose connected to the electrical supply for at least 4 hours, to fully charge the battery.

When the battery is fully charged, you can leave the Multi Purpose connected to the electrical supply, or you can disconnect the electrical supply and continue to use the Multi Purpose powered by the battery.

5.2.2 Recharging

- + We recommend that you recharge the battery as soon as possible after the 'battery less than 10% full' icon is displayed.

During normal use, the battery icon on the status icon bar of the display will identify the level of charge within the battery (see Section 4.4).

You can recharge the battery as and when required during normal use. To recharge the battery, simply connect the Multi Purpose to an external electrical supply outlet.

- + During recharging, the status icon bar will continually show the 'battery less than 10% full', 'battery 10 to 32% full', 'battery 33 to 65% full' and 'battery 66 to 100% full' icons in sequence.
- + You can recharge the battery with the Multi Purpose switched on or off. However, recharging will take longer when the Multi Purpose is switched on.

5.3 Multi Purpose set-up

When you switch on the Multi Purpose, a 'start-up screen' is first displayed (see Section 4.2), then the Measurement screen (Figure 3) is displayed.

When the Measurement screen is displayed, you can set up the Multi Purpose as described below.

5.3.1 Selecting the security level and changing the password(s)

Introduction to security levels/passwords

You can configure the Multi Purpose to provide any of three levels of security:

Security level	Function
Low	None of the options/screens are password protected *.
Standard	Some of the options/screens are protected by a supervisor password.
High	Some of the options/screens are protected by a supervisor password and some of the options/screens are protected by an operator password †.

* Except for the 'change the password(s)' and 'select the security level' options/screens: see notes below.

† The supervisor password can also be used to access options/screens protected by the operator password: see notes below.

- + The 'change the password(s)' and 'select the security level' screens/options are always protected by the supervisor password, regardless of the security level selected. This is to ensure that unauthorised personnel cannot change the security level and password(s) and so lock out the Multi Purpose from other users.
- + The supervisor password provides access to all password protected options/screens. That is, if you have selected the 'high' security level and are prompted to enter the operator password, you can also access the option/screen by entering the supervisor password.
- + Password protection can be used to prevent adjustment of the clock by unauthorised persons, so ensuring the validity of measurement times and the 'time since last calibration' history.

Figure 4 shows the options/screens which can be password-protected within the menu structure.

Selecting the security level

- + As supplied, the security level is set to 'high', the supervisor password is set to "2000" and the operator password is set to "1000". We recommend that you select your required security level and change the password(s) as described below to provide additional protection.

Before the Multi Purpose is used for sample measurement, we recommend that you select the security level (low, standard or high: see Section 4.6) most suitable for the way in which the Multi Purpose will be used by you and/or your personnel.

Use the following procedure to select the required security level:



1. With the Settings screen displayed, use the  and  soft keys to highlight the "Security" menu option, then press the  soft key. The Security level screen will then be displayed showing the currently selected level: see Figure 10.



Figure 10 - The Security level screen





2. To change the security level, press the  soft key. You will then be prompted to enter the supervisor password.
3. Once the supervisor password has been entered correctly, the Security select screen will be displayed (see Figure 11), with the currently selected security level highlighted.



Figure 11 - The Security select screen

4. To change the security level, use the  and  soft keys to highlight the required level, then press the  soft key. The Security level screen will then be displayed again, showing the newly selected security level.
5. Press the  soft key twice to display the Menu screen again.

Changing passwords

- + If you change a password, ensure that you record the new password somewhere safe. Otherwise, if you cannot recall the new password, you will have to contact Servomex or your local Servomex agent for assistance.

Use the following procedure to change the supervisor and operator passwords:

















1. With the Measurement screen displayed, press the  soft key to display the Menu screen, use the  and  soft keys to highlight the "Settings" menu option, then press the  soft key. The Settings screen will then be displayed (see Figure 6).
2. Use the  and  soft keys to highlight the "Password" menu option, then press the  soft key. The Edit supervisor password screen will then be displayed with the supervisor password shown, as shown in Figure 12.









Figure 12 - The Edit supervisor password screen

3. To change the supervisor password, press the  soft key, then enter the new password: use the editing method described in Section 4.10.
4. When you enter the last digit, the  soft key changes to the  soft key. Press the  soft key to enter the new supervisor password value.
5. To change the operator password, press the  soft key to display the edit operator password screen, press the  soft key, then enter the new password: use the editing method described in Section 4.10.
6. When you enter the last digit, the  soft key changes to the  soft key. Press the  soft key to enter the new operator password value.
7. Press the  soft key to display the Settings screen again.

5.3.2 Setting the clock





Use the following procedure to set the date and time:

1. Press the  soft key to display the Menu screen, use the  and  soft keys to highlight the "Settings" menu option, then press the  soft key. The Settings screen will then be displayed.
2. Use the  and  soft keys to highlight the "Clock" menu option, then press the  soft key. The Clock (time) screen will then be displayed, as shown in Figure 13.

+ Time is always shown
+ in 24-hour format.







Figure 13 - The Clock (time) screen

3. Press the  soft key, then edit the displayed time as described in Section 4.10. When you change the last digit, the  soft key changes to the  soft key. Press the  soft key to show the Clock (time) screen again.
4. Press the  soft key to show the Clock (date) screen, as shown in Figure 14.

+ You can change this
+ format from day/month/
+ year to month/day/year:
+ refer to Section 5.3.3.



Figure 14 - The Clock (date) screen

5. To change the date, press the  soft key, then edit the displayed date as described in Section 4.10. When you change the last digit, the  soft key changes to the  soft key. Press the  soft key to show the Clock (date) screen again.
6. Press the  soft key twice to display the Menu screen.

+ The date format can be set to your regional preference ('day/month/year' or 'month/day/year' format): refer to Section 5.3.3.

+ On a Multi Purpose without an optional rechargeable battery: once set, date and time will remain set until approximately 1 week after the Multi Purpose has been disconnected from the electrical supply. If the Multi Purpose is left connected to the electrical supply, date and time will remain set indefinitely, even if the Multi Purpose is switched off.

5.3.3 Changing regional settings

You can configure the following Multi Purpose regional settings so that the information shown on the various screens is better suited to your local conventions:

Setting	Options available
Language	Various languages are supported.
Date format	Day/Month/Year * or Month/Day/Year.
Decimal format	Use of "." (full stop) or "," (comma) as the decimal point.

* Default option.

To change the regional settings:













1. With the Settings screen displayed, use the  and  soft keys to highlight the "Regional" menu option, then press the  soft key. The first Regional settings option screen will then be displayed, as shown in Figure 15.





Figure 15 - The Regional settings (language) option screen

2. This screen shows the first regional option (Language). If necessary, press the  soft key, use the  and  soft keys to highlight the required display language, then press the  soft key.
3. If required, for each of the other two selectable options (date format and decimal format):
 - Use the  and  soft keys to select the corresponding option screen.
 - Press the  soft key.
 - Use the  and  soft keys to highlight the required option, then press the  soft key.

5.3.4 Selecting power save mode (Multi Purpose with optional rechargeable battery)

If your Multi Purpose has the optional rechargeable battery, you can select the 'power save' mode of operation, to conserve battery power. When power save mode is selected, the Multi Purpose will automatically switch off after 30 minutes has elapsed during which no key has been pressed.

To select/deselect power save mode:

1. With the Settings screen displayed, use the  and  soft keys to highlight the "Power save" menu option, then press the  soft key. The Power save option screen will then be displayed, as shown in Figure 16.

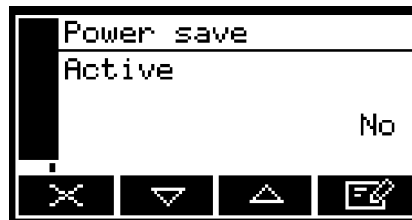



Figure 16 - The Power save option screen



2. "No" or "Yes" on this screen identifies whether power save is selected or not. If necessary, press the  soft key to select the alternative setting, then press the  soft key.
- + Power save mode is automatically disabled when the Multi Purpose is connected (through the power supply unit) to the electrical supply.

5.3.5 Selecting pump operation (Multi Purpose HF or standard Multi Purpose with optional internal sample pump)

If your Multi Purpose has an internal sample pump fitted, you must select how you want to operate the pump before you start to make sample measurements. The pump can be operated using one of two methods:

Method	Pump operation
Manual	When you press the Pump key on the front of the Multi Purpose (see Figure 1), the sample pump will start. You must then press the key again, to stop the pump.
Timed	When you press the Pump key on the front of the Multi Purpose (see Figure 1), the sample pump will start, operate for a preset time, and then stop. If you select this mode, you must also specify the time for which the pump should operate.

To select the required method of sample pump operation:

1. With the Settings screen displayed, use the  and  soft keys to highlight the "Set up" menu option, then press the  soft key. The Set up screen will then be displayed, as shown in Figure 17.

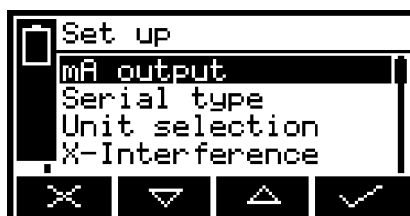

Figure 17 - The Set up screen









2. Use the  and  soft keys to highlight the "Pump" menu option, then press the  soft key. The Pump mode screen will then be displayed, as shown in Figure 18 (which shows manual pump operation selected).



Figure 18 - The Pump mode screen

3. If you want to change the method of sample pump operation, press the  soft key, use the  and  soft keys to highlight the alternative menu option, then press the  soft key.

If you have selected Timed pump operation, you must then continue at Step 4 below to set the pump operation time.

4. With the Pump mode screen displayed (as described above), and with "Timed" operation selected, press the  or  soft key so that the Pump duration screen is displayed, as shown in Figure 19.

This screen shows the currently selected duration (that is, the time for which the pump will operate when you press the Pump key).



Figure 19 - The Pump duration screen

5. If you want to change the duration, press the  soft key then edit the displayed duration as described in Section 4.10.

+ Pump duration can be set in the range 1 to 999 seconds.

6 GENERAL OPERATION

	<p style="text-align: center;">WARNING</p> <p>This gas analyser may be used with sample and/or calibration gases that could present a toxic hazard, as the local gas concentrations may exceed short- or long-term exposure limits (and very high dilution rates may be needed to safely vent the gases used). You must therefore ensure that you are fully aware of the potential hazards of the gases used, carry out your own risk assessment and create suitable safe working practices based on these hazards, and ensure that these working practices are complied with whenever the analyser is used. If in doubt about the potential hazards of the gases to be used with the analyser, seek expert advice from appropriate specialists/safety consultants.</p>
---	--

<p style="text-align: center;">CAUTION</p> <p>Sample and calibration gases must be as specified in Sections 2.2 and 2.3. If your sample or calibration gas pressures and/or flow rates are above those specified in Sections 2.2 and 2.3, you must regulate the gases externally, before they enter the Multi Purpose.</p>
--

6.1 Calibrating the Multi Purpose

- + The pressure of your calibration gas supply must be the same as the pressure of the gases to be sampled. If the pressures are different, sample gas measurements may not be accurate.
- + For a Multi Purpose HF, the calibration gas flow rate should be as close as possible to the flow rate of sample gases.
- + If you do not allow calibration gas to pass through the Multi Purpose for 3 to 5 minutes before you start the calibration procedure, the measurement system in the Multi Purpose may not be fully purged of other residual gases, and the calibration may not be accurate.
- + Do not knock or move the Multi Purpose during calibration. If you do, the calibration measurements may be affected.
- + For a standard Multi Purpose with a sample pump, the following calibration procedure assumes that you have selected manual pump operation. If you have selected timed pump operation, you must ensure that the pump operation time is set correctly to allow calibration gas to pass through the Multi Purpose for sufficient time: refer to Section 5.3.5 for more information.
- + For a Multi Purpose HF, no calibration 'T' piece is supplied and no such T' piece should be used. You must not switch on the Multi Purpose HF sample pump at any time during the calibration procedure.
- + The calibration procedure in this section is for a Multi Purpose without an optional flowmeter or sample conditioning panel. If your Multi Purpose has one of these options, refer to the appropriate Appendix A6 or Appendix A7 for additional information on calibration.

You must calibrate the Multi Purpose as part of the initial set-up (see Section 5.3), and whenever the Multi Purpose has been moved to a different environment. We also recommend that you calibrate the Multi Purpose at each power up, to avoid measurement errors due to changes in ambient conditions. Calibrate the Multi Purpose as follows:

1. If you have a Multi Purpose HF or a standard Multi Purpose without a sample pump:
 - Connect your calibration gas supply to the sample gas inlet on the front of the Multi Purpose (see Figure 1). Ensure that the calibration gas pressure is as specified in Section 2.3.
 - Allow the calibration gas to pass through the Multi Purpose for 3 to 5 minutes, then continue at Step 3.
2. If you have a standard Multi Purpose with a sample pump:
 - Connect the branch on the calibration 'T' piece to the sample gas inlet on the front of the Multi Purpose (see Figure 1)
 - Connect a suitable vent pipeline to one end of the calibration 'T' piece; alternatively, if it is safe to do so, leave the end of the 'T' piece open to vent to the local atmosphere.
 - Connect your calibration gas supply to the other end of the 'T' piece.
 - Switch on the sample pump (see Section 5.3.5), allow the calibration gas to pass through the Multi Purpose for 3 to 5 minutes, then continue at Step 3.
3. Press the  soft key on the Measurement screen (or select the "Calibrate" option from the Menu screen) to display the Calibrate screen (see Figure 20).

+ On a 2-measurement Multi Purpose, this screen will show one Lo and one Hi calibration for each of the two gases.

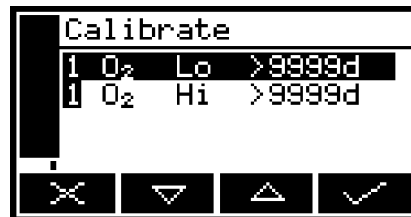





Figure 20 - The Calibrate screen

Note that the "9999d" field of the screen shown in Figure 20 will identify the period of time that has elapsed since the last calibration, and can be in any of the following forms:

- 9999d specifying days
- 9999h specifying hours
- 9999m specifying minutes
- Any combination of these.

4. Use the  and  soft keys to select the required calibration, that is:
 - 'Lo' (low calibration gas: for example, nitrogen for an oxygen sensor).
 - 'Hi' (high calibration gas: for example, oxygen for an oxygen sensor).

5. Press the  soft key. The Calibrate target value screen will then be shown (see Figure 21), identifying the target value and the current reading.

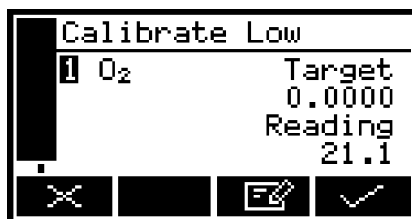



Figure 21 - The Calibrate target value screen

6. If the target value is not that for the calibration gas which you are using, change the target value to the required value: use the edit method in Section 4.10.
 - + Refer to Sections 2.2 and 2.3 for the required pressures, flow rates (if applicable) and concentrations of the calibration gases.
7. When the current reading is stable, press the  soft key. The Multi Purpose will then carry out the specified calibration.
8. If you have a standard Multi Purpose with a sample pump, switch the pump off (if necessary: see Section 5.3.5).
9. Disconnect the calibration gas supply from the sample gas inlet or the calibration 'T' piece.
10. Repeat Steps 1 to 9 of this section for the second calibration for the specific sample gas.
11. If your Multi Purpose is configured to provide two sample gas measurements, repeat Steps 1 to 10 of this section to carry out the 'Lo' and 'Hi' calibrations for the second sample gas.
12. On a Multi Purpose with the optional sample pump: disconnect your vent pipeline (if fitted) from the calibration 'T' piece, then disconnect the 'T' piece from the sample gas inlet.
13. Press the  soft key to display the Measurement screen again.

6.2 Taking sample readings

- + Depending on how you have configured the measurement alarms, and on how you connect the sample gases to the Multi Purpose, a measurement alarm may occur when you change sample gases as described below.
 - + Unless your sample gases are known to be dry, you must connect the drying tube (supplied with the Multi Purpose) to the sample gas inlet on the Multi Purpose, and then connect your sample gas supply to the drying tube.
 - + The procedure in this section is for a Multi Purpose without an optional flowmeter, sample conditioning panel or gas probe. If your Multi Purpose has one or more of these options, refer to the appropriate Appendix A6, Appendix A7 or Appendix A8 for additional information on sampling.
1. If necessary, calibrate the Multi Purpose: see Section 6.1.
 2. Ensure that the Measurement screen is displayed: see Section 4.
 3. Use the quick-connect fitting supplied to connect the sample gas supply to the sample gas inlet on the front of the Multi Purpose (see Figure 1).
 4. If your Multi Purpose has a sample pump, start the sample pump: see Section 5.3.5.
 5. Wait until the measurement shown on the screen has stabilised, then take note of the reading.
 6. If your Multi Purpose has a sample pump and you have selected manual pump operation, stop the sample pump: see Section 5.3.5.
 7. Turn off the sample gas supply, or disconnect it from the sample gas inlet on the front of the Multi Purpose.

Repeat Steps 3 to 7 as necessary, for different gas samples to be measured.

6.3 Correcting oxygen measurement for different background gases

- + If you are measuring oxygen in a background of nitrogen or air, you do not need to correct the measurements.

6.3.1 Overview of measurement errors

For an oxygen sensor, the composition of any typical background gas in the gas sample will have a negligible effect on the Multi Purpose measurement. For a Multi Purpose which has been 'Lo' calibrated with nitrogen and 'Hi' calibrated with oxygen, the cross-interference errors (that is, oxygen measurement errors) in gases which contain 100% of a specific background gas will be as shown below:

Background gas	Error	Background gas	Error
Argon	-0.22%	Krypton	-0.49%
Carbon dioxide	-0.26%	Neon	-0.15%
Halothane	-1.93%	Nitrous oxide	-0.20%
Helium	-0.29%	Xenon	-0.92%





Note that the error is directly proportional to the concentration of the background gas in the sample being measured, and in most cases can be ignored.



If you cannot ignore the error, you can use the procedure in Section 6.3.2 to enter a compensation to correct for the error.

6.3.2 Entering a cross-interference compensation

- + You can only apply cross-interference compensation to oxygen sample measurements. You must not apply cross-interference compensation to IR gas measurements.
- + Cross-interference compensation is disabled during calibration, and is not applied to the values shown in Figure 21. All other outputs (that is, serial or milliAmp outputs) remain compensated.

Use the following procedure to enter a compensation to correct for an oxygen measurement error:

1. Press the  soft key to display the Menu screen, use the  and  soft keys to highlight the "Set up" menu option, then press the  soft key. The Set up screen will then be displayed (see Figure 17).

2. Use the  and  soft keys to highlight the "X-Interference" menu option, then press the  soft key:
 - If your Multi Purpose is configured for a single sample measurement, the X-Interference offset screen is then displayed, as shown in Figure 23. Continue at Step 4.
 - If your Multi Purpose is configured for 2 sample measurements, the X-Interference select screen will then be displayed, as shown in Figure 22. Continue at Step 3 below.

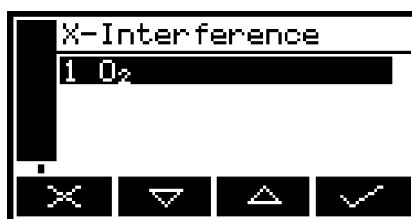





Figure 22 - The X-Interference select screen

3. With the X-Interference select screen displayed, use the  and  soft keys to highlight the required measurement, then press the  soft key.

The X-Interference offset screen is then displayed, as shown in Figure 23. Continue at Step 4 below.

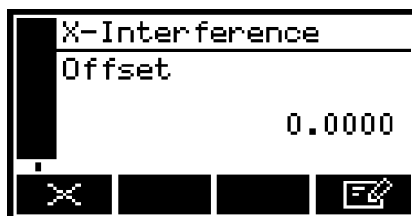



Figure 23 - The X-Interference offset screen

4. The offset value shown on the X-Interference offset screen is the correction which will be applied to oxygen sample measurements before they are displayed (or output).

If you want to change the offset value, press the  soft key, then edit the displayed offset as described in Section 4.10.











6.4 Selecting display units

You can change the measurement units shown on the display (and output during data logging, and so on). The following display units are supported:

Units	Meaning
%	volume %
ppm	parts per million
vpm	volume parts per million
mg/m ³	mg m ⁻³ (milligrams per normal cubic metre)
mol/mol	mols per mol (or moles per mole)
% LEL	volume % of the Lower Explosive Limit

- + When you select display units other than the measurement default units, you must also enter the units conversion factor: refer to Appendix A5 to determine the units conversion factor for your specific application.
- + If you select the "off" option on the units selection screen, the display units revert to the measurement default units as supplied.
- + Converting from one measurement unit to a different display measurement unit may reduce the resolution of the displayed measurements.

Use the following procedure to select the displayed units, and to change the units conversion factor:

1. Press the  soft key to display the Menu screen, use the  and  soft keys to highlight the "Set up" menu option, then press the  soft key. The Set up screen will then be displayed (see Figure 17).
2. Use the  and  soft keys to highlight the "Unit selection" menu option, then press the  soft key:
 - If you have a 1-measurement Multi Purpose, the Currently selected units screen will be displayed, as shown in Figure 24.
 - If you have a 2-measurement Multi Purpose, use the  and  soft keys to highlight the required gas sensor, then press the  soft key: the Currently selected units screen (for the selected gas) will then be displayed, as shown in Figure 24.

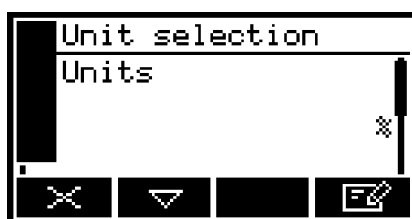





Figure 24 - The Currently selected units screen

3. If you want to view or change the units conversion factor, continue at Step 6.
4. If you want to change the currently displayed units, press the  soft key: the Units selection screen will then be displayed, as shown in Figure 25.
5. Use the  and  soft keys to highlight the required units, then press the  soft key to select the units. The Currently selected units screen will then be displayed again, with the newly selected units shown.

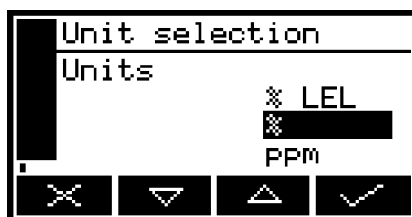



Figure 25 - The Units selection screen

6. With the Currently selected units screen (Figure 24) shown, press the  soft key. The Units conversion factor screen will then be displayed, as shown in Figure 26.

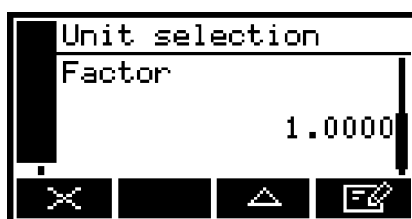



Figure 26 - The Units conversion factor screen

7. If you want to change the units conversion factor, press the  soft key, then edit the displayed offset as described in Section 4.10.
8. If you have a 2-measurement Multi Purpose, if necessary repeat Steps 1 to 7 of the above procedure to change the display units for the second gas measurement.

6.5 Configuring the measurement alarms

6.5.1 Alarm modes and levels

Two separate measurement alarms are available for each sample gas measurement for which the Multi Purpose is configured, and you can configure each alarm to operate in one of three modes:

Alarm mode	Operation
None	The alarm is not used (that is, an alarm condition will not be activated under any circumstances).
Low alarm	An alarm condition will be activated when a sample measurement is lower than the preset alarm level.
High alarm	An alarm condition will be activated when a sample measurement is higher than the preset alarm level.

While a measurement alarm condition is activated:

- An 'alarm' icon is shown on the measurement screen (see Section 4.2). The number ("1" or "2") in the icon will identify the alarm which has been triggered.
- If the audible measurement alarm is enabled (see Section 6.5.5), the audible alarm goes on.
- The alarm LED on the front of the Multi Purpose (see Figure 1) flashes on and off.
- You can view the details of the activated alarm: see Section 6.5.8.

6.5.2 Latching/non-latching alarms

You can configure each of the two measurement alarms to be either latching or not latching:

Alarm setting	Meaning
Latching	Once the alarm condition has been activated, the alarm condition remains activated (even if subsequent sample measurements would not trigger the alarm) until the alarm is manually unlatched: see Section 6.5.7.
Not latching	Once the alarm condition has been activated, the alarm condition remains activated only until a subsequent sample measurement which would not trigger the alarm is made. The alarm condition is then deactivated.

6.5.3 Hysteresis levels

The hysteresis level associated with a measurement alarm determines when an alarm condition (once activated) is deactivated, and this depends on the alarm mode, as follows:

Alarm mode	Effect of hysteresis
Low alarm	Once the low alarm condition has been activated, the alarm condition will not be deactivated until a sample measurement is above (alarm level + hysteresis level).
High alarm	Once the high alarm condition has been activated, the alarm condition will not be deactivated until a sample measurement is below (alarm level - hysteresis level).

For example:

- If a 'low' alarm has an alarm level of 18% and a hysteresis level of 1%, the alarm will be activated when a sample measurement is < 18%, and the alarm will not be deactivated until a sample measurement is > 19%.
- If a 'high' alarm has an alarm level of 20% and a hysteresis level of 2%, the alarm will be activated when a sample measurement is > 20%, and the alarm will not be deactivated until a sample measurement is < 18%.

6.5.4 Setting the measurement alarm levels and modes

- + Ensure that the measurement alarm and hysteresis levels are not too close to the expected sample measurements. (If they are, minor - and acceptable - variations in your sample gas concentrations will result in spurious alarms.)
- + If you configure one measurement alarm as 'low' and configure the other alarm as 'high', ensure that the 'high' alarm and hysteresis levels are higher than the 'low' alarm and hysteresis levels. (If you do not, the Multi Purpose can be permanently in an alarm condition, until you correct the levels.)

Before you start to take sample readings, you must ensure that the measurement alarms are correctly configured for your sample gases.









1. On the Measurement screen, press the  soft key. The Alarm option screen will then be displayed, as shown in Figure 27.
2. Highlight the "Set up" menu option, then press the  soft key. The Alarm set up screen will then be displayed, as shown in Figure 28.
3. Use the  and  soft keys to highlight the required alarm, then press the  soft key. The Alarm mode screen will then be displayed, as shown in Figure 29.
4. If the alarm mode is not the required mode, press the  soft key, use the  and  soft keys to select the required mode (none, low or high), then press the  soft key.



Figure 27 - The Alarm option screen

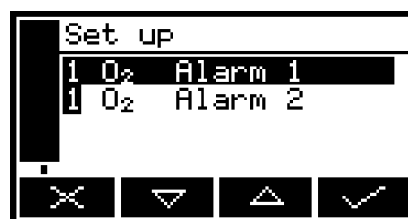



Figure 28 - The Alarm set up screen



Figure 29 - The Alarm mode screen

5. On the Alarm mode screen, use the  and  soft keys to highlight each of the following alarm options, and select the required option (using the method in Step 4 above) or enter the appropriate levels (using the method described in Section 4.10):
 - Latching
 - Level
 - Hysteresis.

6.5.5 Enabling/disabling the audible measurement alarm







- + The audible measurement alarm options are "Yes" (for enable) and "No" (for disable).
1. With the Alarms option screen displayed (see Section 6.5.4), use the  and  soft keys to highlight the "Audible alarm" option, then press the  soft key.
 2. If the displayed alarm setting is not the required setting, press the  soft key. The Audible alarm option screen will then be displayed: see Figure 30.





Figure 30 - The Audible alarm option screen

3. Use the  and  soft keys to select the required option ("Yes" or "No"), then press the  soft key.

6.5.6 Silencing (muting) the audible measurement alarm

- + The audible alarm will only go on when a measurement is made which triggers a measurement alarm condition **and** the audible measurement alarm has been enabled (see Section 6.5.5).

When the audible alarm is on because of a measurement alarm condition, you can temporarily silence (mute) the audible alarm, as follows:



1. On the Measurement screen, press the  soft key; the Alarm option screen (Figure 27) will then be displayed.
2. With the "Mute" option highlighted, press the  soft key. The audible alarm will then go off and the Measurement screen will be displayed again.

- + Once silenced, the audible alarm will go on again:
 - If a new measurement alarm condition is activated.
 - If the measurement alarm condition which caused the audible alarm to go on is deactivated and is then re-activated.



You will then need to silence the audible measurement alarm again.

6.5.7 Unlatching measurement alarms

When necessary, use the following procedure to unlatch any 'latched' measurement alarm(s) (see Section 6.5.2):

1. On the Measurement screen, press the  soft key; the Alarm option screen (Figure 27) will then be displayed.
2. With the "Unlatch" option highlighted, press the  soft key. All latched alarms will then be unlatched and the Measurement screen will be displayed again.

6.5.8 Viewing the measurement alarm status

1. On the Measurement screen, press the  soft key; the Alarm option screen (see Figure 27) will then be displayed.
2. With the "View" option highlighted, press the  soft key. The Alarm status screen will then be displayed (see Figure 31).

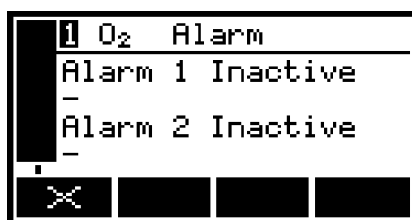



Figure 31 - The Alarm status screen

- + If your Multi Purpose is configured to provide 2 sample gas measurements, a vertical scroll bar will be shown at the right of the screen, and a  soft key will be shown. Press the  soft key to view the measurement alarm status for the second sample measurement.

In the Alarm status screen shown in Figure 31, both measurement alarms are shown as "Inactive"; that is, either the mode of each alarm is set to 'none', or no alarm condition currently exists.

If a measurement alarm condition exists when you view this screen, the screen will show:

- The alarm number ("1" or "2").
- The sample reading which triggered the alarm condition.
- The alarm mode (where "<" indicates a low alarm and ">" indicates a high alarm).
- The alarm level.

6.6 Configuring and using the milliAmp outputs (optional feature)

6.6.1 Overview

The Multi Purpose can be supplied with a milliAmp output for each sample gas measurement for which the Multi Purpose is configured. Each milliAmp output provides a constantly updated output (from the connector(s) on the rear of the Multi Purpose, see Figure 2), in which the current represents the value of gas sample measurements.

The Multi Purpose allows you to specify two separate output configurations for each milliAmp output: Range 1 and Range 2. The Range with which a measurement is currently associated is shown on the Measurement screen (see Figure 3):

I is shown if Range 1 is selected.

II is shown if Range 2 is selected.

Each milliAmp output provides one of the following selectable output current ranges, for gas sample measurements:

- 0 to 20 mA, where 0 mA represents a sample measurement of 0 (zero) and 20 mA represents a user selected highest sample measurement (the span).
- 4 to 20 mA, where 4 mA represents a sample measurement of 0 (zero) and 20 mA represents a user selected highest sample measurement (the span).

In addition to the above, you can specify how the milliAmp output will operate during calibration, during a fault condition, and during under-range conditions.

Details of the output parameters for the milliAmp outputs are given in Section 6.6.2. Set up, configure, check, calibrate and use the milliAmp outputs as described in Sections 6.6.3 to 6.6.6.

6.6.2 Introduction to the milliAmp output parameters

The milliAmp output parameters that you must set up are as follows:

Parameter	Values/options
Range 1 high level	The Range 1 highest sample measurement (span) *.
Range 2 high level	The Range 2 highest sample measurement (span) *.
During calibration	The selected option determines how the milliAmp output will operate during calibration: <ul style="list-style-type: none"> Freeze As soon as the calibration screen is displayed, the milliAmp output will 'freeze' at its last output value. The output will only be updated to reflect subsequent measurements when calibration has been completed. Follow The milliAmp output value will reflect the measurement value, even during calibration.
Jam condition	The selected option determines how the milliAmp output will operate during a fault condition: <ul style="list-style-type: none"> High The output value will be held at 21.5 mA. Low The output value will be held at 0 mA. None The output values will continue to be derived from the sample gas measurements, even though these output values may be erroneous.
mA output range	0-20 mA or 4-20 mA *, configurable as follows: <ul style="list-style-type: none"> 0-20% to 0-100% O₂ (standard oxygen sensor) 0-1% to 0-100% O₂ (industrial or high accuracy oxygen sensor) 0-10% to 0-100% of Full Scale Range † (infrared sensor)
Underrange	Any value below 4 mA #







* See Section 6.6.1.

† See Section 2.8.

Only available if the 4-20 mA output range is selected; this sets the lowest output current during normal operation, and allows negative gas concentrations to be monitored through the milliAmp outputs. For example, with an under-range setting of 3.8 mA, the milliAmp outputs can be less than 4 mA (which indicates a zero gas concentration), down to a minimum of 3.8 mA, where an output between 3.8 mA and 4 mA indicates a negative gas concentration.

6.6.3 Set up the milliAmp output parameters

Use the following procedure to set up the milliAmp output parameters:

1. Press the  soft key to display the Menu screen, use the  and  soft keys to highlight the "Set up" menu option, then press the  soft key. The Set up screen will then be displayed (see Figure 17).
2. Use the  and  soft keys to highlight the "mA output" menu option, then press the  soft key: the mA configuration screen is then shown (see Figure 32).

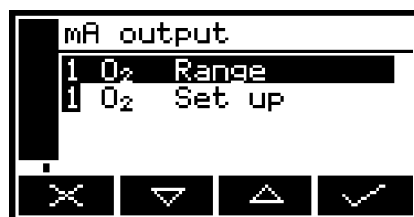

Figure 32 - The mA configuration screen









3. Use the  and  soft keys to highlight the required "Set up" option, then press the  soft key: the corresponding mA output high level screen will then be shown: see Figure 33.













Figure 33 - The mA output high level screen

4. If necessary, change the displayed parameter using the edit method described in Section 4.10.
 5. For each of the other milliAmp parameters (see Section 6.6.2):
 - Use the  and  soft keys to select the corresponding parameter screen.
 - Change the parameter as necessary: press the  soft key then use the  and  soft keys to select the required option, or edit the data as described in Section 4.10.
- + You cannot enter a high level (span) value higher than the maximum measurement that the corresponding gas sensor can determine (refer to Sections 2.5 to 2.8).

6.6.4 Select the Range associated with a measurement

Use the following procedure at any time during sampling to change the Range (see Section 6.6.1) associated with a gas measurement:

1. Press the  soft key to display the Menu screen, use the  and  soft keys to highlight the "Set up" menu option, then press the  soft key. The Set up screen will then be displayed (see Figure 17).
2. Use the  and  soft keys to highlight the "mA output" menu option, then press the  soft key: the mA configuration screen is then shown (see Figure 32).
3. Use the  and  soft keys to highlight the required gas Range option, then press the  soft key: the mA range screen will then be displayed, as shown in Figure 34.

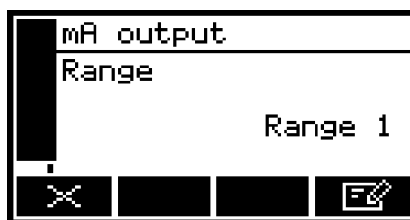











Figure 34 - The mA range screen

4. To change the selected Range:
 - Press the  soft key, then use the  and  soft keys to highlight the alternative Range option (Range 1 or Range 2).

Press the  soft key: the mA Range screen will then be displayed again, with the new Range shown.

6.6.5 Calibrate a milliAmp output

Use the following procedure to calibrate a milliAmp output:

1. Press the  soft key to display the Menu screen, use the  and  soft keys to highlight the "Service" menu option, then press the  soft key. The mA output service screen will then be displayed: see Figure 36.
2. Select the required 'Calibrate' option, then press the  soft key. The mA output calibrate screen will then be displayed, as shown in Figure 35.

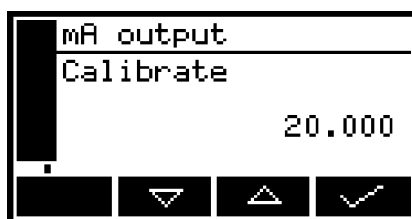









Figure 35 - The mA output calibrate screen

3. As soon as the mA output calibrate screen is shown, the nominal milliAmp output value is set to 20 mA:
 - Use your equipment (connected to the corresponding milliAmp connector on the rear of the Multi Purpose) to monitor the actual output value.
 - Use the  and  soft keys to increase or decrease the actual output value until your equipment indicates 20 mA output.
 4. When the milliAmp output has been correctly calibrated, press the  soft key: the mA output service screen (Figure 36) will then be displayed again.
- + The actual milliAmp output value is controlled from the mA output calibrate screen as long as the screen is displayed. As soon as the mA service screen is displayed, the milliAmp output value will be updated to reflect the corresponding gas measurement.

6.6.6 Check a milliAmp output

If required, use the following procedure at any time to perform a check on a milliAmp output:

1. Press the  soft key to display the Menu screen, use the  and  soft keys to highlight the "Service" menu option, then press the  soft key. The mA output service screen will then be displayed: see Figure 36.

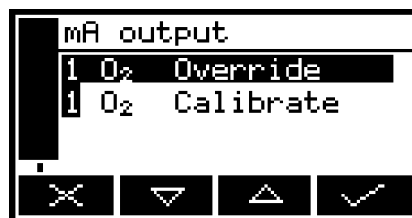



Figure 36 - The mA output service screen

2. Select the required 'Override' option, then press the  soft key. The mA output override screen will then be displayed, as shown in Figure 37.

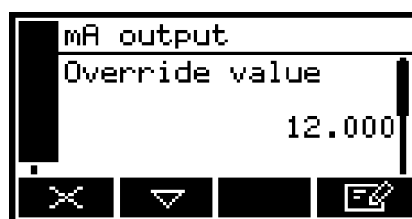







Figure 37 - The mA output override screen

3. Edit the displayed override value as described in Section 4.10.
4. Press the  soft key: an acceptance screen showing "No" will then be displayed.
5. To apply the override, press the  soft key: an 'Override' screen will then be shown. Use the  and  soft keys to highlight the "Yes" option, then press the  soft key.

The milliAmp output will now be set to the override value you have selected. Use your equipment (connected to the corresponding milliAmp connector on the rear of the Multi Purpose) to check that the output is correct.

6. If required, repeat Steps 3 to 5 above to check for other milliAmp output values, or press the  soft key to display the mA output service screen again.

+ The milliAmp output freezes at the override value as long as the 'Override' screen is displayed. As soon as another screen is displayed, the milliAmp output value will be updated to reflect the corresponding gas measurement.



6.7 Data logging, serial outputs and printed outputs

6.7.1 Selecting data logging/serial output/printed outputs

You can configure the Multi Purpose to provide data logging, to provide serial outputs, or to provide printed outputs to an optional Servomex supplied printer:

- When serial output is selected, data is continuously output to your PC (or other device) connected to the serial output port on the rear of the Multi Purpose.
- When data logging is selected, measurement information is stored in Multi Purpose memory (see Section 6.7.3). You must manually initiate output of the stored data log to a connected device, as described in Section 6.7.6.
- When printer (printed output) is selected, you must manually initiate the printing of a sample measurement report (to the optional Servomex supplied printer), as described in Section 6.7.9.

Use the following procedure to select the required option:

1. With the Menu screen displayed, use the  and  soft keys to highlight the "Set up" menu option, then press the  soft key. The Serial type screen will then be displayed, as shown in Figure 38.

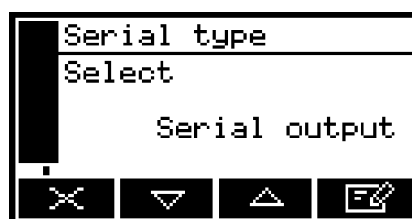



Figure 38 - The Serial type screen

2. If the option shown on the Serial type screen is not the required option, press the  soft key; the Serial type select screen will then be displayed (see Figure 39).

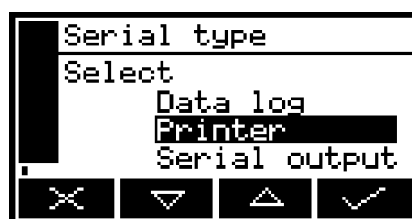





Figure 39 - The Serial type select screen

3. Use the  and  soft keys to select the required option, then press the  soft key.
4. Press the  soft key to display the Menu screen.

6.7.2 Configuring the serial output parameters

- + The serial output parameters apply to both the data logging and serial output options (see Section 6.7.1).

If you have selected data logging or serial outputs, you must configure the Multi Purpose serial output parameters to suit the requirements of the PC (or other device) which you have connected to the serial output port on the rear of the Multi Purpose. The output parameters which you can configure are listed below:

Parameter	Valid settings
Period *	0 to 999 seconds.
Baud rate	2400, 4800, 9600, 19200 and 38400 are all supported.
Stop bits	1 or 2.
Data bits	7 or 8.
Parity	None, odd parity, or even parity.

* Time between updates: not applicable to data logging.

To configure the parameters:



1. From the Settings screen, use the  and  soft keys to highlight the "Serial output" menu option, then press the  soft key. The first parameter screen will then be displayed: if you have selected serial outputs, the RS232 period screen will be shown (see Figure 40); if you have selected data logging, the RS232 baud rate screen will be shown (see Figure 41).



Figure 40 - The RS232 period screen

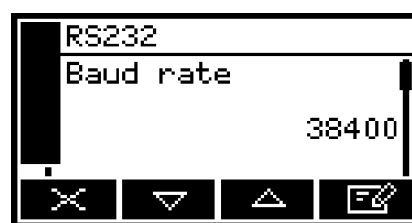





Figure 41 - The RS232 baud rate screen

2. If necessary, change the displayed parameter using the edit method described in Section 4.10.
3. For each of the other configurable parameters (see above):
 - Use the  and  soft keys to select the corresponding parameter screen.
 - Change the parameter as necessary: use the  and  soft keys to highlight the required option, or edit the data as described in Section 4.10.

6.7.3 Introduction to data logging

The Multi Purpose allows you to maintain a data log of sample measurements made, within the Multi Purpose memory. The data log consists of one or more 'batches' of measurements, and a total of 200 measurements can be stored.

Each sample measurement entered in the log has:

- an associated batch number
- a sequence number of the sample measurement within the batch
- the date and time that the measurement was made
- an alarm indication (if the measurement caused a measurement alarm to be raised)
- a fault indication (if a fault existed at the time of the measurement).

You must manually transfer measurements into the data log, specify when a new batch is to start within the data log, and clear the data log when necessary.

At any time, you can view the currently stored data log on the Multi Purpose display, or you can output it to a device (such as a PC) connected to the Multi Purpose serial output port.

- + The Multi Purpose cannot be configured to automatically log data over specified periods of time. If you require such a facility, we recommend that you select serial outputs (instead of data logging) and connect the serial output to a PC or a commercially available data logger.

6.7.4 Entering measurement data into the data log

When you want to enter the sample measurement(s) from the Measurement screen into the data log:

1. Press the  soft key. When you press the soft key, the current sample measurement at the time of the key press is 'captured' (stored in internal memory), and the Data logging screen will then be displayed (see Figure 42).

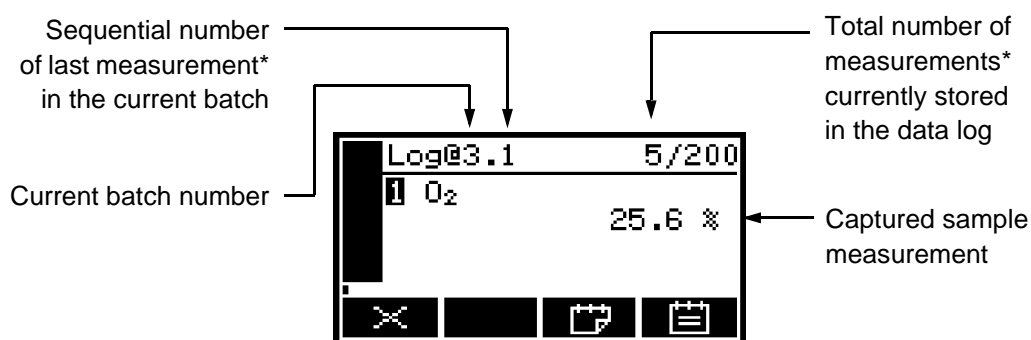

* Or set(s) of measurements, on a Multi Purpose configured for 2 sample gas measurements.

Figure 42 - The Data logging screen

2. To store the measurement data in the data log, press the  soft key.



A Log taken screen (Figure 43) is then displayed for a few seconds to verify that the measurement data has been stored in the data log, then the Measurement screen is shown again





Figure 43 - The Log taken screen

- + To return to the Measurement screen without storing the captured sample measurement data in the data log, press the  soft key when the data logging screen is displayed.

6.7.5 Starting a new data log batch

1. With the Measurement screen displayed, press the  soft key. The Data logging screen will then be displayed (see Figure 42).
2. Press the  soft key. A new batch will then be started within the data log (and the batch sequence number of the next measurement will be reset to "1").

- + No new measurement data is entered into the data log when you press the  soft key. To enter data into the new batch, you must press the  soft key again, or use the procedure given in Section 6.7.4.

6.7.6 Outputting the data log

















1. With the Menu screen displayed, use the  and  soft keys to highlight the "Data log" option, then press the  soft key. The Data log options screen will then be displayed, as shown in Figure 44.



Figure 44 - The Data log options screen

2. Use the  and  soft keys to highlight the "Output log" option, then press the  soft key. The output of the data log will be initiated, and the Measurement screen will then be shown again.
- + The data log will only be output if you have correctly configured the serial output parameters as described in Section 6.7.2.

6.7.7 Viewing the data log

1. With the Menu screen displayed, use the  and  soft keys to highlight the "Data log" option, then press the  soft key. The Data log options screen will then be displayed, as shown in Figure 44.
2. Use the  and  soft keys to highlight the "View log" option, then press the  soft key. The View log (batch) screen is then displayed, alternating with the View log (date) screen: see Figures 45 and 46.
3. Use the  and  soft keys to scroll through all of the measurements stored in the data log.
4. When you have finished viewing the data log, press the  soft key or the  soft key to display the Data log options screen again.

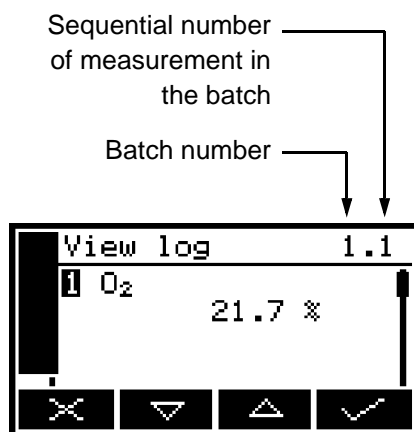

Figure 45 - The View log (batch) screen

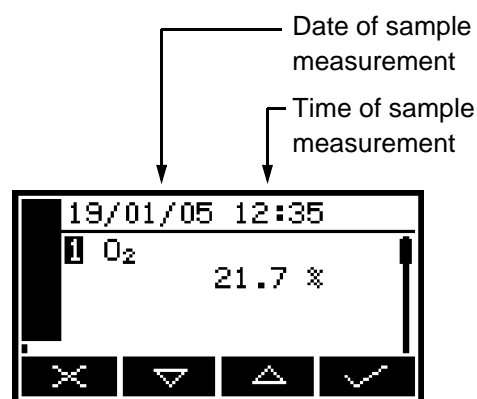











Figure 46 - The View log (date) screen

6.7.8 Clearing the data log

- + Ensure that you have viewed the data log (see Section 6.7.7) or have output the data log if required (see Section 6.7.6) before you clear the log.
 - + You cannot clear batches or individual measurements from the data log.
1. With the Menu screen displayed, use the  and  soft keys to highlight the "Data log" option, then press the  soft key. The Data log options screen will then be displayed, as shown in Figure 44.
 2. Use the  and  soft keys to highlight the "Clear log" option, then press the  soft key. The screen will then show an "Are you sure?" message:
 - Press the  soft key to clear the data log. The Data log options screen is then displayed again.
 - Press the  soft key to display the Data log options screen again without clearing the data log.

6.7.9 Printing a sample measurement report

If you have selected printed outputs (see Section 6.7.1), you must manually initiate the printing of each sample measurement report.

Press the  soft key when you want to print a report. Refer to Appendix A3 for the format of the printed sample measurement report.

6.8 Adjusting the display

At any time, you can adjust the screen display to suit the ambient light conditions, as described in Sections 6.8.1 and 6.8.2.

6.8.1 Adjusting the backlight timer

When the Multi Purpose is first switched on, the backlight goes on to illuminate the screen. If no soft key is pressed, the backlight will remain on for the preset 'backlight time', and will then go off. The timer associated with the backlight time is restarted whenever a soft key is pressed (that is, the backlight remains on for the backlight time after the last soft key press). To adjust the backlight time:



1. On the Settings screen, highlight the "Backlight" option, then press the  soft key. The Backlight timer screen will then be displayed, as shown in Figure 47.
2. Change the backlight time (Duration) setting as required, then press the  soft key.



Figure 47 - The Backlight timer screen

- + The backlight time (Duration) can be set between 0 and 999 seconds. Set the backlight time (Duration) to 0 seconds to leave the backlight permanently switched on.

6.8.2 Adjusting the contrast







1. On the Settings screen, highlight the "Contrast" option, then press the  soft key. The Contrast screen will then be displayed, as shown in Figure 48.



Figure 48 - The Contrast screen



2. Use the  and  soft keys to increase or decrease the contrast to the required level, then press the  soft key.
 - + Hold the  or  soft key pressed in to adjust the contrast quickly.

6.9 Switching off the Multi Purpose after use

When you have finished using the Multi Purpose:

1. Switch off the Multi Purpose: press and hold the Power On/Off key for approximately 2 seconds, then release the key when the audible alarm goes on.
2. If you will not use the Multi Purpose for several days:
 - Disconnect any tubes from the sample gas outlet (on the front or the rear of the Multi Purpose: see Figures 1 and 2) and from the bypass gas outlet (if fitted) on the rear of the Multi Purpose (see Figure 2).
 - Fit protective plastic caps to the sample gas outlet (on the front or the rear of the Multi Purpose: see Figures 1 and 2), to the bypass gas outlet (if fitted) on the rear of the Multi Purpose (see Figure 2), and to the sample gas inlet on the front of the Multi Purpose (see Figure 1).
3. If required, disconnect the Multi Purpose from the electrical supply.
 - + If your Multi Purpose has the optional rechargeable battery, we recommend that you allow the battery to fully recharge before you disconnect the Multi Purpose from the electrical supply.
 - + If your Multi Purpose has the optional rechargeable battery, you can leave the Multi Purpose connected to the electrical supply. This will not affect the service life of the battery.

7 ROUTINE MAINTENANCE

	<p>WARNING</p> <p>Sample and calibration gases may be toxic or asphyxiant. Never inspect the inlet filter, remove the side panels from the Multi Purpose, or service or repair the Multi Purpose while such gases are still connected to it.</p>
	<p>WARNING</p> <p>Sample and calibration gases may be toxic or asphyxiant and may build up within the Multi Purpose during use. Always inspect the inlet filter, service the Multi Purpose, or remove the side panels from the Multi Purpose in a well-ventilated environment, so that such gases (if present) do not present a hazard.</p>
	<p>WARNING</p> <p>Sample and calibration gases may be toxic or asphyxiant. If you suspect there is a gross leak or internal pipework damage in the Multi Purpose, leave the Multi Purpose in a well-ventilated environment for at least 8 hours before servicing or repair.</p>

7.1 Cleaning the Multi Purpose

Regularly use a damp (but not wet) cloth to wipe clean the outer surfaces of the Multi Purpose, to prevent the entry of dust or other particulates into the gas sample inlet or the interior of the Multi Purpose.

7.2 Inspecting the inlet filter element

- + The filter element is made of borosilicate glass, and the filter retainer cap 'O' ring is made from Viton[®] (fluoroelastomer).
- + New filter elements and filter retainer cap 'O' rings are available as spares: see Section 10.

If you only use the Multi Purpose on applications which use clean, dry cylinder gases, you will only need to inspect the inlet filter element every 3 months. On other applications, we recommend that you inspect the inlet filter element more frequently.

1. Ensure that the Multi Purpose is switched off.
2. Unscrew and remove the filter retainer cap (see Figure 1).

3. Inspect the condition of the white filter element (fitted to the spigot on the rear of the filter retainer cap). If the filter element is wet or dirty:
 - Remove the used filter element from the filter retainer cap, then dispose of the element.
 - Push a new filter element onto the spigot on the inner side of the filter retainer cap.
4. Inspect the 'O' ring on the inner side of the filter retainer cap. If the 'O' ring is twisted or damaged:
 - Remove the 'O' ring, then dispose of it.
 - Fit a new 'O' ring to the inner side the filter retainer cap.
5. Ensure that the 'O' ring is correctly located in the recess in the inner side of the filter retainer cap, then refit and tighten the filter retainer cap.

CAUTION

Do not operate the Multi Purpose with the filter element removed. If you do, particulates in the sample gas will seriously damage the Multi Purpose.

7.3 Regenerate/replace the drying agent

A Multi Purpose without a Sample Conditioning Panel is supplied with a drying tube which can be either of two types:

- A flexible drying tube, containing an indicating silica gel drying agent.
- A screw-top drying tube, containing non-indicating Drierite[®] drying agent.

If your Multi Purpose is supplied with a flexible drying tube, you must regenerate or replace the drying agent when it has changed colour from orange to green: if required, use the procedure given in Section A7.8 to regenerate the drying agent. After regeneration or replacement of the drying agent, take care when you refit the barbed connections on the drying tube, to ensure that they are securely fitted.

If your Multi Purpose is supplied with a screw-top drying tube, we recommend that you regenerate or replace the drying agent after approximately 2 hours of use sampling wet gases. If required, use the procedure given in Section A7.8 to regenerate the drying agent.

When you want to replace the drying agent, note that both types of drying agent are available as spares (see Section A7.9) or from various suppliers. The recommended granule sizes for the drying agents are:

- 0.5-1.0 mm granule size for the indicating silica gel
- 8 mesh (or smaller) granule size for the Drierite[®] (calcium sulphate) drying agent.

7.4 Use of the Multi Purpose for carbon monoxide measurements

	<p style="text-align: center;">WARNING</p> <p>If you sample carbon monoxide, the quantity of gas sampled by the Multi Purpose may be above the short term exposure limit for carbon monoxide, and so the sample should be considered to be toxic. You must regularly leak-test the Multi Purpose and associated equipment. If leaks are found, do not continue to use the analyser or associated equipment until the leaks have been sealed.</p>
---	---

<p style="text-align: center;">CAUTION</p> <p>When you carry out a leak test, do not exceed a maximum pressure of 34.5 kPa gauge (5 psig, 0.35 bar gauge) and do not introduce a sudden change of pressure into the Multi Purpose. If you do, you can damage it.</p>
--

If you use the Multi Purpose for carbon monoxide sample measurements, you must regularly leak-test the Multi Purpose and the associated sample/vent lines or system.

We recommend that you leak-test the Multi Purpose at least once every 6 months:

- If there are leaks within the Multi Purpose, it must be returned to Servomex for repair. Do not continue to use the Multi Purpose.
- You must seal any leaks in your sample/vent lines or system.

When you leak-test, ensure that you do not exceed the maximum pressure, and do not increase the pressure in the Multi Purpose too quickly (see the caution above): we recommend that you allow at least 30 seconds to fully pressurise the Multi Purpose to the maximum pressure.

7.5 Preventative maintenance

To minimise unscheduled Multi Purpose downtime, to ensure the proper operation of the Multi Purpose, and to comply with the guidelines of applicable regulatory bodies, we recommend that you utilise the Servomex annual preventative maintenance program for your Multi Purpose.

The preventative maintenance program consists of a yearly inspection of the Multi Purpose at a Servomex service facility, and repair of any faults, to ensure that the Multi Purpose meets its original factory specification. Once inspection and repair are complete, the Multi Purpose is returned, together with a dated service certificate.

Note that:

- Loan analysers are available for your use while your Multi Purpose is undergoing preventative maintenance.
- You will always be informed in advance if any repairs or new parts are required for your Multi Purpose.

Contact Servomex or your local Servomex agent to arrange for a preventative maintenance contract.

8 FAULT FINDING

8.1 Introduction to faults and fault messages

When the Multi Purpose internal self-test facilities detect a fault:

- The audible alarm emits a single short tone.
- The amber fault LED (see Figure 1) goes on.
- A fault icon is shown on the measurement screen (see Figure 3).
- An appropriate fault message is stored.

You can view the current faults as described in Section 8.2. The fault messages which can be shown - together with the recommended actions you should take - are listed (in alphabetical order) in the table below:

Fault message	Recommended actions
Battery fault	(This message will only be shown on a Multi Purpose which has the optional rechargeable battery fitted.) Disconnect the power supply unit plug from the electrical supply outlet, wait 30 seconds, then reconnect the plug to the electrical supply outlet. If the fault persists, contact Servomex or your local Servomex agent for assistance.
Calibration fault	Recalibrate (both low and high) as described in Section 6.1. If the fault persists, contact Servomex or your local Servomex agent for assistance.
Charging Timeout	(This message will only be shown on a Multi Purpose which has the optional rechargeable battery fitted.) Check that the ambient temperature is in the correct range for recharging (see Section 2.4), and try to recharge the battery again. If the fault persists, contact Servomex or your local Servomex agent for assistance.
Code fault	Contact Servomex or your local Servomex agent for assistance.
Communication fail	Turn the Multi Purpose off, and then turn it on again. If the fault message is then displayed again, contact Servomex or your local Servomex agent for assistance.
Database fault	Contact Servomex or your local Servomex agent for assistance.

Fault messages (Sheet 1 of 3)



Fault message	Recommended actions
Date/Time invalid	<p>This usually occurs because a Multi Purpose without the optional rechargeable battery has been left disconnected from the electrical supply for more than a week. On a Multi Purpose with the optional rechargeable battery, this may occur when the battery is empty (fully discharged).</p> <p>Connect the Multi Purpose to the electrical supply, then set the date/time as described in Section 5.3.2. If the fault persists, contact Servomex or your local Servomex agent for assistance.</p>
Fatal fault	<p>Contact Servomex or your local Servomex agent for assistance.</p>
mA fault	<p>(This fault message will only be shown on a Multi Purpose which has optional milliAmp outputs.)</p> <p>Ensure that the electrical cabling connected to the Multi Purpose is not open circuit.</p> <p>Turn the Multi Purpose off, and then turn it on again. If the fault persists, contact Servomex or your local Servomex agent for assistance.</p>
mA not detected	<p>(This fault message will only be shown on a Multi Purpose which has optional milliAmp outputs.)</p> <p>Contact Servomex or your local Servomex agent for assistance.</p>
mA reset	<p>(This fault message will only be shown on a Multi Purpose which has optional milliAmp outputs.)</p> <p>Contact Servomex or your local Servomex agent for assistance.</p>
Power Config fault	<p>Contact Servomex or your local Servomex agent for assistance.</p>

Fault messages (Sheet 2 of 3)

Fault message	Recommended actions
Pump fault	<p>(This fault message will only be shown on a Multi Purpose with an internal sample pump.)</p> <p>Check that the sample gas inlet (see Figure 1) and the sample gas outlet and bypass gas outlet (see Figure 2) are not blocked or obstructed, and that any pipes or tubes connected to the inlet and outlets are not blocked or obstructed.</p> <p>After checking the inlet, outlets and pipes/tubes, restart the sample pump (see Section 5.3.5). If the fault persists, contact Servomex or your local Servomex agent for assistance.</p>
Static RAM fault	<p>Turn the Multi Purpose off, and then turn it on again. If the fault message is then displayed again, contact Servomex or your local Servomex agent for assistance.</p>
Transducer error	<p>Ensure that you are using the Multi Purpose in the specified operating conditions (refer to Section 2). If the fault persists, contact Servomex or your local Servomex agent for assistance.</p>
Tx incorrect type	<p>Contact Servomex or your local Servomex agent for assistance.</p>
Tx Maintenance	<p>Check that the sample gas concentration is not higher than the transducer Full Scale Range.</p> <p>Recalibrate (both low and high) as described in Section 6.1. If this does not clear the fault, turn the Multi Purpose off, and then turn it on again. If the fault message is then displayed again, contact Servomex or your local Servomex agent for assistance.</p>
Tx not detected	<p>Contact Servomex or your local Servomex agent for assistance.</p>

Fault messages (Sheet 3 of 3)

8.2 Viewing fault messages

If you want to view details of faults currently detected by the Multi Purpose, use the  and  soft keys to highlight the "Faults" option on the Menu screen, then press the  soft key. The Fault status screen will then be displayed as shown in Figure 49.

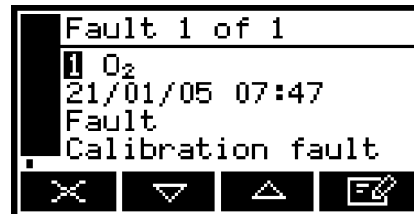



Figure 49 - The Fault status screen

If there is more than one currently detected fault, this will be indicated by the screen heading and by the scroll bar at the right of the screen. If required you can use the  and  soft keys to scroll through and view all of the current faults.

Each fault status screen shows:

- Date and time of fault
- Fault indicator
- Fault message.

Refer to Section 8.1 for the recommended actions associated with the displayed fault messages.

8.3 General fault finding

For general Multi Purpose fault finding, refer to the table on the following pages.

If you have read through the table and still cannot rectify a fault, or cannot identify the cause of a fault, contact Servomex or your local Servomex agent for assistance.

Fault symptom	Recommended actions
The Fault LED is on.	<p>Check any current fault messages (see Section 8.2), and carry out the recommended actions (see Section 8.1).</p> <p>If there are no applicable fault messages stored, or if you cannot rectify the fault after you have carried out the recommended actions:</p> <ul style="list-style-type: none"> • Switch off the Multi Purpose, then switch it on again. • If the fault persists, contact Servomex or your local Servomex agent for assistance.
The software health indicator is not moving on the display.	Carry out the recommended actions for the "The Fault LED is on" symptom above.
" - - - - " is displayed instead of a sample measurement (or appears in the data log).	<p>This indicates a possible measurement error, or a communications error between a transducer and the Multi Purpose controller.</p> <p>Check that the Multi Purpose is not being knocked, moved, or subjected to high levels of vibration during sample measurements.</p> <p>If the Multi Purpose is not being knocked, moved or subjected to vibration and the fault persists, contact Servomex or your local Servomex agent for assistance.</p>
" ↑↑↑↑↑↑ " is displayed instead of a sample measurement (or appears in the data log).	<p>This indicates that the sample gas measurement is above the upper measurement limit of the Multi Purpose.</p> <p>If this is displayed or appears during calibration, check that the calibration gas is as specified in Section 2.3 and recalibrate the Multi Purpose.</p> <p>If this is displayed or appears during sample measurement, check that the sample gas target range is within the specification of the Multi Purpose (see Section 2.2).</p>

General fault finding (Sheet 1 of 5)

Fault symptom	Recommended actions
<p>" ↓↓↓↓↓↓↓↓ " is displayed instead of a sample measurement (or appears in the data log).</p>	<p>This indicates that the sample gas measurement is below the lower measurement limit of the Multi Purpose.</p> <p>If this is displayed or appears during calibration, check that the calibration gas is as specified in Section 2.3 and recalibrate the Multi Purpose.</p> <p>If this is displayed or appears during sample measurement, check that the sample gas target range is within the specification of the Multi Purpose (see Section 2.2).</p>
<p>Multi Purpose response is slow.</p>	<p>Check that the sample gas inlet is not blocked, and that the sample gas supply to the Multi Purpose is not restricted.</p> <p>Check that the sample gas outlet and bypass gas outlet are not blocked, and that any tubes or pipes connected to the outlets are not restricted.</p> <p>Inspect the inlet filter element and replace it if necessary: refer to Section 7.2.</p> <p>Check that the sample gas supply pressure is correct: refer to Section 2.2.</p> <p>Check that the Multi Purpose is being used in the correct ambient conditions: refer to Section 2.4.</p>
<p>Multi Purpose measurements are not as expected.</p>	<p>Check that the correct display units have been selected, and that the units conversion factor has been correctly entered (see Section 6.4).</p> <p>Check that any cross-interference offsets that you have entered are correct (see Section 6.3.2).</p>

General fault finding (Sheet 2 of 5)

Fault symptom	Recommended actions
Multi Purpose measurements are unstable.	<p>Check that the sample gas supply pressure is correct: refer to Section 2.2.</p> <p>Check that the Multi Purpose is not being subjected to high levels of vibration.</p> <p>Check that the sample gas inlet is not blocked, and that the sample gas supply to the Multi Purpose is not restricted.</p> <p>Check that the sample gas outlet and bypass gas outlet (if fitted) are not blocked, and that any tubes or pipes connected to the outlets are not restricted.</p> <p>Inspect the filter element and replace it if necessary: refer to Section 7.2.</p>
The Multi Purpose will not calibrate.	<p>Check that the correct low and high calibration gases are being used: refer to Section 2.3.</p> <p>Check that the sample gas inlet is not blocked, and that the sample gas supply to the Multi Purpose is not restricted.</p> <p>Check that the sample gas outlet and bypass gas outlet (if fitted) are not blocked. On a standard Multi Purpose with an internal sample pump, check that the calibration 'T' piece is not blocked. Check that any tubes or pipes connected to the outlets (or to the calibration 'T' piece) are not restricted.</p> <p>Inspect the filter element and replace it if necessary: refer to Section 7.2.</p>

General fault finding (Sheet 3 of 5)

Fault symptom	Recommended actions
The Multi Purpose will not switch on.	<p>If the green light on the power supply unit is on:</p> <ul style="list-style-type: none"> • Check that the power supply is correctly connected to the Multi Purpose: see Section 5.1. • If the power supply is already correctly connected to the Multi Purpose, contact Servomex or your local Servomex agent for assistance. <p>If the green light on the power supply unit is off:</p> <ul style="list-style-type: none"> • Check that the power supply unit is correctly connected to your electrical supply outlet, and that your external electrical supply is correct: see Section 2.1. • Check the fuse in the power supply unit plug. If the fuse has failed, replace it with a new fuse of the correct rating. • If the power supply unit is correctly connected to your electrical supply outlet and your external electrical supply is correct, the power supply unit may have failed: contact Servomex or your local Servomex agent for assistance. <p>If you have a Multi Purpose with the optional rechargeable battery, and the power supply unit is not connected to the electrical supply and to the Multi Purpose, the battery may be flat: connect the power supply unit and recharge the battery (refer to Section 5.2).</p>
The Multi Purpose display is blank or is too dark.	<p>Check that the ambient temperature is within the valid Multi Purpose operating temperature range: refer to Section 2.4.</p> <p>Check that the display contrast adjustment has been correctly set (refer to Section 6.8.2), and has not been altered.</p>
The measurement alarms are activating more often than expected.	<p>Check that the Multi Purpose is not being knocked, moved, or subjected to high levels of vibration during sample measurements.</p> <p>Check that the alarm modes, alarm levels and hysteresis levels have been correctly set: refer to Section 6.5.4.</p>

General fault finding (Sheet 4 of 5)

Fault symptom	Recommended actions
The Multi Purpose does not communicate correctly through the serial output connector.	<p>Check that the update rate has been correctly set.</p> <p>Check whether data logging has been enabled, and disable data logging if necessary (refer to Section 6.7.1). (If data logging is enabled, continuous serial data outputs will be disabled.)</p> <p>Check that the Multi Purpose serial output parameters have been correctly set for the system to which you have connected the serial outputs (refer to Section 6.7.2).</p> <p>Check that the external device is correctly connected to the Multi Purpose serial port: refer to Appendix A4.</p> <p>If you have connected the serial outputs to a PC (Personal Computer), check that the correct serial port is selected on the PC. (Note that you may have to restart the PC for serial port changes to take effect.)</p>
A milliAmp output is at 0 or 21.5 A.	If you have configured the milliAmp output to jam high or jam low, check whether a fault condition exists (see Section 6.6.2). Otherwise, contact Servomex or your local Servomex agent for assistance.
A milliAmp output is not as expected.	<p>Ensure that the electrical cabling connected to the Multi Purpose is not open circuit.</p> <p>Check that the milliAmp output is calibrated correctly (see Section 6.6.5).</p> <p>Check that you have selected the correct Range (see Section 6.6.1).</p>

General fault finding (Sheet 5 of 5)

9 STORAGE AND DISPOSAL

9.1 Storage

Refit any protective plastic covers (see Section 3) and place the Multi Purpose and any associated equipment in its original packaging before storage. Alternatively, seal it inside a waterproof plastic bag, sack, or storage box.

Store the Multi Purpose and any associated equipment in a clean, dry area. Do not subject it to excessively hot, cold, or humid conditions: see Section 2.4.

- + If your Multi Purpose has an optional rechargeable battery, recharge the battery every 2 months: see Section 5.2.2.

9.2 Disposal

Dispose of the Multi Purpose, the power supply unit and any other associated equipment safely, and in accordance with all of your local and national safety and environmental requirements.

- + The Multi Purpose is not suitable for disposal in municipal waste streams (such as landfill sites, domestic recycling centres and so on). Refer to Appendix A10 for disposal requirements in accordance with the WEEE Directive within the EC.
- + If you send the Multi Purpose to Servomex or your local Servomex agent for disposal, the Multi Purpose must be accompanied by a correctly completed decontamination certificate.

10 SPARES

The standard spares available for the Multi Purpose are shown below. You can order these spares from Servomex or your agent.

Spare	Part Number
Inlet filter element (pack of 5)	00570982
Filter retainer cap 'O' ring	2323-7029
Inlet/outlet quick-connect fitting	202517
Power supply unit	202578
Thermal printer paper (pack of 5 rolls)	203022
Internal sample pump (standard Multi Purpose)	05200930
Internal sample pump (Multi Purpose HF)	05200948
Rechargeable battery pack	05200931

- + We recommend that you maintain a stock of inlet filter elements and a filter retainer cap 'O' ring, so you can replace them when necessary: see Section 7.2.

APPENDIX

A1 DATA LOG OUTPUT FORMATS

The data log is output in the form of an identifier line, followed by a number of log lines, one line for each entry stored in the data log.

The identifier line is in the form: "Servomex <serial number> ; <gas>", where <serial number> is the Multi Purpose serial number as shown on the Information screen (see Figure 7) and <gas> is as specified below.

Each log line consists of a number of elements, separated from each other by the delimiter string " ; " (space, semicolon, space), in the following format:

```
<log id> ; <date> ; <time> ; <gas> ; <measurement> ; <units> ; <alarm status> ; <fault status>
      [ ; <gas> ; <measurement> ; <units> ; <alarm status> ; <fault status>]
```

where:

<log id>	Is in the form "X.Y", where "X" is a digit (or digits) specifying the batch number and "Y" is a digit (or digits) specifying the number of the measurement within the batch.
<date>	Is the date on which the data log entry was made.
<time>	Is the time at which the data log entry was made.
<gas>	Specifies the sample gas measured.
<measurement>	Is the actual sample measurement as displayed on the measurement screen.
<units>	Is the measurement units, as displayed on the measurement screen.
<alarm status>	Is either blank (not output), or "Alarm" if a measurement alarm condition existed when the log entry was made.
<fault status>	Is either blank (not output), or "Fault" if a fault condition existed when the log entry was made.
"[" and "]"	Elements between these bracket symbols are only output when the Multi Purpose is configured for two sample measurements. The bracket symbols themselves do not appear in the output.

A typical extract from a 1-measurement Multi Purpose data log output is shown below:

```
Servomex 05123A1/45678 ; O2
1.1 ; 19/01/05 ; 14:57:04 ; O2 ; 14.8 ; % ; Alarm ;
1.2 ; 19/01/05 ; 14:57:09 ; O2 ; 14.8 ; % ; Alarm ;
1.3 ; 19/01/05 ; 14:57:16 ; O2 ; 14.8 ; % ; Alarm ; Fault
2.1 ; 19/01/05 ; 14:57:36 ; O2 ; 14.8 ; % ; Alarm ;
2.2 ; 19/01/05 ; 14:57:42 ; O2 ; 14.8 ; % ; Alarm ;
2.3 ; 19/01/05 ; 14:57:58 ; O2 ; 14.8 ; % ; Alarm ; Fault
3.1 ; 19/01/05 ; 14:58:13 ; O2 ; 14.8 ; % ; Alarm ;
3.2 ; 19/01/05 ; 14:58:46 ; O2 ; 20.5 ; % ; ;
3.3 ; 19/01/05 ; 14:58:51 ; O2 ; 20.5 ; % ; ;
3.4 ; 19/01/05 ; 14:58:55 ; O2 ; 20.5 ; % ; ; Fault
4.1 ; 19/01/05 ; 14:59:03 ; O2 ; 20.5 ; % ; ; Fault
4.2 ; 19/01/05 ; 14:59:08 ; O2 ; 20.5 ; % ; ;
```

APPENDIX

A2 SERIAL OUTPUT FORMATS

The serial output consists of a number of measurement lines, one line for each update.

Each measurement line consists of a number of elements, separated from each other by the delimiter string " ; " (space, semicolon, space), in the following format:

```
<date> ; <time> ; <gas> ; <measurement> ; <units>[ ; <gas> ; <measurement> ; <units>]
```

where:

<date>	Is the date on which the data log entry was made.
<time>	Is the time at which the data log entry was made.
<gas>	Specifies the sample gas measured.
<measurement>	Is an actual sample measurement, as displayed on the measurement screen.
<units>	Is the measurement units, as displayed on the measurement screen.
"[" and "]"	Elements between these bracket symbols are only output when the Multi Purpose is configured for two sample measurements. The bracket symbols themselves do not appear in the output.

An extract from a typical serial output for a 1-measurement Multi Purpose is shown below:

```
19/01/05 ; 14:50:25 ; O2 ; 20.3 ; %  
19/01/05 ; 14:50:35 ; O2 ; 20.3 ; %  
19/01/05 ; 14:50:45 ; O2 ; 20.3 ; %  
19/01/05 ; 14:50:55 ; O2 ; 20.3 ; %  
19/01/05 ; 14:51:05 ; O2 ; 20.3 ; %
```

+ Alarms and fault information are not provided in the serial outputs.

APPENDIX

A3 PRINTER OUTPUT FORMATS

If you have selected printed outputs (see Section 6.7.1), each time you press the  soft key, a single sample measurement report is printed (on the Servomex supplied printer). The format of this report is as shown below:

Date:	<date>
Time:	<time>
I.D.:	<serial number>
Batch:	_____
Product:	_____
Measurement:	
1 <gas>	XXXX <units> <alarm>
2 <gas>	XXXX <units> <alarm>
Signature	_____

where:

<date>	Is the date on which the report was printed, in the currently selected format (see Section 5.3.2).
<time>	Is the time at which the report was printed, in the format hh:mm:ss (hours:minutes:seconds).
<serial number>	Is the serial number of the Multi Purpose.
1 <gas>	Specifies transducer 1 and the sample gas measured.
2 <gas>	Specifies transducer 2 and the sample gas measured.
+	This complete line is shown blank on the printer output for a 1-measurement Multi Purpose.
XXXX	Is the sample measurement.
<units>	Is the measurement units, as displayed on the measurement screen.

<alarm>	Specifies the alarm or other status: <ul data-bbox="576 331 1378 730" style="list-style-type: none"><li data-bbox="576 331 1378 398">• "Pass" indicates that alarms have been configured, and that the sample measurement has not triggered an alarm.<li data-bbox="576 425 1378 492">• "FAIL" indicates that alarms have been configured, and that the sample measurement has triggered an alarm.<li data-bbox="576 519 1378 553">• "FAULT" indicates that a transducer fault is present.<li data-bbox="576 580 1378 730">• "RECALIB" indicates that the transducer needs to be recalibrated. (This will be shown when the sample measurement is >100% or < 0% and no alarms have been configured.) If no alarms have been configured (and no transducer or recalibration fault is present), <alarm> will be blank.
Batch and Product	Are fields which you can complete (by hand) to identify, for example, a specific batch, and a specific product within that batch.
Signature	Is a field which can be used for the signature of the person who printed the report.

- + Refer to your company procedures for the correct usage of the Batch, Product and Signature fields of printed sample measurement reports.
- + Refer to the printer manual for additional information (for example, on how to replace the printer roll).

APPENDIX

A4 RS232 CONNECTION DETAILS

	WARNING Ensure that the electrical installation of any equipment connected to the Multi Purpose conforms with all applicable local and national electrical safety requirements.
---	---

A4.1 Overview

The serial port on the rear of the Multi Purpose (see Figure 2) is an RS232 ± 5.5 V 9-way 'D' type connector.

The pins on the connector are used as shown in Figure A1 below:

Pin(s)	Use
1	Not used
2	Rx (to Multi Purpose)
3	Tx (from Multi Purpose)
4	Not used
5	0 V
6, 7, 8, 9	Not used

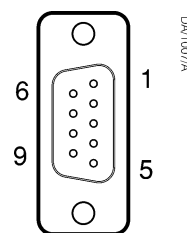

Figure A1 - RS232 connection pin details

A4.2 Connecting the Multi Purpose to a PC

The Multi Purpose can be directly connected to the 9-way 'D' type serial port (usually designated "COM1" or "COM2") on your PC. To comply with EMC immunity standards, we recommend that you use the serial output cable supplied. If you do not use the cable supplied, use a compatible 9-way 'D Null Modem' cable (with a recommended maximum length of 3 m), with female-to-female connectors.

If your PC only has USB serial ports, use a commercially available 9-way 'D' type serial to USB converter to connect the Multi Purpose to one of the serial ports.

A4.3 Capturing data using Windows® and Hyper Terminal™

If you use one of the Windows operating systems, HyperTerminal is probably already installed on your PC. For detailed instructions on the installation and use of HyperTerminal, refer to the help files on your PC, or to the documentation supplied with your PC. The following information is provided as a summary only, for quick reference.

1. Install HyperTerminal (if not already installed).
2. Start HyperTerminal. You can usually do this by clicking on the Start button, then by clicking on: Programs, Accessories, Communications, HyperTerminal.
3. Enter a suitable name and select a 'connect' icon for the connection.
 - + You can drag the icon onto your desktop for quick access to HyperTerminal.
4. Identify the "COM" port that you have used to connect the Multi Purpose to the PC.
5. Set the port settings to be consistent with the Multi Purpose serial output parameters (see Section 6.7.2). The recommended settings are as follows:

Parameter	Recommended setting
Baud rate	38400
Data bits	8
Parity	None
Stop bits	1
Flow control	None *

* This is not an option on the Multi Purpose.

6. Click on the 'connect' icon to initiate the connection:
 - If you have configured the Multi Purpose to provide serial output (see Section 6.7.1), data will then be displayed on the PC.
 - If you have configured the Multi Purpose for data logging, data will only be sent to the PC when you output the data log (see Section 6.7.6).

Data output from the Multi Purpose can be saved (as a text file) using the 'capture text' command in HyperTerminal. You can then import this text directly into applications such as Excel®.

APPENDIX

A5 DISPLAY UNIT CONVERSION FACTORS

When you select display units as described in Section 6.4, you must ensure that you also enter the correct units conversion factor, as shown in the table below:

To convert from *	to †	use the units conversion factor	applicable gas(es)
%	ppm	10000	any
ppm	%	0.0001	any
ppm	vpm	1	any
ppm	mg/m ³	1.2492	CO
"	"	1.9631	CO ₂
"	"	1.4277	O ₂
%	mg/m ³	12492	CO
"	"	19631	CO ₂
"	"	14277	O ₂
ppm	%LEL	0.0008	CO
%	%LEL	8	CO
%	mol/mol	0.01	any
ppm	mol/mol	#	#

* Measurement default units.

† Selected display units

This conversion is not supported.

+ To return to the measurement default units, select the "off" units selection option and set the units conversion factor to "1": see Section 6.4.

APPENDIX

A6 OPTIONAL FLOWMETERS

A6.1 Overview

Two optional flowmeters are available for the Multi Purpose, as follows:

- The unvalved flowmeter, for use with a standard Multi Purpose without an internal sample pump. This flowmeter shows the flow rate of sample gas or calibration gas into the Multi Purpose.
- The flowmeter with a flow control valve, for use with a Multi Purpose HF or a standard Multi Purpose with an internal sample pump. This flowmeter shows (and allows you to control) the flow rate of sample gas or calibration gas into the Multi Purpose.

A6.2 Specification

Flowmeter indicated flow rate range

Standard Multi Purpose without sample pump	1 to 10 l min ⁻¹ *
Standard Multi Purpose with sample pump	100 to 1000 cm ³ min ⁻¹ †
Multi Purpose HF	200 to 2500 cm ³ min ⁻¹ #

* Equivalent to a flow rate range of 0.035 to 0.35 ft³ min⁻¹.

† Equivalent to a flow rate range of 100 to 1000 ml min⁻¹ (0.0035 to 0.035 ft³ min⁻¹).

Equivalent to a flow rate range of 0.2 to 2.5 l min⁻¹ (0.007 to 0.087 ft³ min⁻¹).

A6.3 Preparing the Multi Purpose with a flowmeter

If you have ordered the flowmeter option, the flowmeter will be supplied fitted to the side of the Multi Purpose, as shown in Figure A2.

Before you use the Multi Purpose, ensure that the inlet pipe (2) is correctly fitted between the flowmeter outlet and the sample gas inlet on the front of the Multi Purpose. If the pipe is not already fitted:

1. Remove the protective plastic cover from the flowmeter outlet.
2. Remove the protective plastic cover from the sample gas inlet on the front of the Multi Purpose (Figure 1, item 8).
3. Fit the inlet pipe supplied between the flowmeter outlet and the sample gas inlet on the front of the Multi Purpose.

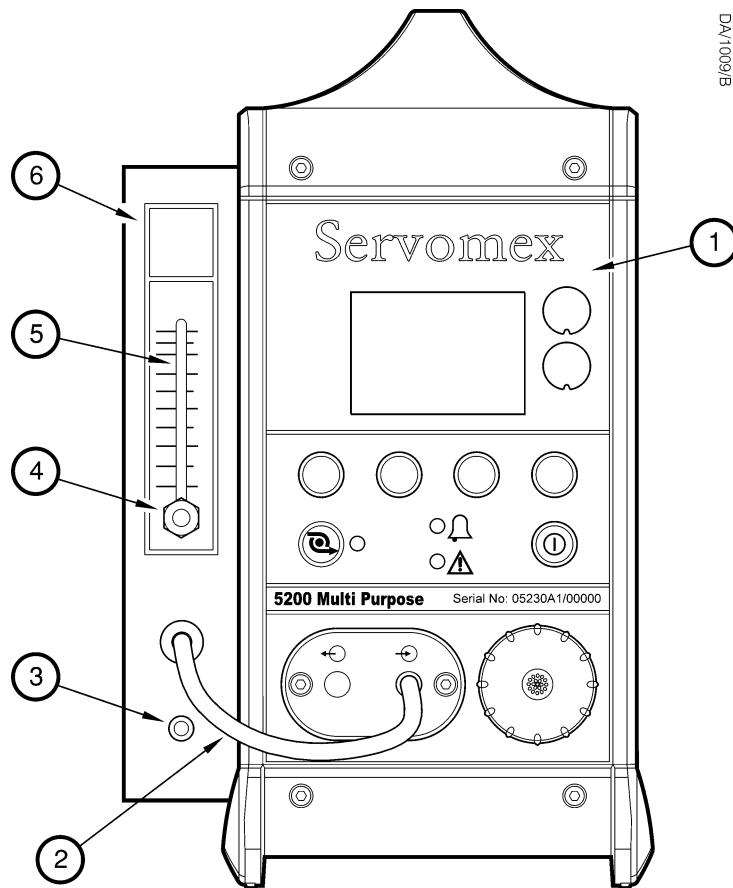

Key	Description	Key	Description
1.	Multi Purpose	4.	Flow control valve †
2.	Inlet pipe *	5.	Flow indicator
3.	Sample gas inlet	6.	Flowmeter assembly

* Fitted between the flowmeter outlet and the Multi Purpose inlet.

† Only fitted to a valved flowmeter for use with a Multi Purpose HF or a standard Multi Purpose with an internal sample pump.

Figure A2 - Multi Purpose with a flowmeter

A6.4 Using the Multi Purpose with a flowmeter

Operate the Multi Purpose with the flowmeter as described in Sections 4 to 6 of this manual, but with the exceptions noted below.

A6.5 Multi Purpose HF and standard Multi Purpose with a sample pump

- + The flow rate of your calibration gas supply must be the same as the flow rate of the gases to be sampled. If the flow rates are different, sample gas measurements may not be accurate.

Calibrate the Multi Purpose as described in Section 6.1, but:

- Connect the calibration gas supply to the sample gas inlet on the flowmeter (Figure A2, item 3), not to the Multi Purpose.
- Use the flow control valve (Figure A2, item 4) to adjust the flow of calibration gas into the Multi Purpose to the required flow rate.

Take sample readings as described in Section 6.2, but:

- Connect the sample gas supply to the sample gas inlet on the flowmeter (Figure A2, item 3), not to the Multi Purpose.
- Use the flow control valve (Figure A2, item 4) to adjust the flow of sample gas into the Multi Purpose to the required flow rate.

A6.6 Standard Multi Purpose without a sample pump

Calibrate the Multi Purpose as described in Section 6.1, but connect the branch on the calibration 'T' piece to the sample gas inlet on the flowmeter (Figure A2, item 3), not to the Multi Purpose.

Take sample readings as described in Section 6.2, but connect the sample gas supply to the sample gas inlet on the flowmeter (Figure A2, item 3), not to the Multi Purpose.

APPENDIX

A7 OPTIONAL SAMPLE CONDITIONING PANEL

A7.1 Overview

- + A drying tube is not supplied if your Multi Purpose has the sample conditioning panel fitted, as the panel has an integral drier.

The optional sample conditioning panel allows for use of the Multi Purpose to measure the oxygen content of wet gas samples, for example on a spot-check basis (when close control of boiler efficiency is not required), or while carrying out boiler performance surveys.

Refer to Figure A3. If you order this option, the sample conditioning panel (2) will be supplied fitted to the side of the Multi Purpose (1).

During sampling, sample gas passes through the catchpot (6), and then the drier (3, which contains a drying agent), before passing into the Multi Purpose.

You must drain the catchpot when necessary (see Section A7.7) and you must regularly regenerate or replace the drying agent (see Section A7.8).

A7.2 Specification

Response time *	
Standard oxygen sensor	60 seconds
Industrial or high accuracy oxygen sensor	65 seconds
IR (infrared) sensor	130 seconds
Sample gas temperature †	Ambient temperature ± 10 °C/18 °F
Sample gas inlet #	Suitable for 4 mm inside diameter tube
Drying agent	Indicating silica gel

* The response times are approximate and are those necessary to reach 90% of final measurement, with indicating silica gel as the drying agent. If required, you can use calcium sulphate as the drying agent (see Section A7.8), to reduce response time to approximately 50 seconds.

† For maximum operating life and efficiency.

On the sample conditioning panel (Figure A3, item 7).

A7.3 Using the Multi Purpose with the sample conditioning panel

A7.4 Calibrating

You must calibrate the Multi Purpose with the sample conditioning panel as described in Section 6.1, but you must connect the calibration gas supply to the sample gas inlet on the sample conditioning panel (Figure A3, item 7).

A7.5 Sampling gases

- + If the sample gases are very dirty (that is, contain soot or particulates), we recommend that you use the catchpot as a bubbler when you carry out sample measurements; that is: remove the top of the catchpot and fill the catchpot with clean water to a level just above the bottom of the gas inlet pipe in the catchpot.

- + If you are sampling flue gases, ensure that you position the end of the sample pipe/probe at a location in the flue where the gases are representative of the boiler combustion products.

To obtain the best results from flue gas sampling, we recommend that you locate the end of the sample pipe/probe as close as possible to the centre of the flue duct. If the end of the sample pipe/probe is too close to the wall of the flue duct, the gases sampled may not be representative of the boiler combustion products because of the stratification of the gases, or because of leaks in the duct.

Refer to Figure A3. When you want to sample gases:

1. Ensure that the inlet pipe (4) from the sample conditioning panel is connected to the sample gas inlet on the front of the Multi Purpose (Figure 1, item 8).
2. Take sample readings as described in Section 6.2, but note that:
 - You must connect a gas sample pipe/probe to the sample gas inlet (7) on the sample conditioning panel.
 - Route the end of the sample pipe/probe to a suitable sample point (see above).
 - Allow sufficient time for the sample measurement to stabilise (see Section A7.2).

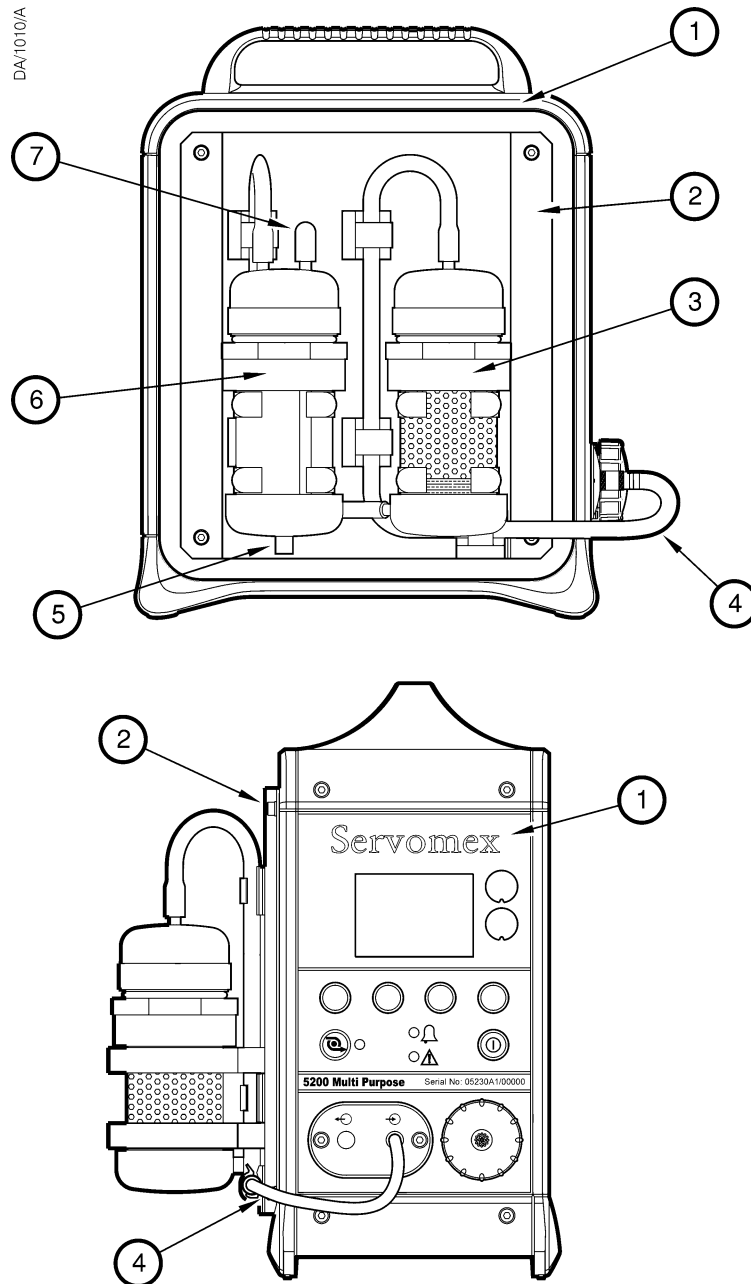

Key	Description	Key	Description
1.	Multi Purpose	5.	Catchpot drain plug
2.	Sample conditioning panel	6.	Catchpot
3.	Drier	7.	Sample gas inlet
4.	Inlet pipe		

Figure A3 - Multi Purpose with the sample conditioning panel

A7.6 Additional maintenance

A7.7 Draining the catchpot

- + Do not allow the level of liquid in the catchpot to rise above the top of the transparent body of the catchpot.

Refer to Figure A3. During use, liquid entrained in the sampled gases will be condensed in the catchpot (6).

When necessary (that is, when liquid is visible in the transparent body of the catchpot):

1. Place a suitable container under the catchpot drain plug (5).
2. Remove the drain plug and allow the liquid to drain from the catchpot.
3. Refit the drain plug and safely dispose of the drained liquid: refer to Section 9.2.

A7.8 Replacing/regenerating the drying agent

	<p style="text-align: center;">WARNING</p> <p>If you replace the drying agent, ensure that you comply with any safe handling and usage requirements specified on or with the package containing the new drying agent.</p>
--	--

- + If required, replace the silica gel drying agent supplied with calcium sulphate (for example, use Drierite[®]), to reduce the response time: see Section A7.2.

The colour of the silica gel drying agent in the drier is orange as supplied, and the column of drying agent will turn progressively green as moisture is absorbed. When the whole column of drying agent has turned green, the drying agent needs to be regenerated or replaced.

You can regenerate the drying agent by passing dry air or dry nitrogen through the drier, or:

- Removing it from the drier and laying it out on a tray, approximately 1 granule thick.
- Heating the silica gel on the tray in an oven at a temperature of 110 to 120 °C (230 to 248 °F) until the granules have turned orange again, or heating the calcium sulphate (Drierite[®]) on the tray at a temperature of 210 °C (425 °F) for 1 hour.

The drying agent supplied will turn orange again when it has been successfully regenerated. More than 100 regenerations can be made before the drying agent becomes ineffective.

When necessary, dispose of the drying agent and replace with new drying agent, available as a spare (see Section A7.9).

A7.9 Additional spares

The following additional spares are available for the sample conditioning panel:

Spare	Part Number
Drying agent (indicator silica gel)	203742
Drying agent (calcium sulphate)	1734-2524
Drier assembly	S5000944
Catchpot assembly	S0214905
Catchpot and drier lids	S5000943

Order these spares from Servomex or your Servomex agent.

APPENDIX

A8 OPTIONAL GAS PROBE ACCESSORY

A8.1 Overview

The gas probe accessory enables you to accurately pinpoint where gases will be sampled.

Refer to Figure A4. The accessory consists of the removable protective tip (1, only supplied with the 25 cm Probe accessory), the probe (2) and handle (3), an optional filter (4), and a coiled sample pipe (5) which is terminated by an outlet connector (6).

A8.2 Preparing for use

If the gas probe is not already assembled, simply push-fit the components together as shown in Figure A4.

A8.3 Using the probe

- + If your probe has a protective tip, remove the tip if the temperature of the location where you will sample gases exceeds 180 °C/356 °F.

Refer to Figure A4. When you want to use the gas probe accessory during gas sampling:

1. Fit the outlet connector (6) to one of the following:
 - The sample gas inlet on the Multi Purpose (see Figure 1)
 - The sample gas inlet on the flowmeter, if fitted (see Figure A2)
 - The sample gas inlet on the sample conditioning panel (see Figure A3), using the catchpot inlet adaptor (7).
2. Place the end of the probe (1) where you want to sample gases.

A8.4 Additional maintenance

If your gas probe accessory has an optional filter:

- When necessary, replace the filter element, available as a spare: see Section A8.5.
- When necessary (for example, if it is damaged), replace the filter assembly, available as a spare: see Section A8.5.

A8.5 Additional spares

The following additional spares are available for the gas probe accessory:

Spare	Part Number
Filter assembly	222393
Filter element (pack of 5)	00570982
Probe: 25 cm (approx 10 inch), with protective tip	S5000942
Probe: 100 cm (approx 39 inch)	S5000404B

Order these spares from Servomex or your Servomex agent.

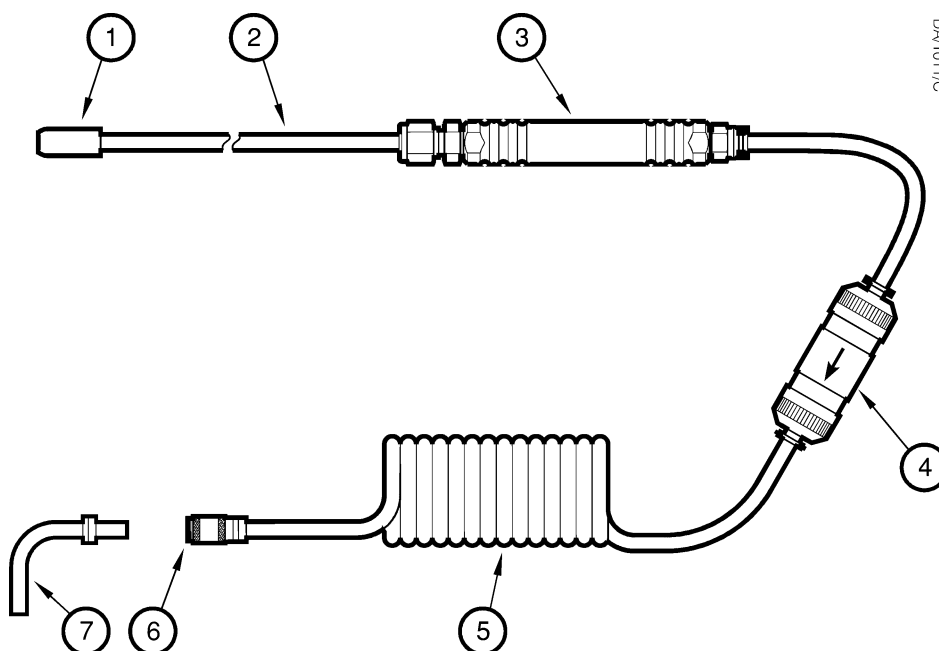

Key	Description	Key	Description
1.	Protective tip *	5.	Coiled sample pipe
2.	Probe	6.	Outlet connector
3.	Handle	7.	Catchpot inlet adaptor #
4.	Filter †		

* Removable: only supplied fitted to the 25 cm Probe.

† Optional.

Only supplied if you also have the sample conditioning panel option.

Figure A4 - Optional gas probe assembly

APPENDIX

A9 MATERIALS IN CONTACT WITH SAMPLE AND CALIBRATION GASES

The materials of the parts of the Multi Purpose in contact with the sample and calibration gases are listed below. These materials have a wide range of chemical compatibility and corrosion resistance.

Common gas path in the Multi Purpose:

- Nickel
- Viton[®]
- 302 stainless steel *
- PPS (polyphenylene sulphide) with carbon fibre filler
- PPS (polyphenylene sulphide) †
- Borosilicate glass
- Kynar[®] (PVDF: polyvinylidene fluoride)
- Polysulphone
- Carbon T94 #
- Carbon P-7454 #
- POM (polyoxymethylene) #

Standard oxygen sensor:

- 316 stainless steel
- Borosilicate glass
- PPS (polyphenylene sulphide) with PTFE (polytetrafluoroethylene)/glass filler
- Gold
- Platinum/iridium alloy
- Nickel
- Epoxy adhesive (EPO-TEK H72)
- Polypropylene
- Viton[®]
- Krytox[®] GPL205 grease

* Standard Multi Purpose without internal sample pump only.

† Standard Multi Purpose with internal sample pump only.

Multi Purpose HF only.

Industrial or high accuracy oxygen sensor:

- 316 stainless steel
- Borosilicate glass
- Platinum
- Platinum/iridium alloy
- Electroless nickel
- Viton®

IR (infrared) sensor:

- 316 stainless steel
- Gold
- Nickel
- Sapphire
- Epoxy adhesive (EPO-TEK H72)
- Viton®

Optional Flowmeters:

- Acrylic
- Nickel
- Polyurethane
- Viton®
- 316 stainless steel
- PVC (polyvinylchloride)

Optional Sample Conditioning Panel:

- Perspex
- PVC (polyvinylchloride)
- Nitrile
- 316 stainless steel
- Fluorocarbon elastomer (FPM)
- Silica
- Fibreglass
- Viton®
- Nickel

Optional Gas Probe:

- 316 stainless steel
- Nickel
- Viton®
- Polyurethane
- Nylon
- Borosilicate glass
- PVC (polyvinylchloride)

APPENDIX

A10 DISPOSAL IN ACCORDANCE WITH THE WASTE ELECTRICAL AND ELECTRONIC EQUIPMENT (WEEE) DIRECTIVE

The label shown in Figure A5 is fitted to the analyser.



Figure A5 - The WEEE label

This label identifies that:

- The analyser is considered to be within the scope of the Waste Electrical and Electronic Equipment (WEEE) Directive 2002/96/EC.
- The analyser is not intended for disposal in a municipal waste stream, but shall be submitted for material recovery and recycling in accordance with the local regulations which implement the WEEE Directive.

For additional information and advice on the disposal of the analyser in accordance with the requirements of the WEEE Directive, contact Servomex or your local Servomex agent.

- + If you send the analyser to Servomex or your local Servomex agent for disposal, the analyser must be accompanied by a correctly completed decontamination certificate.

APPENDIX

A11 COMPLIANCE AND STANDARDS INFORMATION

- The 5200 Multi Purpose Gas Analyser complies with the European Community "Electromagnetic Compatibility Directive", 89/336/EEC (as amended by 92/31/EEC and 93/68/EEC).
- The 5200 Multi Purpose is excluded from the scope of the European Community "Low Voltage Directive", 73/23/EEC.
- The 5200 Multi Purpose has been assessed to IEC 61010-1:2001 (+Corr 1: 2002 + Corr 2:2003) for electrical safety, rated in accordance to IEC 60664-3 Category II, Pollution Degree 2.
- The 5200 Multi Purpose has been validated and fully complies with the requirements of The Food and Drug Act - specifically, 21 CFR 211.165 (e) and 211.194 (a)(2) - for verification of the strength, identity and purity of: MEDICAL OXYGEN (USP) and OXYGEN IN NITROGEN NF 19.
- The power supply unit supplied with the 5200 Multi Purpose complies with the European Community "Low Voltage Directive", 73/23/EEC.
- Servomex Group Ltd is a BS EN ISO 9001:2000 and EN ISO 14001:1996 certified organisation.

This page intentionally blank.