

SIEMENS



Ultrasonic Transmitters

SITRANS Probe LU (Profibus PA)

Operating Instructions

Edition

08/2017

Safety Guidelines: Warning notices must be observed to ensure personal safety as well as that of others, and to protect the product and the connected equipment. These warning notices are accompanied by a clarification of the level of caution to be observed.

Qualified Personnel: This device/system may only be set up and operated in conjunction with this manual. Qualified personnel are only authorized to install and operate this equipment in accordance with established safety practices and standards.

Unit Repair and Excluded Liability:

- The user is responsible for all changes and repairs made to the device by the user or the user's agent.
- All new components are to be provided by Siemens.
- Restrict repair to faulty components only.
- Do not reuse faulty components.

Warning: Cardboard shipping package provides limited humidity and moisture protection. This product can only function properly and safely if it is correctly transported, stored, installed, set up, operated, and maintained.

This product is intended for use in industrial areas. Operation of this equipment in a residential area may cause interference to several frequency based communications.

Note: Always use product in accordance with specifications.

Copyright Siemens AG 2017. All Rights Reserved

Disclaimer of Liability

This document is available in bound version and in electronic version. We encourage users to purchase authorized bound manuals, or to view electronic versions as designed and authored by Siemens. Siemens will not be responsible for the contents of partial or whole reproductions of either bound or electronic versions.

While we have verified the contents of this manual for agreement with the instrumentation described, variations remain possible. Thus we cannot guarantee full agreement. The contents of this manual are regularly reviewed and corrections are included in subsequent editions. We welcome all suggestions for improvement.
Technical data subject to change.

European Authorized Representative

Siemens AG
Industry Sector
76181 Karlsruhe
Deutschland

- For a selection of Siemens level measurement manuals, go to: **www.siemens.com/processautomation**. Select Products & Systems, then under Process Instrumentation, select *Level Measurement*. Manual archives can be found on the Support page by product family.
- For a selection of Siemens weighing manuals, go to: **www.siemens.com/processautomation**. Under Products & Systems, select *Weighing and Batching Systems*. Manual archives can be found on the Support page by product family.

Table of Contents

Safety Notes	1
The Manual	2
Application Examples	2
Abbreviations and Identifications	2
SITRANS Probe LU (PROFIBUS PA)	4
Applications	5
Level, volume, or flow	5
SITRANS Probe LU System Implementation	5
Programming	6
SITRANS Probe LU (PROFIBUS PA) Approvals and Certificates	6
Specifications	7
Installation	11
Mounting Location	11
Mounting Instructions	12
SITRANS Probe LU Dimensions	13
Flange Adaptor (optional)	13
Wiring	15
Power	15
Connecting the SITRANS Probe LU	15
Startup	17
Startup Display (RUN mode)	17
Programming SITRANS Probe LU (PROFIBUS PA)	18
The handheld programmer	18
PROGRAM Mode Display.....	19
Security.....	19
Quick Setup	20
Activating SITRANS Probe LU	20
Setting the PROFIBUS address via the handheld programmer	20
Performing calibration via PROFIBUS PA	21
Using Auto False Echo Suppression	22
Level application example	22
Remote operation via PROFIBUS PA	23
SIMATIC PDM	23
Device Description	23
Configuration	24
The GSD file	24
Setting the PROFIBUS address	24
Bus Termination	24
Power Demands	24
Cyclic versus Acyclic Data	25
Cyclic Data	25
Status Byte	26
Condensed Status	27
Diagnostics	29

Diagnosis reply (applies only to cyclic masters)	29
Acyclic Diagnostics	29
Acyclic Extended Diagnostics (General Fault Codes)	31
Acyclic Data	33
Configuration Example	34
Accessing parameters remotely	34
Functions	34
Changing parameter settings	35
Appendix A: Technical References	37
Principles of operation	37
Measurement Response	37
Echo Lock	37
Loss of Echo (LOE)	38
LOE Timer	38
Failsafe Mode	38
Failsafe value	39
Near Range (Blanking)	39
False Echoes	39
Auto False-Echo Suppression	39
Open Channel Monitoring (OCM)	41
Chemical compatibility	41
Appendix B: Troubleshooting	43
General Fault Codes	43
Appendix C: Maintenance	45
Unit Repair and Excluded Liability	45
Appendix D: programming via the handheld programmer	47
Parameter Menu Structure	47
The LCD Display.....	47
Using the handheld programmer	47
Handheld Programmer: key functions in RUN mode	48
Handheld Programmer: key functions in Navigation mode.....	49
Handheld Programmer: key functions in Edit mode	49
Security	49
Local operation enable	49
Write locking	50
Remote operation enable.....	50
How to do a Master Reset	51
Master Reset.....	51
Individual Parameter Reset.....	51
Fault Reset.....	52
Device calibration	52
Appendix E: LCD menu structure	53
Appendix F: PROFIBUS PA Profile Structure	59
PROFIBUS Level Device Design	59
Block Model for recording and processing measured values	59
Description of the blocks	60
Level Transducer Block function groups	60
Analog Input Function Blocks 1 and 2.....	62

Appendix G: Asynchronous Communications Data Map	65
Directory	65
Physical Block 1	65
Analog Input Function Blocks: AIFB1 and AIFB2	68
Level Transducer Block	70
Appendix H: Parameter Descriptions	77
Identification	77
Configuration	77
Device	78
Statistics	80
Input	81
Target Mode	81
Reset Filter	81
Standard Setup	82
Sensor Calibration	84
Measuring Limits	86
Linearization	87
Detailed Setup	90
Output	100
AIFB1	100
AIFB2	103
Certificates and Approvals	104
Device Certification	104
Maintenance settings	104
Remaining Device Lifetime	104
Remaining Sensor Lifetime	104
Service Interval	104
Calibration Interval	105
Condensed Status Setup	105
Condensed Status Mode	105
Appendix J: Hazardous area installations	107
Wiring Details	107
Intrinsically Safe Model	107
FM/CSA	108
EU Equivalency	109
FM/CSA Intrinsically Safe Connection Drawing	113
FM: Class I, Div. 2 Connection Drawing	117
Appendix K: Firmware Revision History	119
Glossary	121
Index	125

Safety Notes

Special attention must be paid to warnings and notes highlighted from the rest of the text by grey boxes.





WARNING: relates to a caution symbol on the product, and means that failure to observe the necessary precautions can result in death, serious injury, and/or considerable material damage.



WARNING¹: means that failure to observe the necessary precautions can result in death, serious injury, and/or considerable material damage.

Note: means important information about the product or that part of the operating manual.

Safety marking symbols

In manual:	On product:	Description
		(Label on product: yellow background.) WARNING: refer to accompanying documents (manual) for details.



WARNING: Changes or modifications not expressly approved by the manufacturer could void the user's authority to operate the equipment.

¹ This warning symbol is used when there is no corresponding caution symbol on the product.

The Manual

Notes:

- Please follow the installation and operating procedures for a quick, trouble-free installation and to ensure the maximum accuracy and reliability of your SITRANS Probe LU (PROFIBUS PA).
- This product is intended for use in industrial areas. Operation of this equipment in a residential area may cause interference to several frequency based communications.
- This manual applies to the SITRANS Probe LU (PROFIBUS PA) only.

This manual will help you set up your SITRANS Probe LU for optimum performance. We always welcome suggestions and comments about manual content, design, and accessibility. Please direct your comments to techpubs.smpi@siemens.com.

For other Siemens level measurement manuals, go to: www.siemens.com/level and look under Level Measurement.

Application Examples

The application examples used in this manual illustrate typical installations using SITRANS Probe LU (PROFIBUS PA). Because there is often a range of ways to approach an application, other configurations may also apply.

In all examples, substitute your own application details. If the examples do not apply to your application, check the applicable parameter reference for the available options.

If you require more information, please contact your Siemens representative. For a complete list of Siemens representatives, please go to: www.siemens.com/processautomation.

Abbreviations and Identifications

Short form	Long Form	Description	Units
AIFB	Analog Input Function Block		
CE / FM / CSA	Conformité Européenne / Factory Mutual / Canadian Standards Association	safety approval	
C _i	Internal capacitance		
DCS	Distributed Control System		
ETFE	Ethylene-tetrafluoroethylene		

Short form	Long Form	Description	Units
FB	Function Block		
I_i	Input current		mA
I_o	Output current		mA
IS	Intrinsically Safe	safety approval	
L_i	Internal inductance		mH
LTB	Level Transducer Block		
μs	microsecond	10^{-6}	Second
PBT	Polybutylene Terephthalate		
PEI	Polyether Imide		
PLC	Programmable Logic Controller		
PVDF	Polyvinylidene fluoride		
ppm	parts per million		
PV	Primary Value	measured value	
SELV	Safety Extra Low Voltage		
SV	Secondary Value	equivalent value	
TVT	Time Varying Threshold	sensitivity threshold	
U_i	Input voltage		V
U_o	Output voltage		V

SITRANS Probe LU (PROFIBUS PA)

SITRANS Probe LU is a 2-wire loop-powered continuous level monitor that uses advanced ultrasonic techniques. The unit consists of an electronic component coupled to the transducer and process connection.

The transducer is available in ETFE (ethylene-tetrafluoroethylene) or PVDF (polyvinylidene fluoride), allowing SITRANS Probe LU to be used in a wide variety of industries and applications using corrosive chemicals.

The ultrasonic transducer contains a temperature-sensing element to compensate for temperature changes in the application.

Communication is via PROFIBUS PA. This device supports acyclic communications from both a PROFIBUS Class I and Class II master. Echoes are processed using Sonic Intelligence[®] which has been field-proven in over 500,000 applications worldwide (ultrasonic and radar).

SITRANS Probe LU is available in three versions

- General Purpose (non-hazardous)
- Intrinsically Safe (with suitable barrier)
- Non-incendive (FM Class I, Div. 2)

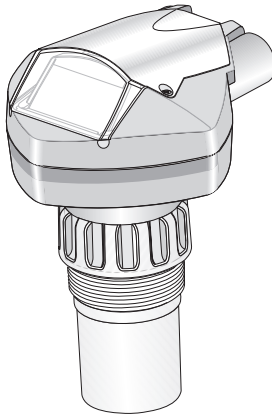

Applications

Level, volume, or flow

SITRANS Probe LU is designed to measure levels of liquids in a variety of applications:

- storage type vessels
- simple process vessels with some surface agitation
- liquids
- slurries
- open channels

Volume

Volume parameters allow you to obtain the measurement as volume instead of level.

Flow

If you have an open channel system (a Parshall flume, v-notch weir, or other open channel device), you can obtain flow values instead of level. By using the linearization parameters, and entering values for Head and Flow breakpoints, you can use SITRANS Probe LU to convert head levels into flow rates.

SITRANS Probe LU System Implementation

SITRANS Probe LU supports PROFIBUS communications protocol and SIMATIC PDM software.

Basic PLC configuration with PROFIBUS PA

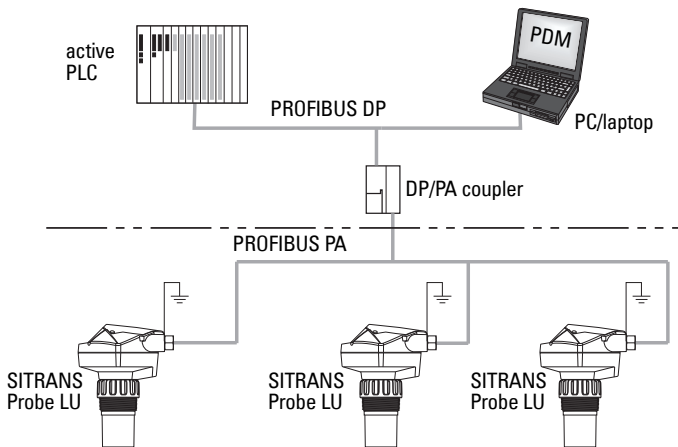

Programming

SITRANS Probe LU carries out its level measurement function according to the set of built-in parameters. Parameter changes can be made via the Siemens infrared handheld programmer, or via a PC using SIMATIC PDM.

SITRANS Probe LU (PROFIBUS PA) Approvals and Certificates

Note: Please see *Approvals* on page 9 for an approvals listing.

Specifications

Note: Siemens makes every attempt to ensure the accuracy of these specifications but reserves the right to change them at any time.

SITRANS Probe LU (PROFIBUS PA)

Power

- Bus powered On PROFIBUS PA, as per IEC 61158-2
- Current consumed 12, 13, 15, or 20 mA, depending on programming¹

Performance

Reference operating conditions according to IEC 60770-1

- ambient temperature +15 to +25 °C
- humidity 45 to 75 % relative humidity
- ambient pressure 860 to 1060 mbar

Measurement accuracy (measured in accordance with IEC 60770-1)

- non-linearity (accuracy) the greater of 6 mm (0.25") or 0.15% of span (including hysteresis and repeatability)²
- non-repeatability 3 mm (0.12") (included in non-linearity specification)
- deadband (resolution) 3 mm (0.12") (included in non-linearity specification)
- hysteresis error 0 mm

Frequency 54 KHz

Measurement range³

- 6 m (20 ft) model: 0.25 m to 6 m (10" to 20 ft) liquid
- 12 m (40 ft) model: 0.25 m to 12 m (10" to 40 ft) liquid

Near Range (blanking)⁴ 0.25 m (10")

¹ See *PROFIBUS Current Consumption* on page 83 for details.

² Non-linearity (accuracy) for marine approved products under severe radiated EMI conditions is the greater of 12 mm or 0.15% of span (including hysteresis and non-repeatability).

³ Reference point for measurement is the transducer face.

⁴ For details, see *Near Range (Blanking)* on page 39.

Update time ¹	
• 12 mA loop current	6.0 s (typical), maximum 16.0 s
• 13 mA loop current	5.0 s (typical), maximum 14.0 s
• 15 mA loop current	3.7 s (typical), maximum 8.0 s
• 20 mA loop current	2.4 s (typical), maximum 4.0 s
Beam angle	10° at –3 dB boundary
Temperature compensation	built in to compensate over temperature range
Memory	
• non-volatile EEPROM	
• no battery required	

Interface

PROFIBUS PA	
• configuration	Siemens SIMATIC PDM (PC), or Siemens infrared handheld programmer
• display (local)	multi-segment alphanumeric liquid crystal with bar graph (representing level)

Mechanical

Process Connections	
• threaded connection	2" NPT, BSP, or G (BS EN ISO 228-1) /PF
• flange connections	3" (80 mm) universal flange
• other connections	FMS 200 mounting bracket, or customer-supplied mount
Transducer (2 options)	
• ETFE (ethylene-tetrafluoroethylene), or	
• PVDF (polyvinylidene fluoride)	
Enclosure	
• body construction	PBT (polybutylene terephthalate)
• lid construction	PEI (polyether imide)
• conduit entry	2 x M20x1.5 cable gland, or 2 x 1/2" NPT thread
• ingress protection	Type 4X/NEMA 4X, Type 6/NEMA 6, IP67, IP68 ² (see note below regarding approved hubs)
Weight	
Standard model	2.1 kg (4.6 lb)

¹ Temperature dependent: typical value at +20 °C (+68 °F); maximum value at +80 °C (+176 °F)
² Submergence test under water at 2 m (6.5 ft) depth for 24 hours.

Environmental

- location indoor/outdoor
- altitude 5000 m (16,404 ft) max.
- ambient temperature -40 to $+80$ °C (-40 to $+176$ °F)
- relative humidity suitable for outdoor
(Type 4X/NEMA 4X, Type 6 /NEMA 6, IP67, IP68 enclosure)
- installation category I
- pollution degree 4
- pressure rating 0.5 bar g/7.25 psi g

Notes:

- Please check the ambient and operating temperatures above; *Process* below; and *Approvals (verify against device nameplate)* below, for the specific configuration you are about to use or install.
- Approved dust-tight and water-tight conduit seals are required for outdoor Type 4X / NEMA 4X, Type 6 / NEMA 6, IP67, IP68 locations..

Process

- temperature (at flange or threads) -40 to $+85$ °C (-40 to $+185$ °F)
- pressure (vessel) 0.5 bar g/7.25 psi g

Approvals (verify against device nameplate)

- General CSA_{US/C}, FM, CE, RCM
- Hazardous Intrinsically Safe: (Europe) ATEX II 1 G Ex ia IIC T4 Ga
(US/Canada) FM/CSA¹: barrier required
Class I, Div. 1, Groups A, B, C, D
Class II, Div. 1, Groups E, F, G
Class III T4
(Brazil) INMETRO DNV 12.0084X
Ex ia IIC T4 Ga
IP67/IP68
 -40 °C \leq Ta \leq $+80$ °C
DNV #OCP 0017
ABNT NBR IEC 60079-0:2008
ABNT NBR IEC 60079-11:2009 e
ABNT NBR IEC 60079-26:2008
- Non-incendive: (US) FM²:
Class I, Div. 2, Groups A,B, C, D T5

¹. See *FM/CSA Intrinsically Safe Connection Drawing* on page 113 for drawing number 23650617.

². See *FM: Class I, Div. 2 Connection Drawing* on page 117 for drawing number 23650583.

Programmer (infrared keypad)

Siemens Infrared IS (Intrinsically Safe) handheld programmer: for all locations, including hazardous.

- approval ATEX II 1GD, Ex ia IIC T4 Ga, Ex iaD 20 T135 °C, SIRA 01ATEX2147
IECEX SIR 09.0073 Ex ia IIC T4 Ga, Ex iaD 20 T135 °C
FM/CSA: Class I, Div. 1, Groups A, B, C, D
- ambient temperature –20 to +50 °C (–5 to +122 °F)
- interface proprietary infrared pulse signal
- power 3V lithium battery (non-replaceable)
- weight 150 g (0.3 lb)
- color black

Installation



WARNINGS:

- **Installation shall only be performed by qualified personnel and in accordance with local governing regulations.**
- **SITRANS Probe LU is to be used only in the manner outlined in this manual, otherwise protection provided by the equipment may be impaired.**

Notes:

- Please refer to the device nameplate for approval information.
- Ideally, mount SITRANS Probe LU so that the face of the transducer is at least 300 mm (1 ft) above the highest anticipated level.

Mounting Location

Recommendations:

- Ambient temperature within -40 to $+80$ °C (-40 to $+176$ °F).
- Easy access for viewing the display and programming via the handheld programmer.
- An environment suitable to the housing rating and materials of construction.
- Keep the sound path perpendicular to the material surface.

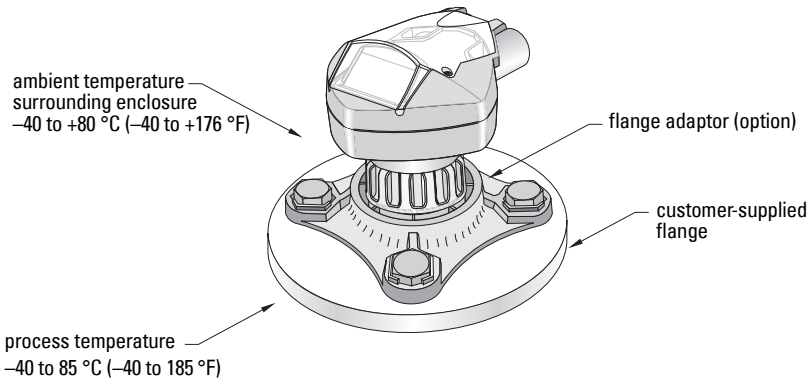

Precautions:

- Avoid proximity to high voltage or current wiring, high voltage or current contacts, and to variable frequency motor speed controllers.
- Avoid interference to the sound path from obstructions or from the fill path

The sound path should be:

- perpendicular to the monitored surface
- clear of rough walls, seams, rungs, or other obstructions
- clear of the fill path

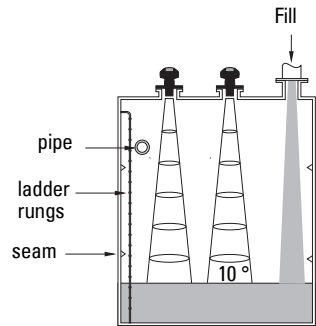
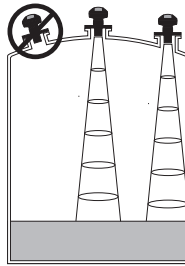

Mounting Instructions

Note:

- Ideally, mount SITRANS Probe LU so that the face of the transducer is at least 300 mm (1 ft) above the highest anticipated level.
- More than one Probe LU can be installed in a vessel. However, best practice would be to place the two units as far apart as possible to avoid interference.

SITRANS Probe LU is available in three thread types:

- 2" NPT
- 2" BSP
- PF2/G (BS EN ISO 228-1)

1. Before inserting SITRANS Probe LU into its mounting connection, ensure that the threads are of the same type to avoid damaging them.
2. Simply screw SITRANS Probe LU into the process connection and hand tighten or using a strap wrench to seat gasket if required (1/4 turn past hand tight is recommended).

SITRANS Probe LU Dimensions

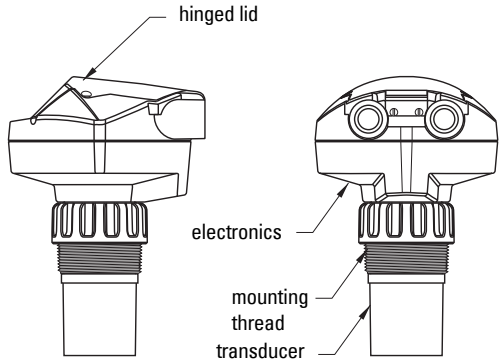
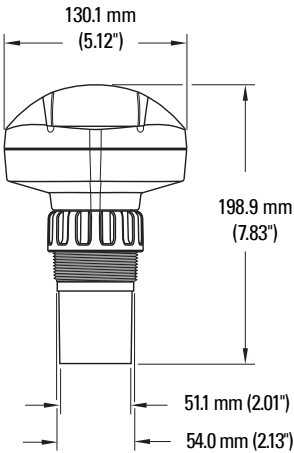
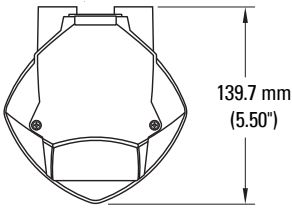

Flange Adaptor (optional)

SITRANS Probe LU can be fitted with the optional 3" (80 mm) flange adaptor for mating to 3" ANSI, DIN 65PN10, and JIS 10K3B flanges.

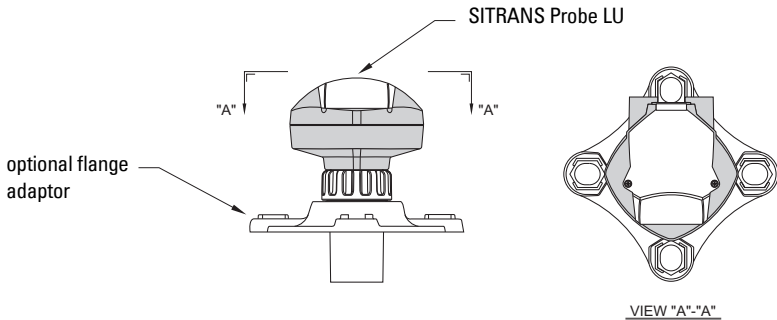

Wiring

Power

WARNINGS:



DC terminals shall be supplied from an SELV¹ source in accordance with IEC-1010-1 Annex H.



All field wiring must have insulation suitable for rated voltages.

Connecting the SITRANS Probe LU

Notes:

- For detailed information on Intrinsically Safe setups, see *Appendix J: Hazardous area installations* on page 107.
- Please see *FM: Class I, Div. 2 Connection Drawing* on page 117 for drawing number 23650583.
- The non-metallic enclosure does not provide a continuous ground path between conduit connections: use grounding-type bushings and jumpers.
- Separate cables and conduits may be required to conform to standard instrumentation wiring practices, or electrical codes.

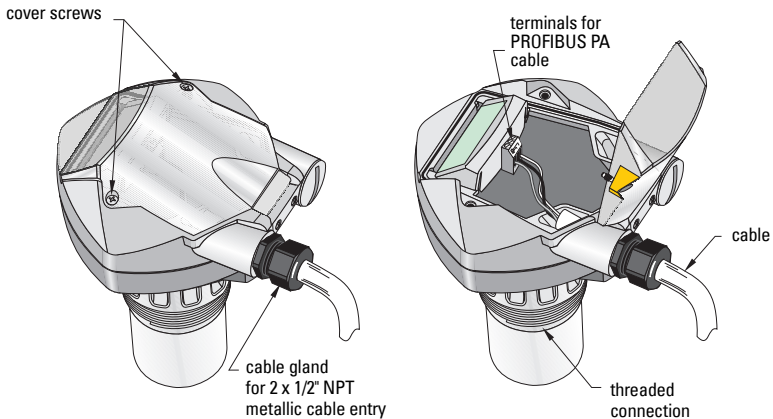

1. Strip the cable jacket for approximately 70 mm (2.75") from the end of the PROFIBUS PA cable, and thread the wires through the gland².

1. Safety Extra Low Voltage
2. If cable is routed through conduit, use only approved suitable-size hubs for waterproof applications.

2. Connect the wires to the terminals as shown below (the Probe LU [PROFIBUS PA] is not polarity-sensitive).

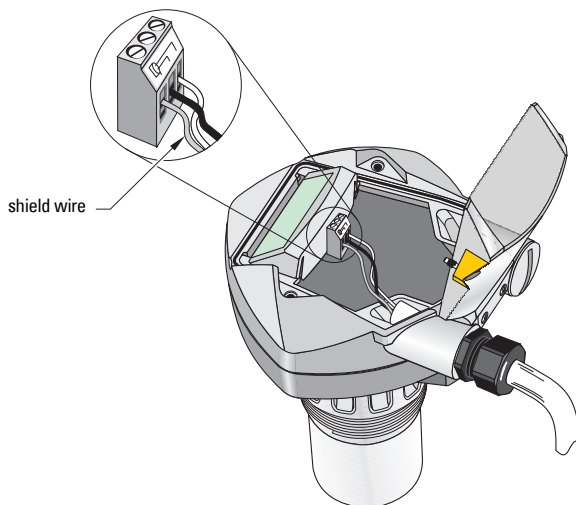

3. Ground the instrument according to local regulations.
 - For Intrinsically Safe applications, connect the cable shield to the instrument shield connection¹, and ground the shield connection to an external ground that is connected to an equal-potential grounding grid. For more detail on Explosion Protection, you can download the brochure *Siemens Process Automation Explosion Protection* (part number A5E00265440) from: www.siemens.com/level, under Brochures/General.
 - For general purpose applications, ground the shield at one point only (usually the power supply side) and continue the shield from device to device, connecting it to the shield connection in each Probe LU.
4. Tighten the gland to form a good seal.
5. Close the cover and tighten screws: **please do not overtighten screws.** Recommended torque is 0.5 to 1.1 N-m (5 to 10 in-lb).

Notes:

- PROFIBUS PA must be terminated at both extreme ends of the cable for it to work properly. Please refer to the *PROFIBUS PA User and Installation Guidelines* (order number 2.092), available from www.profibus.com.
- If the lid gasket is noticeably dry, applying a silicone grease can improve the sealing function.

¹. The instrument shield connection is internally connected to the external ground lug.

Only two steps are necessary for a Quick Setup (see page 20 for detailed instructions):

1. Use the handheld programmer to set the PROFIBUS address locally.
2. Use SIMATIC PDM to calibrate the four set points: High and Low Calibration Point, and High and Low Level Point.

SITRANS Probe LU automatically starts up in **RUN** mode and detects the material level. The LCD displays the material level referenced from the Low Level Point¹ (the output of Analog Input Function Block 1/AIFB1). System status is displayed on the LCD, or on a remote communications terminal.

Note: SITRANS Probe LU (PROFIBUS PA) continues to monitor in and out values even when the device is in PROGRAM mode.

Startup Display (RUN mode)

Normal operation

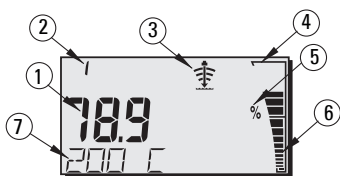

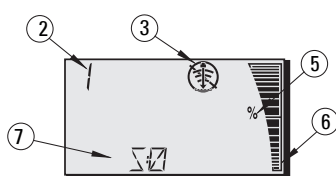

Failsafe operation



1 – Primary region displays material level (Output of the active AIFB)

2 – Menu number (displays the number of the active AIFB: 1 or 2)

3 – Echo status indicator: Reliable Echo  or Unreliable Echo 

(The Unreliable Echo border flashes if LOE is pending². When LOE becomes active, the border is solid and the text region displays S: 0.)

4 – Bar graph border (always visible in RUN mode)

5 – Units or Percent

6 – Active bar graph represents material level

(Lowest bar flashes once per second indicating device is not frozen.)

7 – Secondary region can display one of the following:

- internal electronics temperature
- value representing echo confidence
- distance¹ (Secondary Value 2)
- general status information, or a fault code³

1. See *Calibration* on page 21 for an illustration.

2. See *Loss of Echo (LOE)* on page 38, for more details.

3. For a list of fault codes, their meanings, and corrective actions, please see *Acyclic Extended Diagnostics (General Fault Codes)* on page 31.

Programming SITRANS Probe LU (PROFIBUS PA)



The parameters that control the operation of the Probe LU are organized into function groups, and arranged in a 4-level menu structure that can be accessed either via the handheld programmer, or via PDM and PROFIBUS PA. (For charts showing the complete menu structure, please see *Appendix E: LCD menu structure* on page 53.)

The handheld programmer¹

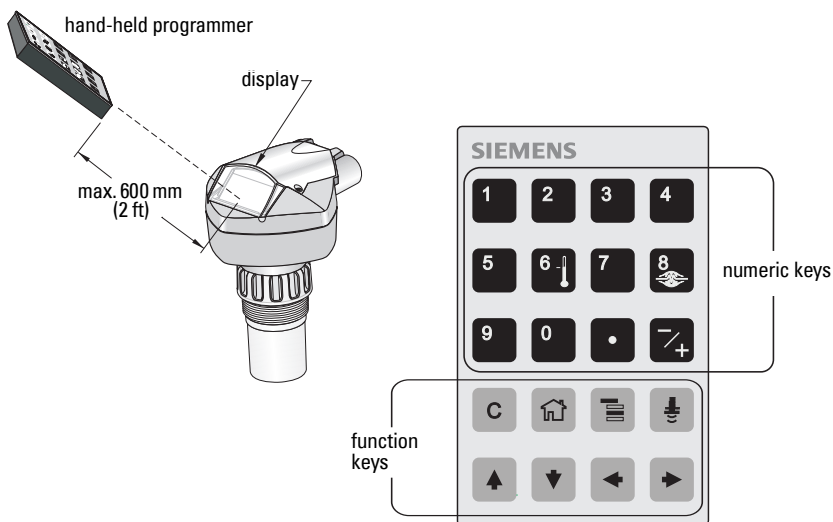
To activate PROGRAM mode, point the handheld programmer at the display from a maximum distance of 600 mm (2 ft), and press the Mode key .



Within Program Mode, the handheld programmer has two sub-modes of operation: Navigation and Edit.

- Press Mode key  to switch from RUN to PROGRAM and enter Navigation Mode: the rightmost digit of the menu number flashes, and the PROGRAM icon  is not visible.
- Press Right arrow a second time to change the mode from Navigation to Edit mode.
- In Edit mode, the PROGRAM icon  appears and flashes.

Note: For Quick Access to parameters via the handheld programmer, press Mode key  to activate PROGRAM mode, then enter the menu number (see *Appendix E: LCD menu structure* on page 53).

¹ For more instructions on local programming using the handheld programmer, please see *Appendix D: programming via the handheld programmer* on page 47.

PROGRAM Mode Display

Note: SITRANS Probe LU (PROFIBUS PA) continues to monitor In and Out values even when the device is in PROGRAM mode.

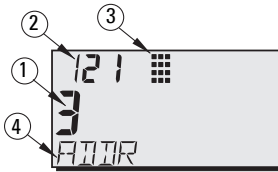

- 1 – Primary region (displays parameter value)
- 2 – Menu number region (displays Menu number)
- 3 – PROGRAM mode icon
- 4 – Secondary region (displays text label)

When you activate PROGRAM mode for the first time in any power cycle, the LCD displays the first menu. If, during the same power cycle, you switch to RUN mode, and then back to PROGRAM mode, then the LCD will display the menu or item that was last accessed in PROGRAM mode.

Security

Local operation enable

Local Operation can be enabled or disabled via PDM (see details under *Setting the PROFIBUS address via the handheld programmer* on page 20).

Write locking

Write locking prevents any changes to parameters, either via PDM or the handheld programmer, but still allows access to the device (see page 80).

Remote operation enable

Remote Operation can be enabled or disabled via the handheld programmer (see page 50).

Master Reset

Open the menu **Device – Master Reset** to access the reset options. (See page 51 for handheld programmer instructions.)

Quick Setup



Activating SITRANS Probe LU





Note: Keep infrared devices such as laptops, cell phones, and PDAs, away from SITRANS Probe LU to prevent inadvertent operation.

Power up the instrument. SITRANS Probe LU starts in **RUN** mode, and the LCD displays the output of AIFB1.

Setting the PROFIBUS address via the handheld programmer ¹

Notes:

- Local programming must be enabled, to allow changes. (In PDM, go to **Identification > Device > Local Operation Enable** and select the desired setting.)
- CLEAR**  can be used to clear the field.
- Press **Right ARROW**  to open Edit mode: the PROGRAM icon flashes.
- Press **Left ARROW**  to cancel Edit mode: the Menu number flashes (the PROGRAM icon is not visible).

- Press **Mode**  to activate **PROGRAM** mode and open Menu level 1.
- Press **Right ARROW**  twice to navigate to PROFIBUS address.
- Press **Right ARROW**  again to open Edit mode: the PROGRAM icon will flash.
- Key in a new value and press **Right ARROW**  to accept it.
The LCD displays the new value; PROGRAM icon disappears, and the last menu digit flashes to indicate Navigation mode.
- Press **Mode**  to return to RUN mode.

Menu level: last digit flashes in Navigation mode.

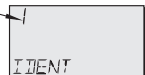

Program icon: flashes in Edit mode.



Right-most digit flashes in Navigation mode.



¹ Default address is 126.

Performing calibration via PROFIBUS PA

To use PROFIBUS PA, you will need a PC configuration tool: we recommend SIMATIC PDM. Please consult the operating instructions or online help for details on using SIMATIC PDM. (An Application Guide *SMPI PROFIBUS PA instruments and SIMATIC PDM* can be downloaded from the Probe LU product page of our website, at: <https://pia.khe.siemens.com/index.asp?Nr=11157>)

Changing parameter settings

- First launch SIMATIC PDM, connect to SITRANS Probe LU, and upload data from the device.
- Adjust parameter values in the parameter view field (right side of screen).
- After adjusting the value, press Enter (the status fields read Changed).
- When you have completed the adjustments, open the Device menu, download data to the device, and save parameter settings offline (the status fields go blank).

Calibration

Only four settings are required for a Quick Setup:

- High Calibration Point and High Level Point
- Low Calibration Point and Low Level Point

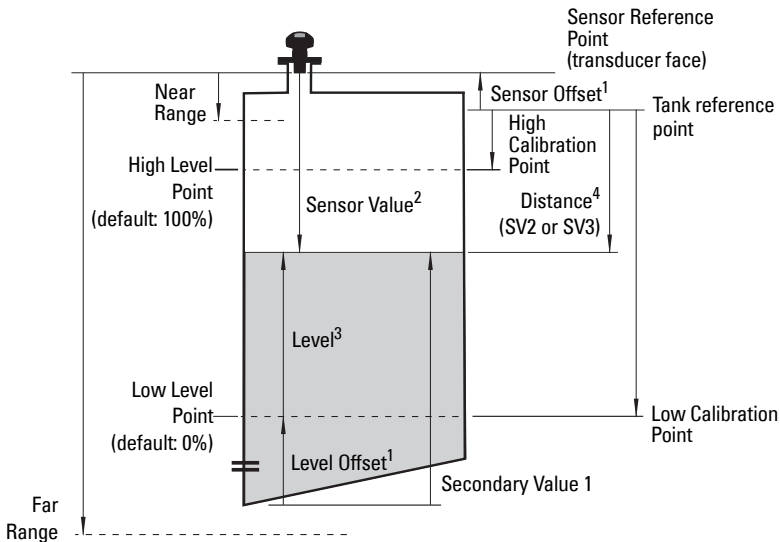

1. Default 0. For more details, see page 86.
2. The value produced by the echo processing, representing the distance from the Sensor Reference Point to the target.
3. Level Value: the level measured in level units.
4. Distance is referenced from the tank reference level to the target (see page 62 for details on SV2 and SV3).

Calibration – steps 1 to 7

1. Open the menu **Device – Sensor Calibration** and select the button **Dry Calibration**. (Click on **Additional Information** to see the schematic showing the PROFIBUS parameters.)
2. Enter the new value for Low Calibration Point (default units are meters).
3. Enter the corresponding value for Low Level Point in percent (default is 0).
4. Enter the new value for High Calibration Point (default units are meters).
5. Enter the corresponding value for High Level Point in percent (default is 100).
6. Click on **Transfer**.
7. SITRANS Probe LU is now ready to operate.

Using Auto False Echo Suppression

If SITRANS Probe LU displays a false high level, or the reading is fluctuating between the correct level and a false high level, you can use the Auto False Echo Suppression parameters to prevent false echo detection. See *TVT setup* on page 97 for instructions.

Level application example

The Primary Value (PV) can be level or volume¹. If volume conversion is not selected, the PV will be the same as the Secondary Value 1 (SV1). SV1 is the sum of level plus level offset (if any).

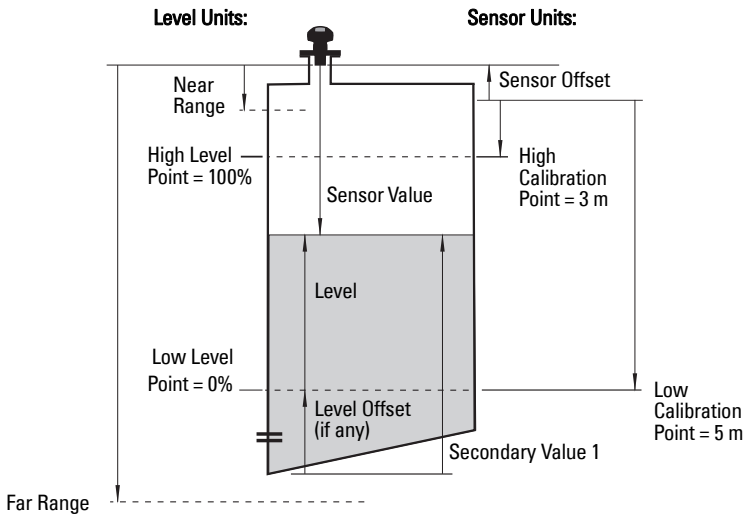

¹ For details, see *How the LTB works*: on page 61.

Remote operation via PROFIBUS PA

SITRANS Probe LU (PROFIBUS PA) is a Class B, Profile Version 3.0, rev. 1, PA device. It supports Class 1 Master for cyclic and acyclic data exchange, and Class 2 for acyclic services. The full range of SITRANS Probe LU functions is available only over a PROFIBUS PA network.

PROFIBUS PA is an open industrial protocol. Full details about PROFIBUS PA can be obtained from PROFIBUS International at www.profibus.com.

To use PROFIBUS PA, you will need a PC configuration tool: we recommend SIMATIC PDM. Please consult the operating instructions or online help for details on using SIMATIC PDM. (You can find more information at www.fielddevices.com: go to Products and Solutions > Products and Systems > Process Device Manager.)

SIMATIC PDM

SIMATIC PDM is a software package used to design, parameterize, commission, diagnose and maintain SITRANS Probe LU and other process devices.

SIMATIC PDM contains a simple process monitor of the process values, alarms, and status signals of the device. SIMATIC PDM allows you to manage process device data in the following ways:

- display
- set
- change
- compare
- check the plausibility
- manage
- simulate

Device Description

In order to use **Process Device Manager (PDM)** with PROFIBUS PA, you will need the Device Description for SITRANS Probe LU, which will be included with new versions of PDM. When you set up a new device, you can locate the Device Description in **Device Catalog**, under **Sensors/Level/Echo/Siemens**. If you do not see **SITRANS Probe LU** under Siemens, you can download it from the product page of our web site at: <https://pia.khe.siemens.com/index.asp?Nr=11157> under **Downloads**.

Configuration

To configure a PROFIBUS PA Class 1 Master (for example, a PLC), you will need a **GSD** file.

The GSD file

The GSD file (SIEM8124.gsd for the 6 m Probe LU; or SIEM8123.gsd for the 12 m Probe LU) is available from the product page of our web site at

<https://pia.khe.siemens.com/index.asp?Nr=11157> under **Downloads**.

Setting the PROFIBUS address

When your instrument is shipped, the PROFIBUS address is set to 126. You can set it locally (see *Setting the PROFIBUS address via the handheld programmer* on page 20) or remotely via the bus, using a parameterization tool such as SIMATIC PDM (see *Device Address (default 126)* on page 77).

Values	Range: 0 to 126
	Pre-set: 126

Bus Termination

Note: In order for PROFIBUS PA to work properly, it must be terminated at both extreme ends of the cable. Please refer to the PROFIBUS PA User and Installation Guidelines (order number 2.092), available from www.profibus.com.

Power Demands

To determine how many devices can be connected to a bus line, calculate the combined maximum current consumption of all the connected devices and allow a current reserve for safety.

In the case of the Probe LU (PROFIBUS PA), the maximum PROFIBUS current is user-selectable, and can be either 12, 13, 15, or 20 mA. (See *PROFIBUS Current Consumption* on page 83.)

Cyclic versus Acyclic Data

When you request data from a device via PROFIBUS PA, there are two possible data transfer methods. Cyclic data is provided at every bus scan: acyclic data is requested and provided as needed.

Input information is always requested at every bus scan and is set up as cyclic data. Configuration information is only needed periodically and is set up as acyclic data.

Cyclic Data

When you configure SITRANS Probe LU on the PROFIBUS PA bus, there are two slots available for modules.

Note: Each of the slots has to have a module defined in it.

Slot 0 always transmits **AIFB1** information¹. Slot 1 defaults to Free Place, but can be changed to **AIFB2** information. If you do not wish to have data transmitted, then you must use a **Free Place** module in that slot.

Each of the two Analog Input Function Blocks can be set up to return **Level**, **Distance**, or **Volume**. Within the function blocks, the values are scaled according to the user requirements (please see *Analog Input Function Blocks 1 and 2* on page 62 for details).

AIFB1 and **AIFB2** return 5 bytes of data each:

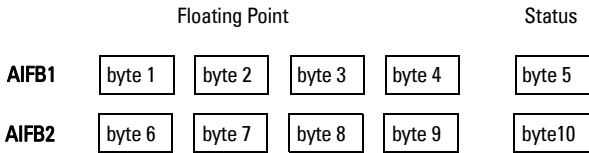

The first 4 bytes are the floating point representation (IEEE) of the variable. The variables are the outputs of the function block. The 5th byte is the status word, and the list of possible values is given in the chart below.

The 5 bytes must be read consistently, in a contiguous chunk: they cannot be read byte by byte, and cannot suffer an interrupt. If you are using an S7-300 / 400, you will need to use SFC14 DPRD_DAT: Read Consistent Data of a Standard PD Slave.

¹ For more information, please see *Analog Input Function Blocks 1 and 2* on page 62.

Status Byte

These codes are available when Condensed Status is not enabled (default state).

Status Codes for Good Quality	
Values in hex notation	Description
0x80	Data is GOOD.
0x84	A parameter in the function block has been changed: status active for 10 s.
0x89	Active low warning.
0x8A	Active high warning.
0x8D	Active low alarm.
0x8E	Active high alarm.

Status Codes for Uncertain Quality	
Values in hex notation	Description
0x4B	Value is a substituted value (normally used in Fail-safe).
0x4C/0x4F	Initial value.
0x47	Last usable value.

Status Codes for Bad Quality	
Values in hex notation	Description
0x10	The LOE timer has expired: this could be caused by LOE or by a sensor malfunction: value is BAD.
0x01	There is an error in the configuration of the function blocks in PROFIBUS PA ^a .
0X1F	The function block, or level transducer block, has been placed out of service.

- ^a. This could happen when a firmware download has been done, but a system reset has not been done. This could also happen if the function blocks are not configured properly using the handheld programmer, PDM or acyclic services.

Condensed Status

These codes are available when Condensed Status is enabled.

Hex value	Status – GOOD	Description
0x80	GOOD – ok	No error or special condition is associated with this value.
0x84	GOOD – update event	Set if the value is good and the block has an active Update event. (This status remains active for 20 seconds.)
0x86	GOOD – active advisory alarm	Set if the value is good and the block has an active Alarm.
0x80 ...0x8E	GOOD – limit check/ update event	See <i>Status Codes for Good Quality</i> on page 26 .
0xA0 ...0xA3	GOOD – initiate fail safe	This fault is not generated by the product, but can be simulated.
0xA4 ...0xA7	GOOD – maintenance required	Value is valid. Maintenance is recommended within a medium-term period.
0xA8 ...0xAB	GOOD – maintenance demanded	Value is valid. Maintenance is demanded within a short-term period.
0xBC ...0xBF	GOOD – function check	Device performs internal function check without influencing the process. Value is valid.

Hex value	Status – UNCERTAIN	Description
0x45	UNCERTAIN – substitute set	Output of Failsafe logic only.
0x4F	UNCERTAIN – initial value	Default value as long as no measured value is available or until a diagnosis is made that affects the value and the status accorded to it.
0x68 ...0x6B	UNCERTAIN – maintenance demanded	Usability of the process value depends on the application. Value is potentially invalid. Cause is a wear ^a detected in the device. Maintenance is demanded within a short-term period.

Hex value	Status – UNCERTAIN	Description (cont'd)
0x73	UNCERTAIN – simulated value, start	<p>Indicates the start of a simulation. Simulation of a measured value or Input FB mode changes from AUTO to MAN.</p> <ul style="list-style-type: none"> This status remains active for at least 10 seconds: <ul style="list-style-type: none"> – after enabling simulation – after setting the FB to MAN mode – after a restart (e.g. power down cycle) if the simulation is enabled or the FB is in MAN mode – after passivation is cleared if simulation is enabled or the FB is in MAN mode In MAN mode the status remains until a subsequent write command overwrites the OUT value after the 10 seconds have expired. In simulation mode the written status is buffered and appears in the value flow after 10 seconds. However the new written SIMULATE parameter with its status can be read before the 10 seconds have expired.
0x74 ...0x77	UNCERTAIN – simulated value, end	<p>Indicates the end of a simulation. Simulation of a measured value is disabled or Input FB mode changes from MAN to AUTO.</p> <p>This Status remains active for 10 seconds after simulation ends.</p> <p>While this status is active there is no reliable process value. Measured values and their status are updated afterwards.</p>

a. See *Wear* on page 123 for more detail.

Hex value	Status BAD	Description
0x00	BAD – non specific	Proxy determines that a device does not communicate.
0x23	BAD – passivated (diagnostics alerts disabled)	Configured failsafe value is used, accompanied by this status.
0x24 ...0x27	BAD – maintenance alarm, more diagnosis available	No measurement available because of a failure.
0x25	BAD – process related, no maintenance	No measurement available because of invalid process conditions.
0x3C ...0x3F	BAD – function check / local override, value not usable	Occurs during cleaning or calibration process.

Diagnosics

All diagnostic information shown below is viewable via PDM.

Diagnosis reply (applies only to cyclic masters)

This is a response to a GET-DIAG message.

During DPV0 data exchange, the PROFIBUS PA slave will notify the Master when a serious error occurs. The Master will then send a Diagnosis request. The reply to this request is normally logged in the PLC and is referred to as the **Hex values**.

The reply may contain two parts. The first part is 6 bytes long and is defined by the PROFIBUS standard. If there is a second part, it is called the **extended diagnostic** and it is eight bytes long. The last four bytes of the extended diagnostic message give the error code shown below. (The same information is also available acyclically via the Diagnosis Object.)

Acyclic Diagnostics

This consists of four bytes.

Hex values	Byte	Bit	Description	Indication class ^a
0x01000000	0	0	Electronics failure	R
0x02000000		1	Mechanical failure	R
0x04000000		2	Motor Temperature too high	R
0x08000000		3	Electronics temperature too high	R
0x10000000		4	Memory error	R
0x20000000		5	Measurement failure	R
0x40000000		6	Device not initialized (no calibration)	R
0x80000000		7	Self calibration failed	R

Hex values	Byte	Bit	Description	Indication class ^a (cont'd)
0x00010000	1	0	Zero point error (limit position)	R
0x00020000		1	Power supply failure (electrical, pneumatic)	R
0x00040000		2	Configuration invalid	R
0x00080000		3	New startup carried out (Warm Start)	A
0x00100000		4	Restart carried out (Cold Start)	A
0X00200000		5	Maintenance required	R
0X00400000		6	Characterization invalid	R
0X00800000		7	Set to 1 (one), if the Ident_Number of the running cyclic data transfer and the value of Physical Block IDENT__NUMBER_SELECTOR parameter are different.	R
	2	0 to 7	Reserved for use within the PNO ^b	
	3	0 to 6	Reserved for use within the PNO	
0X00000080		7	More diagnosis information is available	

- a. **R** indicates the message remains active as long as the reason for the message exists.
A indicates the message will automatically reset after 10 seconds.
- b. PNO – PROFIBUS User Organization

Values of the DIAGNOSIS bit:

0 = not set

1 = set

Acyclic Extended Diagnostics (General Fault Codes)

In addition to the extended diagnostics available by cyclic data exchange (shown above), further extended diagnostics are available via acyclic communications. This consists of six bytes. Please see *Appendix G: Asynchronous Communications Data Map* on page 65 for the location of the **Extended Diagnostics**.

Note: Certain fault codes (identified by an asterisk [*] in the table below) will persist until a manual reset has been performed (see *Reset Fault* on page 78).

LCD display	Cause/symptom	Corrective Action	Byte	Bit
S:0	Device unable to get a measurement within the Fail-safe timer period. Possible causes: faulty installation, material buildup, foaming/ other adverse process conditions, invalid calibration range.	Ensure installation details are correct; ensure no material buildup; adjust process conditions to minimize foam or other adverse conditions; correct range calibration. If fault persist, contact your local Siemens representative.	0	0
S:1	Broken internal HF cable.	Reset power. If fault persists, contact your local Siemens representative: repair required.		1
S:2	No power supply to technology board.	Reset power. If fault persists, contact your local Siemens representative: repair required.		2
S:10	Input parameters High Calibration Point and Low Calibration Point are the same.	Check calibration settings of device. Ensure settings for High Calibration Point and Low Calibration Point are different.	1	3
S:11	Internal temperature sensor has failed.	Repair required: contact your local Siemens representative.		4

Remote Operation : PA

LCD display		Cause/symptom (cont'd)	Corrective Action (cont'd)	Byte	Bit
S:12	*	Internal temperature of the device has exceeded specifications: it is operating outside its temperature range.	Relocate device and/or lower ambient temperature enough to cool device. Inspect for heat-related damage, and contact your local Siemens representative if repair is required. Fault code will persist till a manual reset is performed using PDM or the LCD interface.	1	5
S:14		Upper and Lower input values (Process Value Scale) for AIFB1 are the same.	6		
S:15		Upper and Lower input values (Process Value Scale) for AIFB2 are the same.	7		
S:28		Internal device failure caused by a memory error.	Repair required: contact your local Siemens representative.	3	4
S:29		EEPROM damaged.	Repair required: contact your local Siemens representative.		5
S:30		EEPROM corrupt.	Reset power. If error persist, contact your local Siemens representative: repair required.		6
S:31		Flash error.	Repair required: contact your local Siemens representative.		7
S: 32		IDENT number reported by the device is different from the number used when the PLC was parameterized.	Either use the Ident Number selector to correct the Ident number in the device; or disconnect the class 1 master (PLC), and re-parameterize with the new Ident number.	4	0
S:33		Factory calibration for the internal temperature sensor has been lost.	Repair required: contact your local Siemens representative.		1

LCD display		Cause/symptom (cont'd)	Corrective Action (cont'd)	Byte	Bit
S:34		Factory calibration for the device has been lost.	Repair required: contact your local Siemens representative.	4	2
S:35		Factory calibration for the device has been lost.	Repair required: contact your local Siemens representative.		3
S:36		Factory calibration for the device has been lost.	Repair required: contact your local Siemens representative.		4
S:37		Ultrasonic module hardware defect: Unable to collect profile.	Repair required: contact your local Siemens representative.		5
S:38		Ultrasonic module hardware failure: unable to calculate distance measurement.	Repair required: contact your local Siemens representative.		6
S:39		Transducer temperature sensor failure.	Reset power. If fault persists, contact your local Siemens representative: repair required..		7
S:40		Transducer temperature too high.	Relocate device and/or lower process temperature enough to cool device. Inspect for heat-related damage and contact your local Siemens representative if repair is required.	5	0
S:41		Transducer temperature too low.	Relocate device and/or raise process temperature enough to warm device. Inspect for damage and contact your local Siemens representative if repair is required.		1
S:42		Factory calibration for the transducer temperature sensor has been lost.	Repair required: contact your local Siemens representative.		2

Remote Operation : PA

Acyclic Data

SITRANS Probe LU supports up to four simultaneous connections by a Class 2 Master (C2 connection). It supports one connection by a Class 1 Master (C1 connection).

In order for a Class 1 Master to read parameters from an instrument, it needs to know the slot and absolute index of the parameter.

The parameters are all listed in SIMATIC PDM under Help. If you do not have SIMATIC PDM, you can download the DD and reference the HTML help file directly.

To find the slot and index numbers via SIMATIC PDM, go to **Help > Communications**, and select the appropriate block from the list. For each parameter, the slot and the relative index is listed. For example:

AIFB 1		
Index	Parameter	Datatype
1	Static Revision No.	UNSIGNED_INTEGER (2)

Each block has a slot number and an Index Offset value.

Block Name	Slot	Index Offset
Physical block	0	16
Transducer block	0	77
AIFB 1	1	16
AIFB 2	2	16

To get the the absolute index for any parameter , add the Index Offset for the appropriate block to the relative index for that parameter. The parameter takes the slot number of the block in which it is located.

For example:

- Parameter **Static Revision Number** has relative index = 1 and is located on AIFB1.
- It has Absolute Index = 17 (relative index 1 + index offset 16).
- It is located at Slot 1 (the slot number for AIFB 1).

Configuration Example

To configure and use PROFIBUS PA with an S7-300/ 400 PLC

1. If SITRANS Probe LU is not listed in the STEP 7 device catalog, you can download the GSD file from the product page of our web site at: <https://pia.khe.siemens.com/index.asp?Nr=11157> under **Downloads**.
2. Add the SITRANS Probe LU "rack": click and drag the SITRANS Probe LU folder from the hardware catalog.
3. Fill the "rack" with desired modules by dragging and dropping them from the hardware catalog.
4. After configuring PROFIBUS PA in steps 2 and 3, download it to the PLC.
5. Add code to the PLC program to read data consistently using the SFC14.

Accessing parameters remotely

Functions

The PDM Device Menu gives you access to the following functions:

- Upload from/Download to Device
- Set Address
- Simulation
- Master Reset

- Auto False Echo Suppression
- Write Locking
- Offset and Velocity Calibration
- Sensor Calibration

Changing parameter settings

- First launch SIMATIC PDM, connect to SITRANS Probe LU¹, and upload data from the device (the status fields change to **Loaded**).
- Adjust parameter values in the parameter view field (right side of screen).
- After adjusting the value, press **Enter** (the status fields read **Changed**).
- When you have completed the adjustments, open the **Device** menu, download data to the device, and save parameter settings offline (the status fields go blank).

For a complete list of parameters, please see *Appendix H: Parameter Descriptions* on page 77.

¹. PDM must have the correct device address of your instrument in order to connect.

Appendix A: Technical References

Principles of operation

The transducer emits a series of ultrasonic pulses: each pulse is reflected as an echo from the material and sensed by the transducer. The echo is processed by SITRANS Probe LU, using Siemens proven Sonic Intelligence techniques. Filtering is applied to help discriminate between the true echo from the material and false echoes from acoustic and electrical noise, and agitator blades in motion.

The time for the pulse to travel to the material and back is temperature-compensated, and then converted into distance for display, and a cyclic value for PROFIBUS PA output.

Measurement Response

The measurement response (response rate) limits the maximum rate at which the display and output respond to changes in the measurement. Once the real process fill/empty rate (m/s) is established, a response rate can be selected that is slightly higher than the application rate. The response rate automatically adjusts the filters that affect the output response rate.

There are three preset options: slow, medium, and fast.

Related Parameters	Response Rate	LOE Timer (minutes)	Fill Rate	Empty Rate	Echo Lock	
Values	1 *	slow	100	0.1 m/minute	0.1 m/minute	2 material agitator
	2	medium	10	1 m/minute	1 m/minute	
	3	fast	1	10 m/minute	10 m/minute	

If none of the preset options is satisfactory, the filters can be adjusted individually.

Echo Lock

When the echoes are received, the relevant echo algorithm is applied to determine the true material echo. If the selected echo is within the window, the window is then centered about the echo. Otherwise the window widens with each successive shot until the selected echo is within the window, which then returns to its normal width.

Echo Lock selects the measurement verification process:

Values	0		Off
	1		Maximum Verification
	2	*	Material Agitator
	3		Total Lock

- When Echo Lock is Off, SITRANS Probe LU responds immediately to a new measurement (within the restrictions set by the Maximum Fill / Empty Rate). However, measurement reliability is affected.
- When Maximum Verification or Material Agitator is selected, a new measurement outside the Echo Lock Window must meet the sampling criteria.
- When Total Lock is selected, Echo Lock Window is pre-set to **0**, and the window is automatically calculated after each measurement.

Loss of Echo (LOE)

A loss of echo (LOE) occurs when the calculated measurement is judged to be unreliable because the echo confidence value has dropped below the echo confidence threshold. The LOE timer starts running, and if the LOE condition persists beyond the time limit set by the LOE timer, the Reliable Echo indicator is replaced by the Unreliable Echo indicator.



Reliable Echo indicator



Unreliable Echo indicator: border flashes when LOE is pending.

When LOE is active, border is solid and text region displays **S: 0**

Upon receiving a reliable echo, the loss of echo condition is aborted, the Reliable Echo indicator replaces the Unreliable Echo indicator, and the reading returns to the current level.

LOE Timer

The LOE timer determines the time (in minutes) to elapse after the last valid reading before Failsafe mode is activated. When the LOE timer expires, the material level to be reported is determined by Failsafe Mode.

Failsafe Mode

Failsafe mode defines the reaction of the device if a Failsafe condition is detected. It may be triggered by a loss of echo, a bad configuration, or certain device faults. If Failsafe mode is activated by a fault, the instrument will go into Failsafe mode without delay (see *Acyclic Extended Diagnostics (General Fault Codes)* on page 31).

You can select one of three possible values to be reported when a Failsafe condition occurs:

- Default value (Failsafe value) used as output value.
- Storing last valid output value.
- Calculated output value is incorrect.

Failsafe value

Failsafe value is a user-defined value. This allows you to enter the safest output value for your application.

For example, you may want to select a user-defined high value to prevent an overflow (Failsafe Hi). Or you may want to select a low value to protect a pump from operating dry (Failsafe Lo).

Near Range (Blanking)

The crystal which produces the transmit pulse has to stop vibrating before it can receive an echo. Near Range is the space in front of the transducer face where level measurement is not possible, because within that distance, the echo would return before the vibration had ceased.

The Near Range parameter allows you to set the distance in front of the transducer, within which any echoes will be ignored¹.

False Echoes

False echoes can appear during the receive cycle. They are often created by obstructions within the beam path, such as a ladder rung, and are usually indicated by an incorrect high level reading. Auto False-Echo Suppression is recommended.

Auto False-Echo Suppression

The TVT adjustment parameters allow you to set a TVT (Time Varying Threshold) curve, so that SITRANS Probe LU will ignore false echoes.

The default TVT curve hovers above the echo profile, and effectively screens out small false echoes. But if an obstruction is causing a large echo before the material level echo, that echo will rise above the default TVT curve. You can use Auto False-Echo Suppression to filter it out. If possible, rotate the instrument before using Auto False-Echo Suppression, to lower the amplitude of false echoes.

¹ The reference point for measuring Near Range is the transducer face. The minimum recommended Near Range value is 0.25 m (10"), but this can be increased.

When you set Auto False-Echo Suppression to **Learn**, the instrument learns the echo profile at that moment¹. Then it uses the learned profile instead of the default TVT curve, for the distance set in Auto False Echo Suppression Distance. The learned profile (learned TVT curve) follows the echo profile, so that no large false echoes rise above the learned TVT curve. From the end of the Auto False-Echo Suppression Distance, the default TVT curve is used. The material level echo rises above this, and is selected as the true echo.

Display before Auto False Echo Suppression

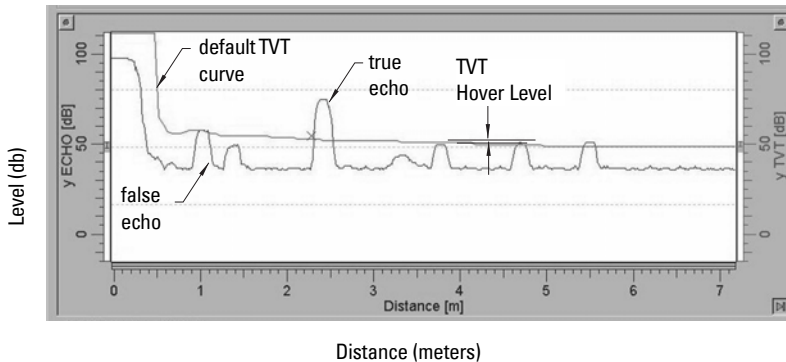

Display after Auto False Echo Suppression

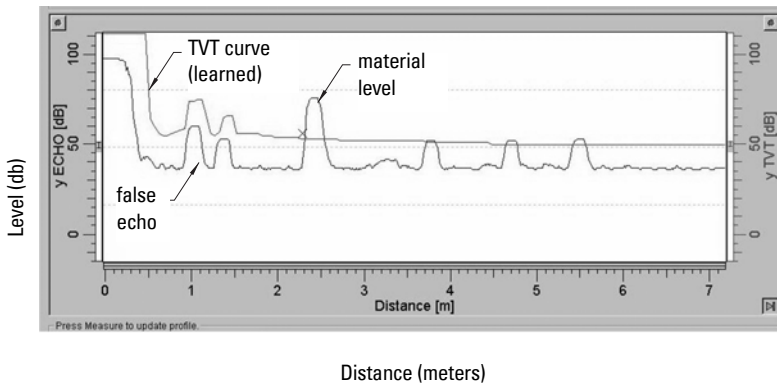

¹ Turn on Auto False-Echo Suppression when the material level is substantially lower than process full level (ideally when the tank is empty or almost empty).

Open Channel Monitoring (OCM)

OCM converts a level reading (head) into a flow value using a linear algorithm.

SITRANS Probe LU can convert a head level measurement into a flow rate, using an eleven breakpoint head-versus-flow characteristic curve. This chart is usually available from the manufacturer of the v-notch weir, Parshall flume, or other open channel device.

Linearization type must be set to **Linearization Table**, and up to 32 breakpoints must be set for head levels and corresponding flowrates (using the Volume tables). Once these breakpoints are set, the output is scaled to represent the flowrate, and the RUN mode display will show the flowrate.

Example: Flow Characterization (using 11 breakpoints)

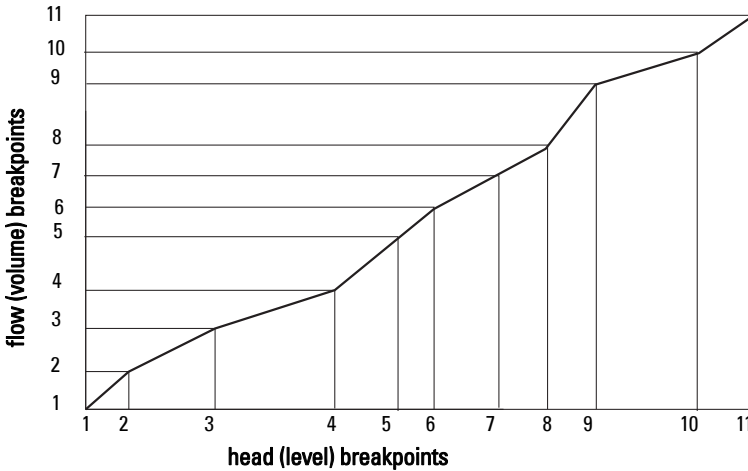

The maximum and minimum points on the curve must be defined. Then program the remaining breakpoints to closely match the flow curve of your open channel device.

Chemical compatibility

The plastic materials used in the construction of SITRANS Probe LU (ETFE, PBT, PEI, and PVDF) are resistant to attack from most chemicals. For exposure to specific environments, check with chemical compatibility charts before installing and operating SITRANS Probe LU in your application.

Appendix B: Troubleshooting

1. Check the following:
 - There is power at the instrument.
 - The LCD shows the relevant data.
 - Check whether any fault codes are being displayed (see *Acyclic Extended Diagnostics (General Fault Codes)* on page 31 for a detailed list).
 - The device can be programmed using the handheld programmer.
2. Verify that the wiring connections are correct.
3. Check the PROFIBUS address and make sure all devices are at unique PROFIBUS addresses.
4. If you are unable to program the device via the handheld programmer, make sure local operation is enabled (see *Local operation enable* on page 49). Also make sure that Write Locking is Off (see *Write locking* on page 50).
5. If you try to set a SITRANS Probe LU parameter via remote communications, but the parameter remains unchanged, make sure remote operation is enabled (see *Remote operation enable* on page 50). Also make sure that Write Locking is Off (see *Write Locking* on page 80).
6. If you continue to experience problems, go to our website at www.siemens.com/processautomation, and check the FAQs for SITRANS Probe LU, or contact your Siemens representative.
7. If the PLC value equals the display value, but does not correspond to actual material level, either:
 - scaling in AIFB1 is incorrect, or
 - High Calibration Point is incorrectly entered, or
 - the wrong echo is being selected.
8. If the PLC value is not equal to the displayed value (regardless of actual material level), either:
 - you may not be looking at the right spot in the PLC, or
 - you may have programmed scaling into the PLC, instead of leaving all scaling to be performed in the Probe LU, or
 - the PCL may not be communicating with the Probe LU. Check the network to verify that you are communicating.

General Fault Codes

For a table listing the fault codes, meanings, and suggested corrective action to take, please see *Acyclic Extended Diagnostics (General Fault Codes)* on page 31.

Appendix C: Maintenance

SITRANS Probe LU requires no maintenance or cleaning.

Unit Repair and Excluded Liability

All changes and repairs must be done by qualified personnel, and applicable safety regulations must be followed. Please note the following:

- The user is responsible for all changes and repairs made to the device.
- All new components must be provided by Siemens Process Instruments Inc.
- Restrict repair to faulty components only.
- Do not re-use faulty components.

Appendix D: programming via the handheld programmer

Although the complete range of parameters is only accessible via PDM¹, you can access and adjust many of the parameters via the Siemens infrared handheld programmer.

- For the complete list of parameters, see *Appendix H: Parameter Descriptions* on page 77.
- *Appendix E: LCD menu structure* on page 53 gives a list of all parameters accessible via the handheld programmer, preceded by the menu number.

Parameter Menu Structure

The parameters are organized into function groups, and arranged in a 4-level menu structure. For example:

- 1. Identification
 - 1.2. Configuration
 - 1.2.2. Remote Lock.

The LCD Display

Details on the LCD display are given in *Startup* on page 17.

Using the handheld programmer

Note: For Quick Access to parameters via the handheld programmer, press the mode key to activate PROGRAM mode, then key in the menu number.

Basic instructions on using the handheld programmer start on page 18, and on doing a Quick Setup start on page 20.



The following pages give details on how to programme some of the more complex SITRANS Probe LU parameters via the handheld programmer.

To activate PROGRAM mode, point the handheld programmer at the display (from a maximum distance of 600 mm [2 ft]), and press the Mode key  (see illustration on page 18).

¹ Please see *Remote operation via PROFIBUS PA* on page 23.

Within Program Mode, the handheld programmer has two sub-modes of operation:

1. Navigation Mode



- Press Mode key  to switch from RUN to PROGRAM and enter Navigation Mode: the rightmost digit of the menu number flashes, and the PROGRAM icon  is not visible.
- Press Up/Down arrows to change the mode number.
- Press Right/Left arrows once to move to the next/previous menu.
- Press Right arrow a second time to change the mode from Navigation to Edit mode.

2. Edit Mode







- In Edit mode, the PROGRAM icon  appears and flashes.
- Press the number keys to enter parameter data.
- Press Right arrow to accept the new value and return to Navigation Mode.
- Only parameter items can be in Edit mode.
- In the case of read-only parameters, no change is permitted.

Note: For Quick Access to parameters via the handheld programmer, press Mode key  to activate PROGRAM mode, then enter the menu number (see *Appendix E: LCD menu structure* on page 53).

Handheld Programmer: key functions in RUN mode







Key	Function
	Updates internal enclosure temperature value and displays it in LCD secondary region.
	Updates echo confidence value and displays it in LCD secondary region.
	Updates measurement value and displays it in LCD secondary region.

Handheld Programmer: key functions in Navigation mode

Key	Name	When displaying:	Navigation Mode
	Up or down arrow	menu or item	Show previous or next menu or item.
	Right arrow	menu	Show first item in the selected menu, or next menu.
		item	Change to Edit mode.
	Left arrow	menu or item	Show parent menu.
	Mode key	menu or item	Change to RUN mode.
	Home key	menu or item	Show first item of top level menu (menu 1, item 1).
		menu or item	Select appropriate item or menu ¹ .

¹ For example, press **3** to move to the third item in the current menu.

Handheld Programmer: key functions in Edit mode

Key	Edit Mode
	Right arrow: accept the data (write the parameter) and change from Edit to Navigation mode.
	Left arrow: cancel Edit mode without changing the parameter.
	Erase the most recently changed character. If this is the first key in Edit mode, erase the display.
	Add a decimal point.
	Change the sign of the entered value.
	Add the corresponding character.

Security



Local operation enable

Local Operation can be enabled or disabled via PDM. Go to **Identification > Device > Local Operation Enable** and select the desired setting.

Write locking

Write locking prevents any changes to parameters, either via PDM or the handheld programmer, but still allows access to the device.

Values	2457 (unlock value)	Off	Enables parameter changes.
	any other value	On	Disables parameter changes.

- Go to **Write Locking:**
 - 1. Identification Menu**
 - 1.3. Configuration**
 - 1.3.5. Lock
 - Press **Right ARROW**  to open Edit mode.
 - Key in **2457** (unlock value) to enable parameter changes.
 - Press **Right ARROW**  again, to accept the change and return to Navigation mode.

Remote operation enable

Remote Operation can be enabled or disabled via the handheld programmer.

Values	0	Remote operation enabled.
	1	Remote operation disabled.

To change the setting:

- Open **Identification** Menu, then scroll down to CONFIG.
- Press **Right ARROW**  to open the Config Menu, then scroll down to REMLOCK.
 - 1. Identification**
 - 1.2. Configuration
 - 1.2.2. Remote Lock
- To enable programming, set REMLOCK to **0**. To disable programming, enter **1**.

How to do a Master Reset

Master Reset

Note: Following a Master Reset, complete reprogramming is required.

	1	Reset all parameters (except PROFIBUS address) to PROFIBUS PA profile default values.
Values	2506	Warm Start: restart the device (this option is rarely used).
	2712	Reset PROFIBUS address to 126.
	32768	Reset to manufacturer's default values (factory settings) ¹ .



Example: do a Profile reset

1. Go to **Reset**



1. Identification Menu

1.2. Configuration

1.2.3. Reset

2. Press the **Right ARROW** key  to open Edit mode.
3. Key in **1 (Profile Reset)** to reset all parameters except PROFIBUS address.
4. Press the **Right ARROW** key  again, to accept the changes and return to Navigation mode.

Individual Parameter Reset

1. Press **Right ARROW** , then **CLEAR** , then **Right ARROW** .
2. The value returns to the default factory setting.

¹ Manufacturer's settings:

AIFB Filter Time Constant = 10 s

LTB values set for 0 - 20 m (Low and High Calibration points; Near Range and Far Range)

Fault Reset

Used to reset a fault message after an active fault has occurred and been corrected. A manual reset is required only for certain faults, identified by an asterisk (*) in the General Fault Code list on page 31.



To reset, key in the value of the fault code in question.

1. Go to **Reset Fault**:

1. Identification Menu

1.2. Configuration

1.2.4. Reset Fault

2. Press the **Right ARROW** key  to open Edit mode.
3. Key in the number of the Fault Code to reset the status to normal operation.
4. Press the **Right ARROW** key  again, to accept the change and return to Navigation mode.

Device calibration

Only four settings are required for a Quick Setup: High Calibration Point, Low Calibration Point, High Level Point, and Low Level Point. (For an illustration, see *Calibration* on page 21.)

2.4. Sensor Calibration:

2.4.1. Sensor Units (default meters)

2.4.2. Calibration Type.

Values	0	*	Dry calibration (preferred)
	1		Wet calibration

2.4.3. Low Calibration Pt.

2.4.4. High Calibration Pt.

2.4.5. Unit [Level] (default percent)

2.4.6. Low Level Point

2.4.7. High Level Point

1. Go to **Calibration Type** and verify that **Dry** Calibration is selected.
2. Go to **Low Calibration Point** and enter the new value (default units are meters).
3. Go to **High Calibration Point** and enter the new value (default units are meters).
4. Go to **Low Level Point** and enter the corresponding value in percent (default is 0).
5. Go to **High Level Point** and enter the corresponding value in percent (default is 100).
6. SITRANS Probe LU is now ready to operate.

Appendix E: LCD menu structure

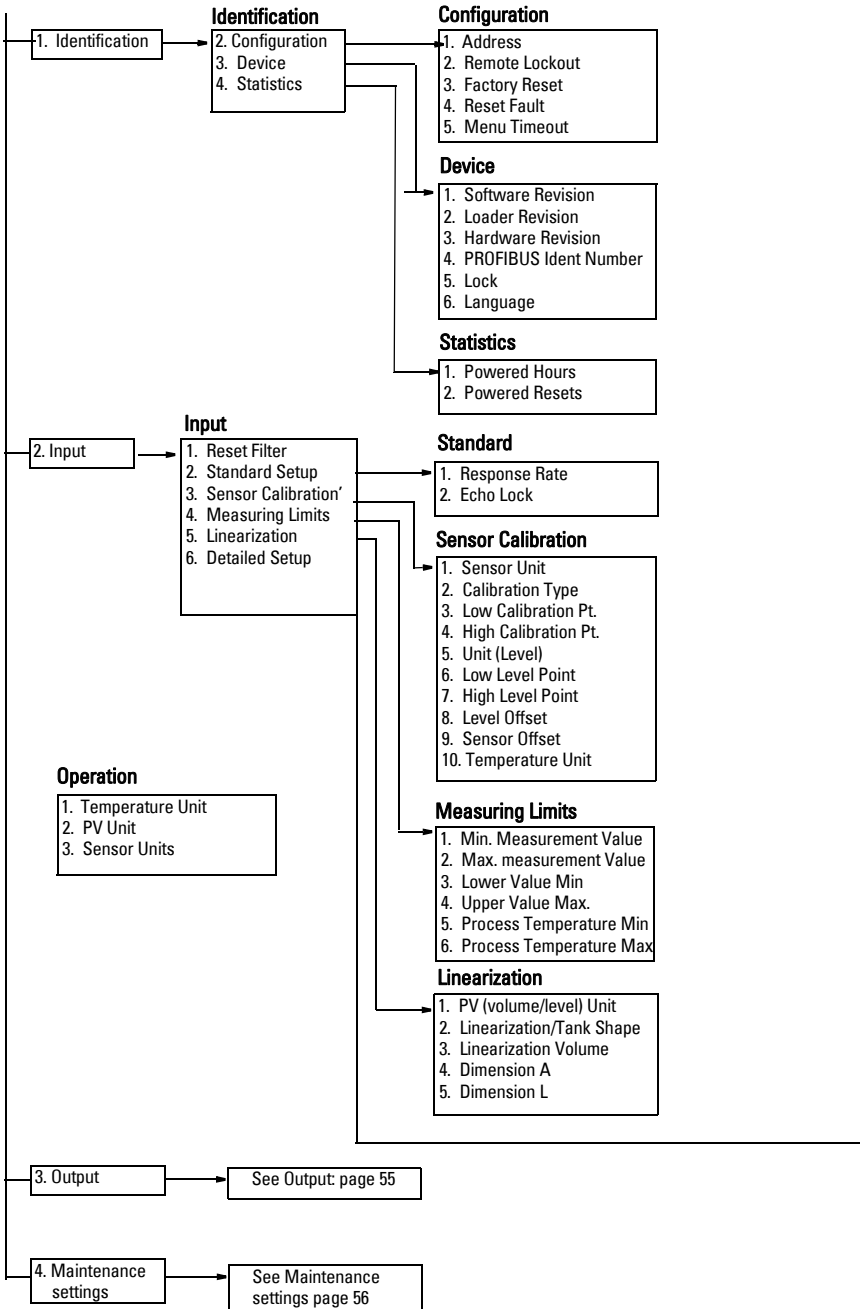

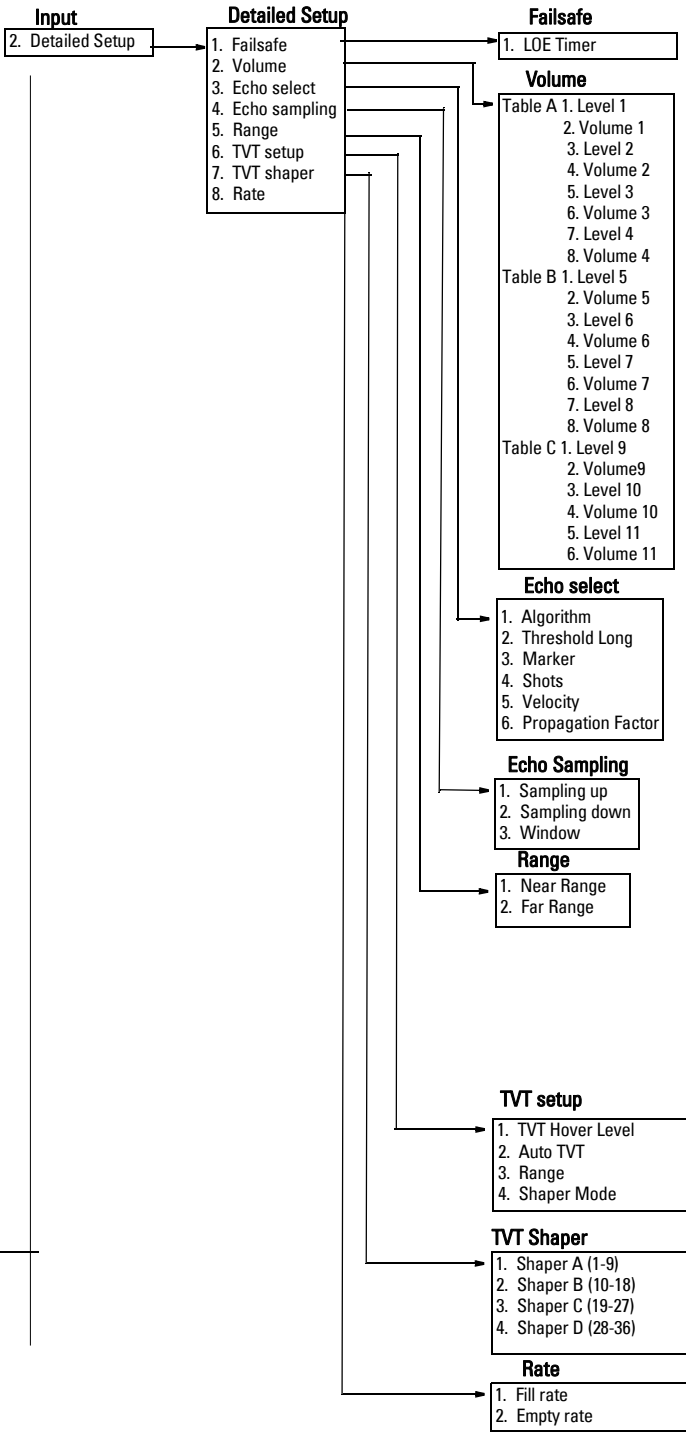

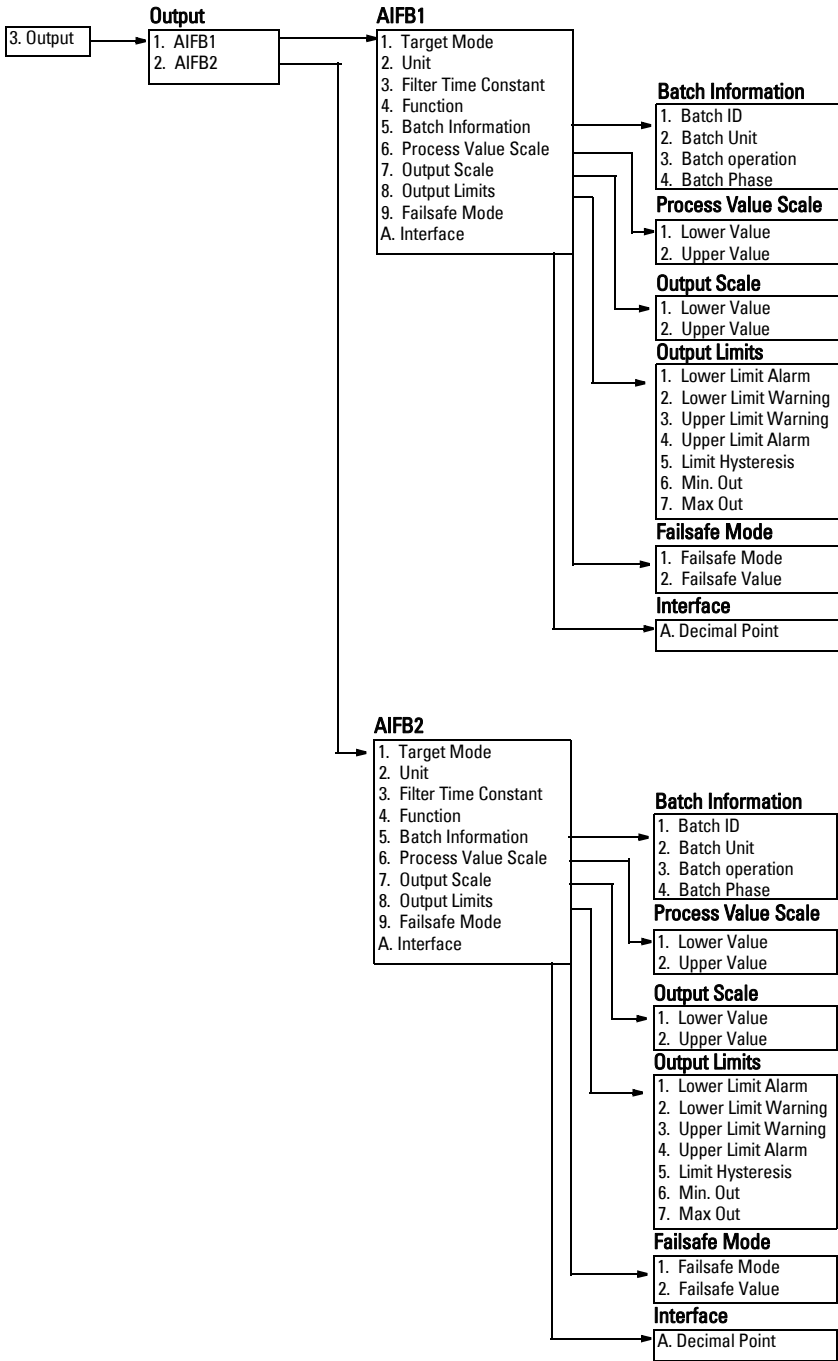

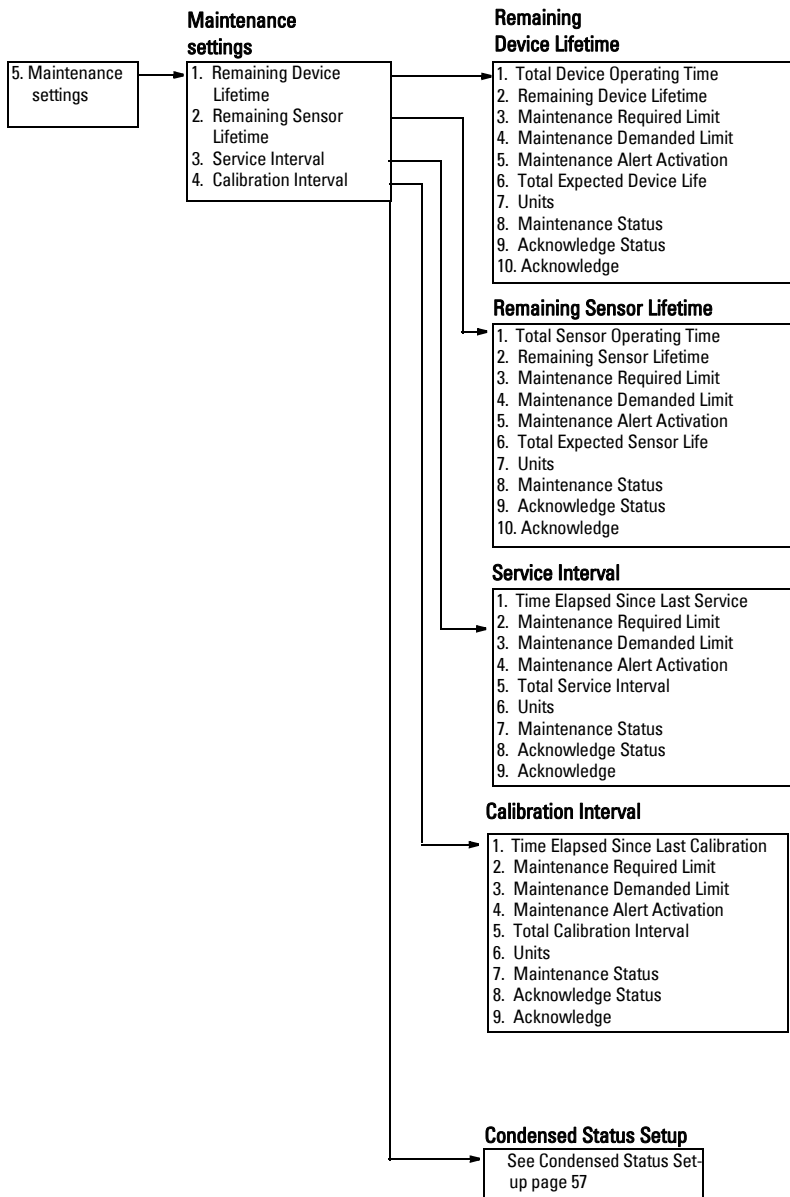

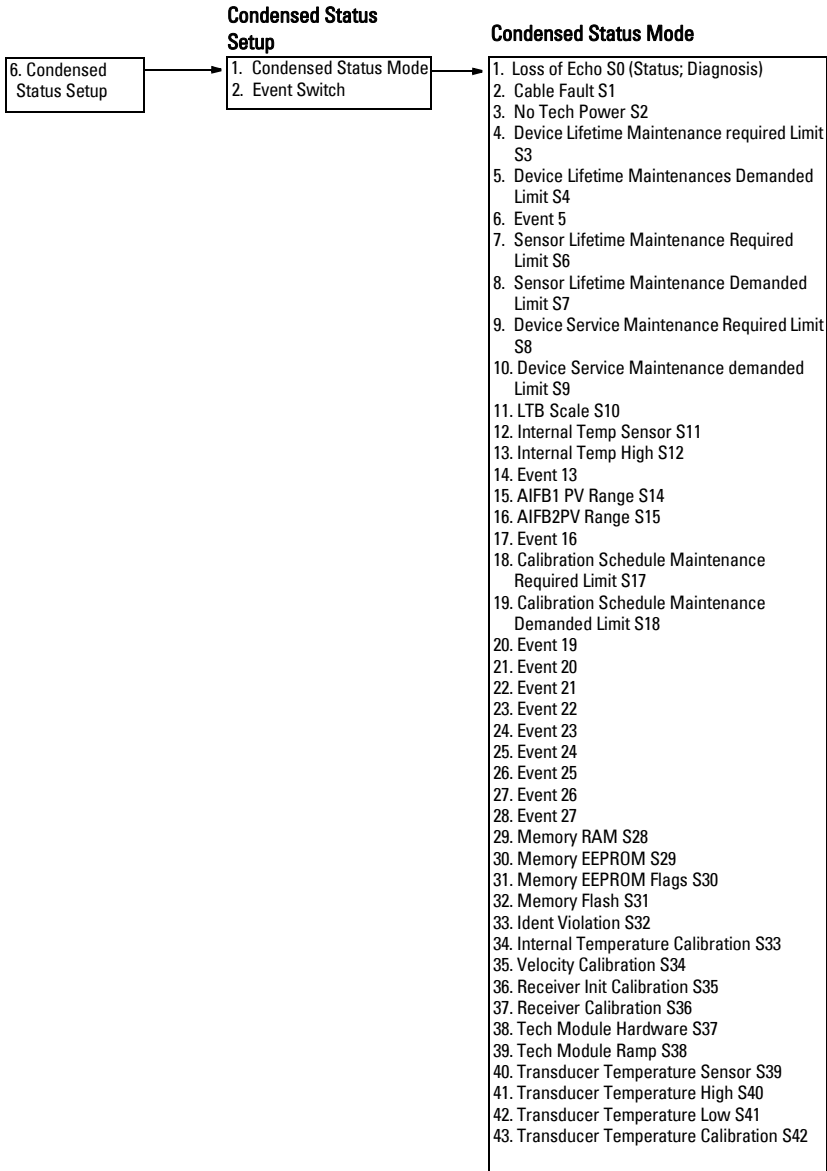

Notes

Appendix F: PROFIBUS PA Profile Structure

PROFIBUS Level Device Design

The device follows the profile block model and is implemented as a Profile 3.0, Rev. 1, Class B, PA device. Standard profile parameters are used to program the level transducer block.

Block Model for recording and processing measured values

The functions of the device are divided into blocks for different areas of responsibility. They can be parameterized by acyclic data transfer via PDM.

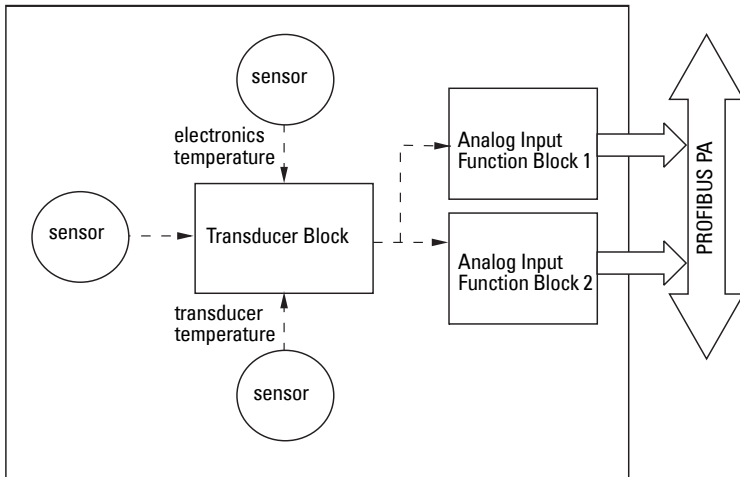

The device is implemented with one Physical Block (PB), one Level Transducer Block (LTB), and two Analog Input Function Blocks (AIFB1 and AIFB2).

All data is viewed from the perspective of the DCS or PLC, so information from the sensor is an input.

Level Transducer Block (LTB)

The Level Transducer Block carries out adjustments to the sensor, such as level calibration and volume calibration. It supplies the outputs used by either or both of the AIFBs.

Analog Input Function Blocks AIFB1 and AIFB2

The two Analog Input Function Blocks are completely independent of each other. They use the output from the Level Transducer Block, and apply any required quality checks, scaling, and Failsafe operation selections.

The output of an Analog Input Function Block supplies the measured value and associated status information to PROFIBUS PA, via cyclic data transfer.

Description of the blocks

Level Transducer Block function groups

The figure below shows the signal flow of measured values from the sensor through the transducer block into the output value (Primary Value/ Level or Volume; Secondary Value 1/Level; Secondary Value 2 /Distance 1; or Secondary Value 3/ Distance 2). The LTB implements all of the basic parameters (see parameter diagram on page 61), including level to volume calculation, if that option has been selected.

Level Transducer Block

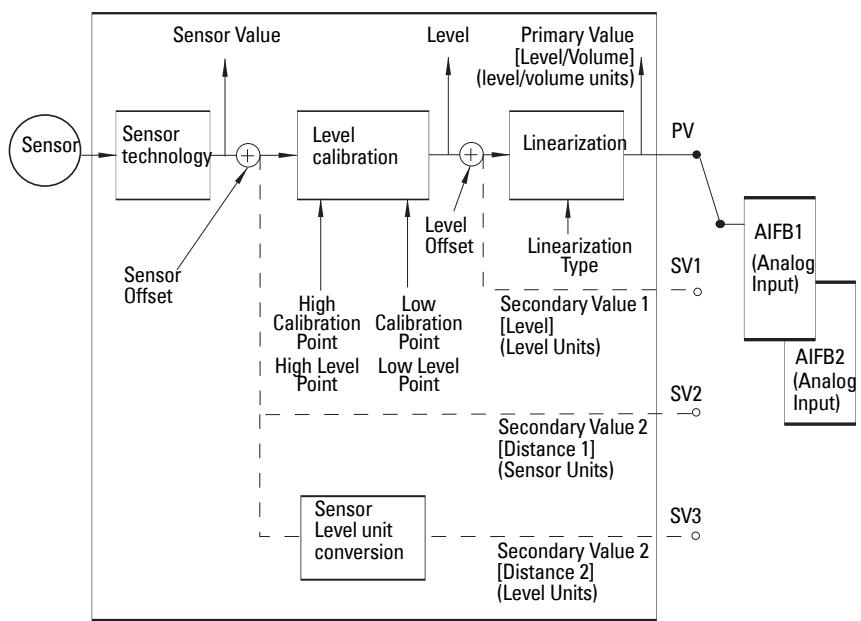

How the LTB works:

1. The sensor technology block selects the proper echo. For an explanation of sensor technology, please refer to *Appendix A: Technical References* on page 37.
 The sensor value (in sensor units) is checked to see if it is within its measuring limits. If the limit is exceeded, this results in a **Bad** status and the error message **Failure in measurement**. The sensor value is stored in Sensor Value.
 The analog signal from the sensor is transformed into a digital signal.
 A Sensor Offset (default 0) provides compensation if necessary for changes in the sensor.
2. Level Calibration is a linear transfer function that converts a sensor value to a level value. The level value is used for volume calculation, if that function is enabled.

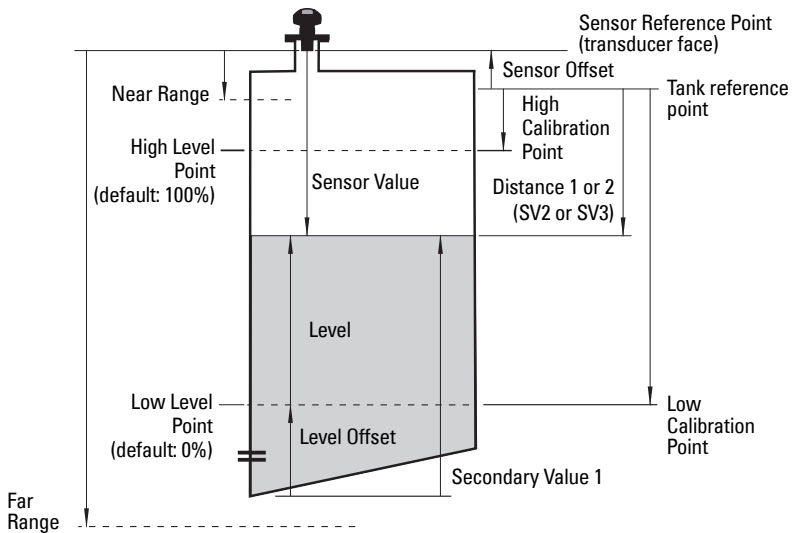
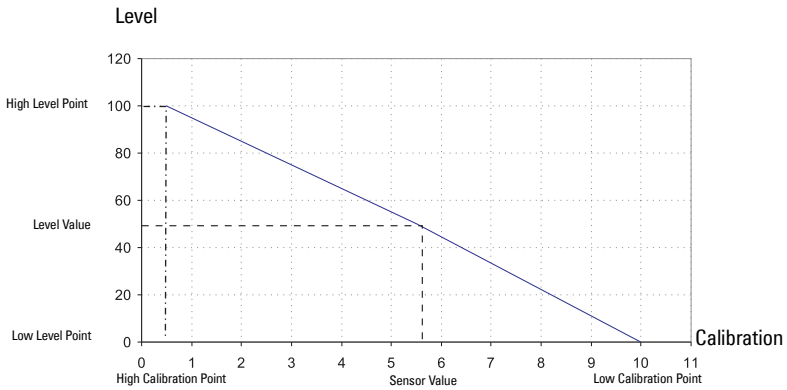

3. Then linearization can be carried out to accommodate complex tank shapes, or to provide level to volume conversion.
4. The LTB provides four possible outputs
 - Primary Value (PV) / Level or Volume
 - Secondary Value 1 (SV1) / Level
 - Secondary Value 2 (SV2) / Distance 1 (sensor units)
 - Secondary Value 3 (SV3) / Distance 2 (any level units, except %)

Electronics temperature

The transducer block also monitors the internal temperature of the device electronics. If the temperature exceeds permitted limits, it does not change the sensor value, but it does change the status. The permitted limits correspond to the permitted ambient temperature limits.

If a temperature limit is exceeded, the status changes. Peak indicators¹ allow you to check the maximum and minimum temperatures that have occurred.

Analog Input Function Blocks 1 and 2

The figure below shows how measured values are processed within the two Analog Input Function Blocks to produce the device outputs, which are communicated via cyclic transfer to PROFIBUS PA, and displayed on the LCD.

Analog Input Function Block function groups (simulation, mode, and status)

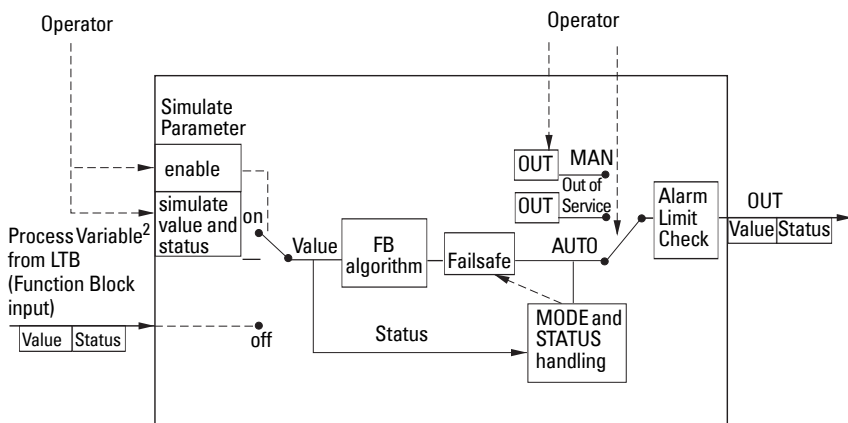

1. Open View menu, scroll down to Peak Values, and click on Temperature tab in the Peak Values window.
2. The output from the Level Transducer Block can be called the Primary Value (PV) or Secondary Value (SV1, SV2, or SV3). When it becomes the input to the AIFB, it is called the Process Variable.

How the AIFBs work

The Analog Input Function Blocks allow you to control modifications to the output value (PROFIBUS cyclic data).

Output Conversion

Values transmitted by the Level TB have a status attached. The decision on what to do with each value is made by the Analog Input Function Block.

Device/ Input Simulation

The input can be a simulated value instead of a TB OUT value. This allows the AI block to be tested independently of the characteristics of the environment.

Failsafe

If the status of the Primary Value or Simulation Value is **bad**, the fault logic can output either the last usable measured value, or a given substitute value.

Device / Output Simulation

One of three settings can be selected:

Setting	description	Output value
AUTO	automatic	the automatically-recorded measured value
MAN	manual	a manually-set fixed simulation value
O/S	function block disabled	the preset safety value.

- The result is the output parameter (OUT).

AIFB execution steps:

The AIFBs can provide a linear conversion to any desired units.

1. The input value is normalized (Scaling Input)

Process Variable range applies to any of the four LTB values. (Units of the Process Variable scale are the same as the units used for the LTB output.) Output units together with Process Variable range determine how the LTB output is converted to whatever units the customer wants.

2. The scaling output is applied.

For example:

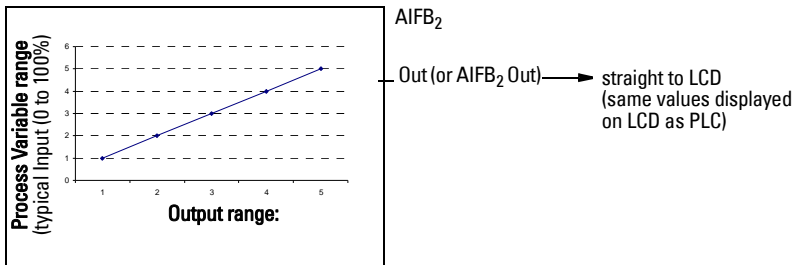

3. This value is filtered using a first order filter based on a time constant provided by the user.
4. The status of the Process Variable (input value) is checked. If the status is Bad, a Failsafe condition occurs. The output is determined by the Failsafe Mode of the block.
5. The target mode parameter allows the entire AI block to be overridden by a Manual Out value.
6. The value is checked against the user parameterized warning and alarm limits. (There is an upper and lower warning limit and an upper and lower alarm limit. The unit of the limits corresponds to the unit of the output range. A hysteresis parameter prevents toggling in the Status field of the OUT value.)
7. The OUT VALUE parameter is the value for the cyclic data transfer.

Appendix G: Asynchronous Communications Data Map

Directory

Slot	Index	Value	Description	Size (bytes)	
1	0	1	Directory Header		
		1	1 - Directory ID		
		3	1 - Revision Number		
		8	3 - Number of entries		
		3	8 - Directory Entries		
1	1	0x01040001	List Directory		
		0x02050002	Entry Index No. of blocks		
		0x03070002	1 4 1 (1 PB, at Index 4)	4	
	2	3	0x014D008A	2 5 2 (2 TBs, at Index 5)	4
				3 7 2 (2 FBs, at Index 7)	4
	4	5	0x00100053	Directory	
				Slot Index No. of parameters	
				0 16 83 Physical Block	4
				0 100 30 (Internal Use Only)	4
				1 77 138 Transducer Block	4
				1 16 47 AIFB1	4
	7	8	0x0110002F	2 16 47 AIFB2	4
0x0210002F					

Physical Block 1

This is the only physical block for the device.

Relative Index	Name	Access Structure	Type	
0	Block Object	r	Reserved	UNSIGNED_FLOAT (2)
			Block Object	INTEGER (1)
			Parent Class	INTEGER (1)
			Class	INTEGER (1)
			DD Reference	UNSIGNED_INTEGER(4)
			DD Revision	UNSIGNED_INTEGER(2)
			Profile	INTEGER (2)
			Profile Revision	INTEGER (2)
			Execution Time	UNSIGNED_INTEGER (1)
			Number of Parameters	UNSIGNED_INTEGER(2)
			Index of View 1	UNSIGNED_INTEGER(2)
			Number of views	UNSIGNED_INTEGER(1)

Relative Index	Name	Access	Structure	Type (cont'd)
1	ST REV	r	Value	UNSIGNED_INTEGER(2)
2	Tag	r/w	Value	ASCII(32)
3	Strategy	r/w	Value	UNSIGNED_INTEGER(2)
4	Alert Key	r/w	Value	UNSIGNED_INTEGER (1)
5	Target Mode	r/w	Value	UNSIGNED_INTEGER (1)
6	Mode Block	r	Actual Mode	UNSIGNED_INTEGER (1)
			Permitted Modes	UNSIGNED_INTEGER (1)
			Normal Mode	UNSIGNED_INTEGER (1)
7	Alarm Summary	r	Current States	UNSIGNED_INTEGER (1)
			Unacknowledged	UNSIGNED_INTEGER (1)
			Unreported	UNSIGNED_INTEGER (1)
			Disabled	UNSIGNED_INTEGER (1)
8	Software Revision	r	Value	ASCII(16)
9	Hardware Revision	r	Value	ASCII(16)
10	Manufacturer ID	r	Value	UNSIGNED_INTEGER (2)
11	Device ID	r	Value	ASCII(16)
12	Serial Number	r	Value	ASCII(16)
13	Diagnosis	r	Value	UNSIGNED_INTEGER (4)
14	Diagnosis Extension	r	Value	BYTE (6)
15	Diagnosis Mask	r	Value	UNSIGNED_INTEGER (4)
16	Diagnosis Ext Mask	r	Value	BYTE (6)
17	Certification	r	Value	ASCII(32)
18	Write Locking	r/w	Value	UNSIGNED_INTEGER(2)
19	Factory Reset	r/w	Value	UNSIGNED_INTEGER(2)
20	Descriptor	r/w	Value	ASCII(32)
21	Device Message	r/w	Value	ASCII(32)
22	Installation Date	r/w	Value	ASCII(16)
23	Local Operation Enable	r/w	Value	UNSIGNED_INTEGER (1)
24	PROFIBUS Ident	r/w	Value	UNSIGNED_INTEGER (1)
26	Features Supported	r	Value	INTEGER (4)
	Features Enabled	r/w	Value	INTEGER (4)
27	Condensed Status Mode	r/w	Value	INTEGER (1)
28	Condensed Status Setup	r/w	Value	Byte array (50)
42	Order Number	r		ASCII (32)

Relative Index	Name	Access	Structure	Type (cont'd)
43	Language	r/w		UNSIGNED_INTEGER (1)
44	Reserved			
45	Reserved			
46	Device Wear	r	Powered Hours	UNSIGNED_INTEGER (4)
			Poweron Resets	UNSIGNED_INTEGER (2)
47	Reserved			
48	Reserved			
49	Date of Birth	r	Value	ASCII (16)
50	Total Device Operating Time (seconds)	r	Value	UNSIGNED_INTEGER (4)
51	Loader Revision	r	Value	ASCII (16)
53	PROFIBUS Current Consumption	r/w	Value	INTEGER (1)
54	LCD Contrast	r/w	Value	INTEGER (1)
70	Remaining Device Lifetime	r	Remaining Device Lifetime	UNSIGNED_INTEGER (4)
			Status	BIT_ENUMERATED (1)
			Maintenance ack	BIT_ENUMERATED (1)
71	Device Lifetime	r/w	Maintenance Required Limit	UNSIGNED_INTEGER (4)
			Maintenance Demanded Limit	UNSIGNED_INTEGER (4)
			Maintenance Alarm Activation	BIT_ENUMERATED (1)
72	Total Expected Device Life	r/w	Total Expect Device Life	UNSIGNED_INTEGER (4)
			Lifetime Maintenance Ack	INTEGER (1)
73	Time Elapsed Since Last Calibration	r/w	Value	UNSIGNED_INTEGER (4)
74	Status	r	Status	BIT_ENUMERATED (1)
			Maintenance Calibration ack	BIT_ENUMERATED (1)
75	Calibration Interval	r/w	Maintenance Required Limit	UNSIGNED_INTEGER (4)
			Maintenance Demanded Limit	UNSIGNED_INTEGER (4)
			Maintenance Alarm Activation	INTEGER (1)
76	Total Calibration Interval	r/w	Total Calibration Interval	UNSIGNED_INTEGER (4)
			Calibration acknowledge	INTEGER (1)
77	Extended Diagnostics	r	Value	BIT_ENUMERATED (6)

Analog Input Function Blocks: AIFB1 and AIFB2

Each of the two Analog Input Function Blocks can be set up to return **Level**, **Distance**, or **Volume**. Within the function blocks, the values are scaled according to the user requirement.

Relative Index	Name	Access	Structure	Type
0	Block Object	r	Reserved	UNSIGNED_INTEGER (1)
			Block Object	INTEGER (1)
			Parent Class	INTEGER (1)
			Class	INTEGER (1)
			DD Reference	UNSIGNED_INTEGER(4)
			DD Revision	UNSIGNED_INTEGER(2)
			Profile	INTEGER (2)
			Profile Revision	INTEGER (2)
			Execution time	UNSIGNED_INTEGER (1)
			Number of Parameters	UNSIGNED_INTEGER(2)
			Address of View 1	UNSIGNED_INTEGER(2)
Number of views	UNSIGNED_INTEGER(1)			
1	ST REV	r	Value	UNSIGNED_INTEGER(2)
2	Tag	r/w	Value	ASCII(32)
3	Strategy	r/w	Value	UNSIGNED_INTEGER(2)
4	Alert Key	r/w	Value	UNSIGNED_INTEGER (1)
5	Target Mode	r/w	Value	UNSIGNED_INTEGER (1)
6	Mode Block	r	Actual Mode	UNSIGNED_INTEGER (1)
			Permitted Modes	UNSIGNED_INTEGER (1)
			Normal Mode	UNSIGNED_INTEGER (1)
7	Alarm Summary	r/w	Current States	UNSIGNED_INTEGER (2)
			Unacknowledged	UNSIGNED_INTEGER (2)
			Unreported	UNSIGNED_INTEGER (2)
			Disabled	UNSIGNED_INTEGER (2)
8	Batch Information	r/w	Batch ID	UNSIGNED_INTEGER(4)
			Batch Unit	UNSIGNED_INTEGER (2)
			Batch Operation	UNSIGNED_INTEGER(2)
			Batch Phase	UNSIGNED_INTEGER(2)
10	OUT	r/w	Output Value	FLOAT (2)
			Quality	UNSIGNED_INTEGER (1)
			Status	UNSIGNED_INTEGER (1)
11	PV Range	r/w	Upper	FLOAT (2)
			Lower	FLOAT (2)

Relative Index	Name	Access	Structure	Type (cont'd)
12	Output Scale	r/w	Upper	FLOAT (2)
			Lower	FLOAT (2)
			Units	UNSIGNED_INTEGER(2)
			Decimals	INTEGER (1)
13	Characterization Type	r/w	Value	UNSIGNED_INTEGER (1)
14	Function	r/w	Value	UNSIGNED_INTEGER (2)
16	Filter Time Constant	r/w	Value	FLOAT (2)
17	Failsafe Mode	r/w	Value	INTEGER (1)
18	Failsafe Default Value	r/w	Value	FLOAT (2)
19	Limit Hysteresis	r/w	Value	FLOAT (2)
21	Upper Limit Alarm	r/w	Value	FLOAT (2)
23	Upper Limit Warning	r/w	Value	FLOAT (2)
25	Lower Limit Warning	r/w	Value	FLOAT (2)
27	Lower Limit Alarm	r/w	Value	FLOAT (2)
34	Quality	r	Quality	INTEGER (1)
			Status	INTEGER (1)
			Simulation Value	FLOAT (2)
			Simulation Enabled	INTEGER (1)
35	Out Unit Text	r		ASCII(16)
45	Max Out Value	r/w		FLOAT (2)
46	Min Out Value	r/w		FLOAT (2)

Level Transducer Block

This is the main transducer block for the device. (A second block is for internal use only.)

G: Data Map

Relative Index	Name	Access	Structure	Type
0	Block Object	r	Profile Parameter	UNSIGNED_INTEGER(1)
			Block Object	INTEGER(1)
			Parent Class	INTEGER(1)
			Class	INTEGER(1)
			DD Reference	UNSIGNED_INTEGER(4)
			DD Revision	UNSIGNED_INTEGER(2)
			Profile	INTEGER(2)
			Profile Revision	INTEGER(2)
			Execution Time	UNSIGNED_INTEGER(1)
			Number of Parameters	UNSIGNED_INTEGER(2)
			Index of View 1	UNSIGNED_INTEGER(2)
			Number of views	UNSIGNED_INTEGER(1)
1	Static Revision Number	r	Value	UNSIGNED_INTEGER(2)
2	Tag	r/w	Value	ASCII(32)
3	Strategy	r/w	Value	UNSIGNED_INTEGER(2)
4	Alert Key	r/w	Value	UNSIGNED_INTEGER(1)
5	Target Mode	r/w	Value	UNSIGNED_INTEGER(1)
6	Mode Block	r	Actual Mode	UNSIGNED_INTEGER(1)
		r/w	Permitted Modes	UNSIGNED_INTEGER(1)
		r/w	Normal Mode	UNSIGNED_INTEGER(1)
7	Alarm Summary	r/w	Current States	UNSIGNED_INTEGER(2)
			Unacknowledged	UNSIGNED_INTEGER(2)
			Unreported	UNSIGNED_INTEGER(2)
			Disabled	UNSIGNED_INTEGER(2)
8	PV (Level/ Volume)	r	Value (Level/Volume)	FLOAT(2)
			Status (Level/Volume)	INTEGER(1)
9	PV Units (Level/ Volume)	r/w	Value	INTEGER(2)
10	Measured Value (Level)	r	Value	FLOAT(2)
11	Level Units	r/w	Value	UNSIGNED_INTEGER(2)
12	Sensor Value	r	Value	FLOAT(2)
13	Sensor Units	r/w	Value	INTEGER(2)

Relative Index	Name	Access Structure	Type (cont'd)	
14	SV1	r	Level	FLOAT (2)
			Status (Level)	INTEGER (1)
15	SV1 Units	r/w	Value	INTEGER (2)
16	SV2	r	Distance	FLOAT (2)
			Status (Distance)	INTEGER (1)
17	SV2 Units	r/w	Value	INTEGER (2)
18	Sensor Offset	r/w	Value	FLOAT (2)
19	Calibration Type	r/w	Value	UNSIGNED_INTEGER (1)
20	Low Calibration Point	r/w	Value	FLOAT (2)
21	High Calibration Point	r/w	Value	FLOAT (2)
22	Low Level Point	r/w	Value	FLOAT (2)
23	High Level Point	r/w	Value	FLOAT (2)
24	Level Offset	r/w	Value	FLOAT (2)
25	Linearization Type	r/w	Value	INTEGER (1)
26	Diameter	r/w	Value	FLOAT (2)
27	Linearization Volume	r/w	Value	FLOAT (2)
28	Max. Sensor Value	r	Value	FLOAT (2)
29	Min. Sensor Value	r	Value	FLOAT (2)
30	Max Measured Value	r/w	Value	FLOAT (2)
31	Min Measured Value	r/w	Value	FLOAT (2)
32	Process Temperature	r	Value	FLOAT (2)
33	Temperature Units	r/w	Value	INTEGER (2)
34	Max Process Temperature	r/w	Value	FLOAT (2)
35	Min Process Temperature	r/w	Value	FLOAT (2)
36	Temperature Source	r/w	Value	INTEGER (1)

Relative Index	Name	Access Structure	Type (cont'd)
37	Fixed Temperature	r/w	Value FLOAT (2)
53	SV3	r/w	Value FLOAT (2)
		r/w	Status UNSIGNED_INTEGER (1)
54	SV3 Units	r/w	Value UNSIGNED_INTEGER (2)
65	Basic setup	r/w	Transducer INTEGER (2)
			Algorithm INTEGER (1)
			Response Rate INTEGER (1)
66	Echo	r/w	Echo Lock INTEGER (1)
			Echo Marker UNSIGNED_INTEGER (1)
67	TVT Hover Level	r/w	INTEGER (1)
68	Confidence Threshold	r/w	Threshold Long UNSIGNED_INTEGER (1)
			Threshold Short UNSIGNED_INTEGER (1)
69	Echo Information	r	Echo Confidence Long UNSIGNED_INTEGER (1)
			Echo Strength UNSIGNED_INTEGER (1)
			Echo Confidence Short UNSIGNED_INTEGER (1)
70		r	Noise Average INTEGER (1)
			Peak Noise INTEGER (1)
			Min Noise INTEGER (1)
72	LOE Timeout	r/w	FLOAT (2)
73	Rate Limits	r/w	Fill Rate Limit FLOAT (2)
			Empty Rate Limit FLOAT (2)
74	Reserved	r	
75	Reserved	r/w	FLOAT (2)
76	Simulation	r/w	Simulation Value FLOAT (2)
			Ramp Start FLOAT (2)
			Ramp End FLOAT (2)
			Ramp Number of Steps UNSIGNED_INTEGER (2)
			Ramp Step Length UNSIGNED_INTEGER (2)
77	Auto TVT	r/w	Simulation INTEGER (1)
			Mode INTEGER (1)
78	Reserved	r	Range FLOAT (2)
			FLOAT (2)
79	Number of shots	r/w	Long shots INTEGER (1)
			Short shots INTEGER (1)
80	Reserved	r/w	INTEGER (1)

Relative Index	Name	Access	Structure	Type (cont'd)
81	Breakout point 1	r/w	Level 1	FLOAT (2)
			Volume 1	FLOAT (2)
82	Breakout point 2	r/w	Level 2	FLOAT (2)
			Volume 2	FLOAT (2)
83	Breakout point 3	r/w	Level 3	FLOAT (2)
			Volume 3	FLOAT (2)
84	Breakout point 4	r/w	Level 4	FLOAT (2)
			Volume 4	FLOAT (2)
85	Breakout point 5	r/w	Level 5	FLOAT (2)
			Volume 5	FLOAT (2)
86	Breakout point 6	r/w	Level 6	FLOAT (2)
			Volume 6	FLOAT (2)
87	Breakout point 7	r/w	Level 7	FLOAT (2)
			Volume 7	FLOAT (2)
88	Breakout point 8	r/w	Level 8	FLOAT (2)
			Volume 8	FLOAT (2)
89	Breakout point 9	r/w	Level 9	FLOAT (2)
			Volume 9	FLOAT (2)
90	Breakout point 10	r/w	Level 10	FLOAT (2)
			Volume 10	FLOAT (2)
91	Breakout point 11	r/w	Level 11	FLOAT (2)
			Volume 11	FLOAT (2)
92	Profile setup	r	DB Start y	INTEGER (1)
		r	DB End y	INTEGER (1)
		r	X Length	INTEGER (1)
		r	Distance	FLOAT (2)
		r	End x	FLOAT (2)
		r	Step x	FLOAT (2)
		r	Meas x	FLOAT (2)
		r	Step x TVT	FLOAT (2)
		r	Echo Marker	UNSIGNED_INTEGER
		93	Profile data part 1	r
94	Profile data part 2	r	Value	byte array
95	Profile data part 3	r	Value	byte array

Relative Index	Name	Access	Structure	Type (cont'd)
96	Profile data part 4	r	Value	byte array
97	Profile data part 5	r	Value	byte array
98	Profile data part 6	r	Value	byte array
99	TVT data part 1	r	Value	byte array
100	TVT data part 2	r	Value	byte array
130	Sound Velocity	r		FLOAT (2)
131	Sound Velocity at 20 °C	r/w		FLOAT (2)
132	Tank shape	r/w	Dim A	FLOAT (2)
			Dim L	FLOAT (2)
133	TVT Shaper Mode	r/w		INTEGER (1)
134	Shaper Array	r/w	Point 1	INTEGER (1)
			Point 2	INTEGER (1)
			Point 3	INTEGER (1)
			Point 4	INTEGER (1)
			Point 5	INTEGER (1)
			Point 6	INTEGER (1)
			Point 7	INTEGER (1)
			Point 8	INTEGER (1)
			Point 9	INTEGER (1)
			Point 10	INTEGER (1)
			Point 11	INTEGER (1)
			Point 12	INTEGER (1)
			Point 13	INTEGER (1)
			Point 14	INTEGER (1)
			Point 15	INTEGER (1)
			Point 16	INTEGER (1)
			Point 17	INTEGER (1)
			Point 18	INTEGER (1)
			Point 19	INTEGER (1)
			Point 20	INTEGER (1)
			Point 21	INTEGER (1)

Relative Index	Name	Access Structure	Type (cont'd)	
134 (cont'd)	Shaper Array(cont'd)	r/w (cont'd)	Point 22	INTEGER (1)
			Point 23	INTEGER (1)
			Point 24	INTEGER (1)
			Point 25	INTEGER (1)
			Point 26	INTEGER (1)
			Point 27	INTEGER (1)
			Point 28	INTEGER (1)
			Point 29	INTEGER (1)
			Point 30	INTEGER (1)
			Point 31	INTEGER (1)
			Point 32	INTEGER (1)
			Point 33	INTEGER (1)
			Point 34	INTEGER (1)
			Point 35	INTEGER (1)
			Point 36	INTEGER (1)
			Point 37	INTEGER (1)
			Point 38	INTEGER (1)
			Point 39	INTEGER (1)
			Point 40	INTEGER (1)
			135	Lock Counters
Sampling Up	UNSIGNED_INTEGER (1)			
136	Lock Window	r/w	Value	FLOAT (2)
137	Reserved			
139	Measuring Range	r/w	Far Range	FLOAT (2)
			Near Range	FLOAT (2)
140	Offset		Offset Calibration	FLOAT (2)
			Offset Cal Status	INTEGER (1)
141	Calibration information		Sound Velocity Calibration	FLOAT (2)
			Velocity Cal Status	INTEGER (1)
142	Temperatures		Internal Temperature	FLOAT (2)
			Transducer Temperature	FLOAT (2)
143	Substance		Value	INTEGER (1)
144	TVT Type		Value	INTEGER (1)
153	Sensor Life		Remaining Sensor Lifetime	UNSIGNED_INTEGER (4)
			Status	BIT_ENUMERATED (1)
			Maintenance ack	BIT_ENUMERATED (1)

Relative Index	Name	Access Structure	Type (cont'd)	
154	Device Lifetime		Maintenance Required Limit	UNSIGNED_INTEGER (4)
			Maintenance Demanded Limit	UNSIGNED_INTEGER (4)
			Maintenance Alert Activation	BIT_ENUMERATED (1)
155	Sensor Life		Total Expected Sensor Life	UNSIGNED_INTEGER (4)
			Total Sensor Operating Time	UNSIGNED_INTEGER (4)
			Lifetime maintenance ack	INTEGER (1)
156	Time Elapsed Since Last Service		Value	UNSIGNED_INTEGER (4)
157	Status		Status	BIT_ENUMERATED (1)
			Service maintenance ack	BIT_ENUMERATED (1)
158	Calibration Interval		Maintenance Required Limit	UNSIGNED_INTEGER (4)
			Maintenance Demanded Limit	UNSIGNED_INTEGER (4)
			Maintenance Alert Activation	INTEGER (1)
159	Service Interval		Total Service Interval	UNSIGNED_INTEGER (4)
			Service ack	INTEGER (1)

Appendix H: Parameter Descriptions

SITRANS Probe LU (PROFIBUS PA): parameter menus

The parameters are grouped in menus according to function. Submenus, arranged on four levels, give access to associated features and options.

Some menus are accessible in PDM only via pull-down menus: in those cases, directions are given beside the individual parameter.

Not all menus are accessible via the handheld programmer. Menus that are accessible via the handheld programmer are preceded by a number (applicable only to the handheld programmer).

Notes:

- For Quick Access to parameters via the handheld programmer, press the mode key to activate PROGRAM mode, then key in the menu number. (For more details, see *The handheld programmer* on page 18.)
- Values shown in the tables below can be entered via the handheld programmer.
- Default values are indicated by an asterisk (*) in the tables, unless explicitly stated.

1. Identification

Operation Unit

Tag

Text that can be used in any way, for example as a unique label for a field device in the plant.

Description

Text that is associated with the Field Device. This text can be used by the user in any way. There is no specific recommended use.

Message

Text that is associated with the Field Device. This text can be used by the user in any way. There is no specific recommended use.

1.2. Configuration

1.2.1. Device Address (default 126)

The unique address of the device on the network (also called PROFIBUS address).

Values	0 - 126
---------------	----------------

Open the menu **Device – Set Address**.

1.2.2. Remote Lockout

Use the handheld programmer to enable or disable programming via the network and PDM.

Hand programmer values	0	*	Unlocked
	1		Locked

1.2.3. Factory Reset

Note: Following a Master Reset, complete reprogramming is required.

Hand programmer values	1	Reset all parameters (except PROFIBUS address) to PROFIBUS PA profile default values
	2506	Warm Start: restart the device (this option is rarely used)
	2712	Reset PROFIBUS address to 126
	32768	Reset to manufacturer's default values (factory settings)

Open the menu **Device – Master Reset** and select one of the four options.

1.2.4. Reset Fault

Resets the Fault message after an active fault has occurred and been corrected. A manual reset is required only for the following faults:

Hand programmer values	12	Internal temperature high
		Transducer temperature high
		Transducer temperature low

Open the menu **View – Clear Faults**, and select the fault in question from the pull-down menu for Extended Diagnostics.

(To reset via the handheld programmer, key in the value of the fault code in question.)

1.2.5. Menu Timeout (default 120 s)

Determines the length of time (in seconds) the device will stay in PROGRAM mode without any key presses occurring.

1.3. Device

Manufacturer

References a specific manufacturer, usually the name of the company responsible for the manufacture of this Field Device.

Product designation

Uniquely identifies the Field Device when combined with the Manufacturer Identification and Device Type. This variable cannot be modified by the Host user.

Device Serial Num

Uniquely identifies the Field Device. This variable cannot be modified by the Host.

Order No.

The order number for this device.

Date of birth

Date of manufacture.

1.3.1. Software Revision

Corresponds to the firmware embedded in the Field Device.

1.3.2. Loader Revision

Corresponds to the firmware used to update the Field Device.

1.3.3. Hardware Revision

Corresponds to the electronics hardware of the Field Device.

Profile Revision

PROFIBUS PA Profile standard that this device conforms to.

Static Revision No.

The revision level of the static data associated with the Physical Block. The Static Revision No. is updated whenever a standard profile configuration parameter is changed.

1.3.4. PROFIBUS Ident Number

Identifies the device on the network. The Ident Number must match that in the GSD file (the GSD file provides information on the device to the master).

Hand programmer values	0		Profile-specific [uses generic GSD for 2 AIFB (ident# = x9701)]
	1	*	Manufacturer-specific (uses SMPI DD and GSD file, which identifies the Probe LU [PROFIBUS PA]).
	128		Profile-specific [uses generic GSD for 1 AIFB (ident# = x9700)]

Installation Date

Date on which the device was installed. The user must enter the date.

Local Operation Enable (default Enabled)

Enables/disables programming the device via the handheld programmer. When disabled, the user still has access to the mode control of the two Analog Input Function Blocks.

Go to **Identification > Device > Local Operation Enable** and select the desired setting.

1.3.5. Write Locking

Prevents any changes to parameters via PDM or the handheld programmer.

Hand programmer values	2457 (unlock value)	*	Off (enables programming)
	any other value		On (disables programming)

Open the menu **Device – Write Locking**, and select On or Off.

1.3.6. Contrast

Allows you to adjust the LCD contrast to compensate for different lighting conditions.

Values	Range: 0 to 10
	Default: 3

Go to **Identification > Device > Contrast**, and enter the desired value. To increase the contrast, enter a higher value.

1.3.7. Language

Selects the language to be used on the LCD.

Hand programmer values	0	*	English
	1		German
	2		French
	3		Spanish

1.4. Statistics

1.4.1. Powered Hours

Number of hours the unit has been powered up since manufacture.

Open menu **View – Wear**.

1.4.2. Poweron Resets

The number of power cycles that have occurred since manufacture.

Open menu **View – Wear**.

1.4.3. Internal Temperature

The internal electronics temperature.

Value (view only)	Degrees C
--------------------------	-----------

Open menu **View – Peak Values**, and select the tab **Temperature**.

1.4.4. Transducer Temperature

The temperature inside the tank (process temperature) registered by the transducer.

Value (view only)	Degrees in Temperature Units
--------------------------	------------------------------

Open menu **View – Display**, and select the tab **Measured Value (Secondary Values)**.

2. Input

Static Revision Number

The revision level of the static data associated with the Transducer Block, updated whenever a standard profile configuration parameter is changed.

Class

Indicates the Level Transducer Block as per PROFIBUS PA Profile specifications.

2.1. Target Mode

Note: If Target Mode has been changed locally and you want to prevent an external process from resetting it back to normal, you should ensure *Remote Lockout* (see page 78) is set to **Locked**.

Visible only via the handheld programmer. Used to request an operating mode from the Transducer Block. (Out-of-service mode is a safety feature, used for service purposes to stop the transducer firing).

Hand programmer values	128		Out of Service (O/S)
	16		Manual Mode (MAN)
	8	*	Automatic Mode (AUTO)

2.2. Reset Filter

Resets the rate filter.

Hand programmer value	1	the sensor value immediately goes to the target distance
------------------------------	----------	--

2.3. Standard Setup

2.3.1. Response Rate

Sets the reaction speed of the device to measurement changes in the target range.

Related parameters	Response Rate		LOETimer ¹ (minutes)	Fill Rate	Empty Rate	Echo Lock ²
Hand programmer values	1	*	slow	100	0.1 m/minute	0.1 m/minute
	2		medium	10	1 m/minute	1 m/minute
	3		fast	1	10 m/minute	10 m/minute
						2 material agitator

Note: Changing Response Rate resets the following parameters: LOE Timer, Fill Rate, Empty Rate, and Echo Lock.

Use a setting just faster than the maximum filling or emptying rate (whichever is greater). Slower settings provide higher accuracy: faster settings allow for more level fluctuation.

2.3.2. Echo Lock

Note: Ensure the agitator is always running while SITRANS Probe LU is monitoring the vessel, to avoid stationary blade detection.

Selects the measurement verification process.

Hand programmer values	0		Off
	1		Maximum Verification
	2	*	Material Agitator
	3		Total Lock
Related parameters	Maximum Fill Rate Maximum Empty Rate Echo Lock Sampling Echo Lock Window Algorithm		

If a material agitator or mixer is used in the monitored vessel, Echo Lock should be set for Maximum Verification or Material Agitator to avoid agitator blade detection.

¹ For more detail, see *LOE Timer* on page 38.

² For more detail, see *Echo Lock* on page 37.

2.3.3. Temperature Source¹

Determines the source of the temperature reading used for calculating speed of sound. There are two options:

Hand programmer values		Fixed Temperature (user-defined value: see below)
	*	Automatic default value (recorded by sensor inside the transducer)

2.3.4. Fixed Temperature¹ (default 20 °C)

Defines the fixed temperature (in degrees C) used for calculating speed of sound (see above).

Values	Range, Degrees C
---------------	------------------

2.3.5. PROFIBUS Current Consumption

Warning: This parameter should be modified only once at installation, to match the design criteria of the network.

Allows you to select the PROFIBUS device current. Higher values allow faster update rates.

Values		Loop current	Update Time²
0	*	12 mA	6.0 s (typical), maximum 16.0 s
1		13 mA	5.0 s (typical), maximum 14.0 s
2		15 mA	3.7 s (typical), maximum 8.0 s
3		20 mA	2.4 s (typical), maximum 4.0 s

Go to **Input > Standard Setup > PROFIBUS Current Consumption**, and enter the value corresponding to the desired device current.

1. This parameter cannot be reset to factory default settings.

2. Temperature dependent: typical values at +20 °C (+68 °F); maximum values at +80 °C (+176 °F).

2.4. Sensor Calibration

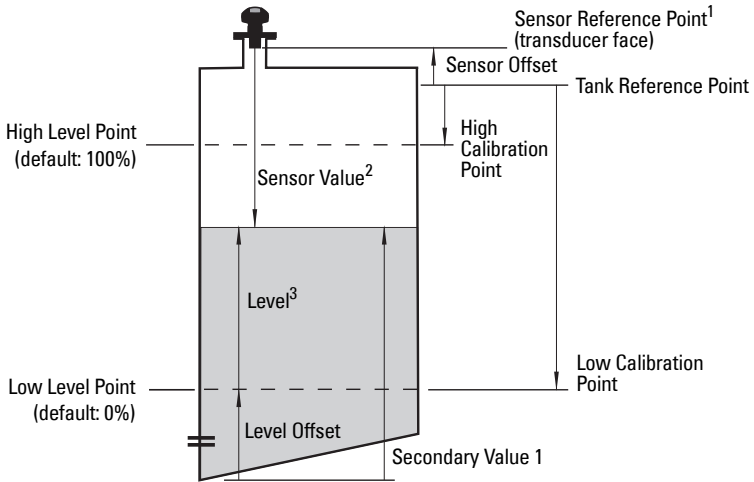

2.4.1. Sensor Units

Whatever units the sensor is measuring in.

2.4.2. Calibration Type

*In **Dry** calibration, the user enters all four calibration values: High and Low Level Points, and High and Low Calibration Points. In **Wet** calibration, the actual material level provides the values for Low Calibration and High Calibration Points. The user enters the corresponding Low and High Level Points.*

Hand programmer values	0	*	Dry calibration (preferred)
	1		Wet calibration

Open the menu **Device – Sensor Calibration**, and click on the button for **Wet** or **Dry** calibration.

1. Sensor Reference Point: the point to which all of the above parameters are referenced, which is the transducer face.
2. Sensor Value: the value produced by the echo processing, which represents the distance from the Sensor Reference Point to the target.
3. Level Value: the level measured in level units.

2.4.3. Low Calibration Pt. (default 6 m)

*Distance from Sensor Reference Point to Low Calibration Point (corresponding to Low Level Point). Unit is defined in Sensor units (open the menu **Device – Sensor Calibration**, then click on **More Information**, to see an illustration.)*

1. Open the menu **Device – Sensor Calibration**, and click on the button for Wet or Dry calibration.
2. Enter the values for Low Calibration Point, Low Calibration Level, High Calibration Point, High Level Point, then click on **Transfer**.

2.4.4. High Calibration Pt. (default 0)

*Distance from Sensor Reference Point to High Calibration Point (corresponding to High Level Point). Unit is defined in Sensor units (open the menu **Device – Sensor Calibration**, then click on **More Information**, to see an illustration.)*

1. Open the menu **Device – Sensor Calibration**, and click on the button for Wet or Dry calibration.
2. Enter the values for Low Calibration Point, Low Calibration Level, High Calibration Point, High Level Point, then click on **Transfer**.

2.4.5. Unit (Level): default %

Selected engineering units for Level (PV).

- Referenced from Low Level Point (plus level offset, if any)
- Can be any linear measurement (commonly selected units shown below)

Hand programmer values	1010		m
	1012		cm
	1013		mm
	1018		ft
	1019		in
	1342	*	%

2.4.6. Low Level Point (default 0)

*The level when the material is at Low Calibration Point. The unit is defined in Level units (open the menu **Device – Sensor Calibration**, then click on **More Information**, to see an illustration.)*

1. Open the menu **Device – Sensor Calibration**, and click on the button for Wet or Dry calibration.
2. Enter the values for Low Calibration Point, Low Calibration Level, High Calibration Point, High Level Point, then click on **Transfer**.

2.4.7. High Level Point (default 100)

*The level when the material is at High Calibration Point. The unit is defined in Level units (open the menu **Device – Sensor Calibration**, then click on **More Information**, to see an illustration.)*

1. Open the menu **Device – Sensor Calibration**, and click on the button for Wet or Dry calibration.
2. Enter the values for Low Calibration Point, Low Calibration Level, High Calibration Point, High Level Point, then click on **Transfer**.

2.4.8. Level Offset (default 0)

A constant offset that is added to Level to form SV1 (Secondary Value 1). The unit is defined in Level units.

Level Offset is used to compensate for specific tank configurations.

2.4.9. Sensor Offset (default 0)

Note: If a velocity calibration is performed after the sensor offset value has been set manually, the sensor offset value will be reset to 0.

The offset from the Sensor's reference point to the tank's reference point. If sensor offset is used, it is a negative value that is subtracted from the values for the high and low calibration points. The unit is defined in Sensor Units.

Compensates, for example if the sensor head is changed.

2.4.A. Temperature Units

Selects the engineering unit to be displayed with the value representing temperature.

Hand programmer values	1034		Degrees K
	1001	*	Degrees C
	1002		Degrees F
	1003		Degrees R

2.5. Measuring Limits

2.5.1. Min. Measured Value

The minimum recorded Sensor value, defined in Sensor units.

Open menu **View – Peak Values**, and click Sensor tab.

2.5.2. Max. Measured Value

The maximum recorded Sensor value, defined in Sensor units.

Open menu **View – Peak Values**, and click Sensor tab

2.5.3. Min. Sensor Value (default 0.25 m)

Defines the minimum usable value for the measuring range (physical limit of the sensor) in Sensor units.

Open menu **View – Peak Values** and select the tab **AIFB1** or **AIFB2**. If necessary, click on the reset button, and download to the device.

2.5.4. Max. Sensor Value (6 m or 12 m, depending on unit)

Defines the maximum usable value for the measuring range (physical limit of the sensor) in Sensor units.

Open menu **View – Peak Values** and select the tab **AIFB1** or **AIFB2**. If necessary, click on the reset button, and download to the device.

2.5.5. Process Temperature Min.

The minimum recorded temperature of the internal electronics.

Open menu **View – Peak Values** and select the tab **Temperature**. If necessary, click on the reset button, and download to the device.

2.5.6. Process Temperature Max.

The maximum recorded temperature of the internal electronics.

Open menu **View – Peak Values** and select the tab **Temperature**. If necessary, click on the **Reset** button, and download to the device.

2.6. Linearization

Carries out a volume conversion from a level value.

2.6.1. PV (volume/level) Units (default %)

Select units for either volume or level.

Hand programmer values	1010		m
	1012		cm
	1012		mm
	1018		ft
	1019		in
	1342	*	%
	1034		m ³
	1038		L
	1042		ft ³
	1043		in ³

2.6.2. Linearization Type/Tank Shape (default None)

*Defines the tank shape and allows the Probe LU to calculate volume instead of level. If **None** is selected, no volume conversion is performed. Select the tank shape matching the monitored tank or reservoir (see table on next page).*

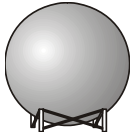
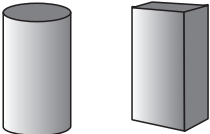
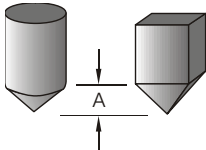
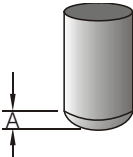
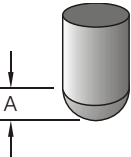
Enter ¹	Tank Shape	Description	Also required
*	----	None (no volume calculation required)	N/A
20		flat end horizontal cylinder	linearization volume
21		sphere	linearization volume
240		upright, linear (flat bottom)	linearization volume
241		conical or pyramidal bottom	linearization volume, dimension A
242		parabolic bottom	linearization volume, dimension A
243		half-sphere bottom	linearization volume, dimension A

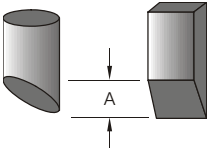
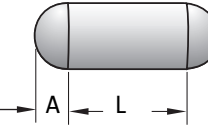
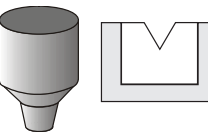
Enter ¹	Tank Shape (cont'd)	Description	Also required
244		flat sloped bottom	linearization volume, dimension A
245		parabolic end horizontal cylinder	linearization volume, dimension A, dimension L
247		universal linear (level/volume/flow breakpoints)	linearization volume (flow), level (head) breakpoints, volume (flow) breakpoints

1. Enter handheld programmer value.

2.6.3. Linearization Volume (default 100.0)

The maximum volume of the tank. Units are defined in Primary Value units. Any volumetric units can be chosen, because the volume calculation is based on the maximum volume, and scaled according to the vessel shape selected. If no vessel shape is entered, the default is 100, and the reading will be a percentage value.

Hand programmer values	Range: 0.0000 to 99999
Related Parameters	Low Calibration Point High Calibration Point

For readings in volumetric units instead of percentage values, enter the vessel volume corresponding to High Calibration Point.

2.6.4. Dimension A (default 0.0)

The height of the vessel bottom (in level units) when the bottom is conical, pyramidal, parabolic, spherical, flat sloped, cylindrical, or spherical. See page 88 for an illustration.

Hand programmer values	Range: 0.0000 to 99999 in units (P005)
Related Parameters	Tank Shape

1. Go to **Input > Sensor Calibration > Unit (level)** and select desired level units.
2. Key in the height of the vessel bottom in level units.

2.6.5. Dimension L (default 0.0)

Length of the cylindrical section of a horizontal parabolic end tank, in level units. See page 89 for an illustration.

Hand programmer values	Range: 0.0000 to 99999 in units (P005)
Related Parameters	Tank Shape

1. Go to **Input > Sensor Calibration > Unit (level)** and select desired level units.
2. Key in the height of the vessel bottom in level units.

2.7. Detailed Setup

2.7.1. Failsafe

2.7.1.1. LOE (Loss of Echo) Timer (default 10)

Amount of time, in minutes, that a Loss of Echo must persist, before the device goes into Failsafe mode. See page 38 for more details.

Hand programmer values	Range: 0.00 to 720 (minutes)
-------------------------------	-------------------------------------

2.7.2. Volume

When the vessel shape is too complex for any of the preconfigured shapes, you can define the shape as a series of segments. First assign a value to each level breakpoint, then assign a corresponding value to each volume breakpoint. (Volume values can be percent or volumetric; level values can be percent or linear.)

Level Values	Range: 0.0000 to 99999 (% , ft, m, in, cm, mm, gal, L, imp. gal: see PDM for more)
	Default: 0.0
Volume Values	Range: 0.0000 to 99999 (% or volumetric units)
	Default: 0.0

Enter up to 32 level breakpoints, where the corresponding volume is known. The values corresponding to 100% and 0% levels must be entered. The breakpoints can be ordered from top to bottom, or the reverse. Breakpoints are normalized to 0.

Entering breakpoints in PDM:

- First go to **Linearization > PV (volume/level) units**, and select the desired volume units.
- The default for level values is percent: if you want to select units instead, go to **Input > Sensor Calibration > Unit (level)**, and select the desired unit.
- Go to **> Linearization/Tank Shape**, and select **Linearization table** option.
- Go to **Detailed Setup > Volume**.
- In **Level 1**, enter a level value for breakpoint 1 (point 1 should always be 0).
- In **Volume 1**, enter the corresponding volume value for breakpoint 1 (point 1 should always be 0).
- Repeat steps **c** and **d** until values have been entered for all the required breakpoints. The highest level and volume values should correspond to the maximum volume setting or 2.4.7 (High Level Pt)

Note: Changing 2.4.7 (High Level Point) after programming the level/volume points will change the level setting and proportionally increase or decrease the volume values at the new level setting.

Example:

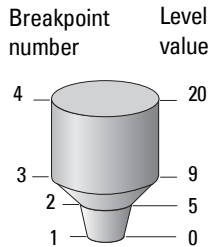

Breakpoint Number	Level value (m)	Volume value (l)
1	0	0
2	5	500
3	9	3000
4	20	8000

Note: Breakpoint values are for example purposes only.

Flow

The level and volume breakpoints can be also be used to calculate head level and flow rate in an open channel device. (For more information please see Open Channel Monitoring (OCM) on page 41.)

Use the level breakpoints to enter head level values, and the volume breakpoints to enter flow volumes. Each segment defined by a head breakpoint requires a corresponding flow value, so that SITRANS Probe LU can make the head-to-flow calculations.

Use the Flow table associated with your open channel device (Parshall flume, v-notch weir, or other measuring device) to calculate the flow rate for each breakpoint.

Entering head level and flow breakpoints in PDM:

- a. First go to **Linearization > PV (volume/level) units**, and select the desired units to be used for flow.
- b. The default for head level values is percent; if you want to select units instead, go to **Input > Sensor Calibration > Unit (level)**, and select the desired unit.
- c. Go to **> Linearization/Tank Shape**, and select **Linearization table** option.
- d. Go to **Detailed Setup > Volume**.
- e. In **Level 1**, enter a head level value for breakpoint 1 (point 1 should always be 0).
- f. In **Volume 1**, enter the corresponding flow value for breakpoint 1 (point 1 should always be 0).
- g. Repeat steps **c** and **d**, until values have been entered for all the required breakpoints. The highest head and flow level should correspond to the maximum head setting or 2.4.7 (High Level Pt).

Note: Changing 2.4.7 (High Level Point) after programming the head/flow points will change the head setting and proportionally increase or decrease the flow values at the new head setting.

Example: v-notch weir:

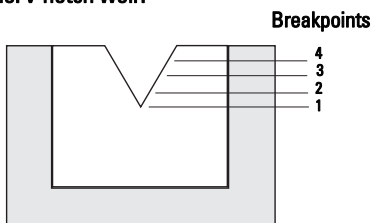

Break-point	Head (level)	Flow (volume)
4	0.4 m	113.5
3	0.3 m	55.3
2	0.2 m	20.07
1	0 m	0

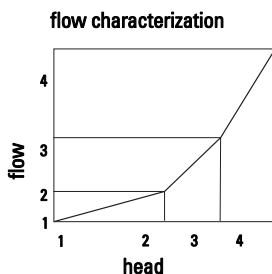

Note: Illustrated breakpoint values are for example purposes only.

2.7.3. Echo select

2.7.3.1. Algorithm

Selects the algorithm to be applied to the echo profile to extract the true echo.

Hand programmer values	12		tF	
	3		L	Largest echo (reserved for SMPI service personnel)
	4		F	First echo
	8	*	bLF	best of Largest or First echo (reserved for SMPI service personnel)

2.7.3.2. Threshold Short (default 10)

Note: The Threshold parameters are for use by authorized Siemens Service personnel or technicians familiar with Siemens echo processing techniques.

Sets the minimum Short Shot echo confidence that the echo must meet in order to be considered a valid echo.

Hand programmer values	Range: 0 to 99
Related Parameters	LOE Timer

2.7.3.3. Threshold Long (default 5)

Sets the minimum Long Shot echo confidence that the echo must meet in order to be considered a valid echo.

Hand programmer values	Range: 0 to 99
Related Parameters	LOE Timer

2.7.3.4. Echo Marker (default 50)

The point on the selected echo from which the measured value is taken.

2.7.3.5. Short Shots (default 2)

The number of Short Shots transmitted and averaged per measurement cycle.

2.7.3.6. Long Shots (default 2)

The number of Long Shots transmitted and averaged per measurement cycle.

2.7.3.8. Sound Velocity at 20 °C (default 344.13)

Sound velocity through the medium at 20 °C. (Sound velocity in air is 344.1 m/s or 1129 ft/s.)

2.7.3.9. Offset and Velocity calibration

1. Offset calibration

You can specify a fixed value to apply to all measurements. Use this function if the reported level is consistently high or low by a fixed amount (stored in Sensor Offset).

Open menu **Device – Offset and Velocity Calibration**, select the option to change calibration, select the calibration type, then enter new calibration value.

2. Sound Velocity calibration

Note: If a velocity calibration is performed after the sensor offset value has been set manually, the sensor offset value will be reset to 0.

Used to calculate sound velocity when either the acoustic beam environment is other than air or unknown, or the reading accuracy is acceptable only at higher material level.

For best results, calibrate with the level at a known value close to empty, and manually determine the actual distance from sensor to material level.

Open menu **Device – Offset and Velocity Calibration**, select the option to change calibration, select the calibration type, then enter new calibration value.

2.7.4. Echo Sampling

Note: The Echo Sampling parameters are for use by authorized Siemens Service personnel or technicians familiar with Siemens echo processing techniques.

2.7.4.1. Sampling up¹ (default 5)

Once echo is outside the window, a specified number of consecutive echoes must appear above the echo locked onto, before measurement is accepted as valid.

¹ This parameter is for use only by Siemens service technicians.

2.7.4.2. Sampling down¹ (default 2)

Once echo is outside the window, a specified number of consecutive echoes must appear below the echo locked onto, before measurement is accepted as valid.

2.7.4.3. Window¹ (default 0)

*A "distance window" centered on the echo, used to derive the reading. When a new measurement is in the window, the window is re-centered and the reading is calculated (see **Display before Auto False Echo Suppression** on page 98 for an illustration).*

When the value is 0, the window is automatically calculated after each measurement.

- For slower Measurement Response values, the window is narrow.
- For faster Measurement Response values, the window becomes progressively wider.

Note: The echo lock window is stored as standard sample, but displayed in the engineering units selected to display level. Any value entered for the echo lock window will be rounded to the nearest sample.

2.7.4.4. Window Used¹

*The actual size of the window (whereas **Window** refers to the designed size of the window).*

2.7.5. Range

2.7.5.1. Near Range (LOW RANGE): (default value 0.25 m)

*Minimum distance from the reference point² beyond which an echo should be considered valid. (This is sometimes referred to as **Blanking**.)*

Hand programmer values	Range: 0 to 20 m
-------------------------------	------------------

2.7.5.2. Far Range (HI RANGE): (default 6 m or 12 m, depending on unit)

Note: Far Range can extend beyond the bottom of the tank.

Maximum distance from the reference point², within which an echo should be considered valid.

Hand programmer values	Range: 0 to 20 m
-------------------------------	------------------

¹ This parameter is for use only by Siemens service technicians.

² The transducer face.

2.7.6. Echo Quality

2.7.6.1. Confidence Short

Short shot confidence value displays the echo confidence of the measurements echo from the last short shot. Echo confidence measures echo reliability. Threshold Short defines the minimum criterion for short shot echo confidence.

Values (view only)	0 to 99	
	----	Shot not used
Related Parameters	Threshold Short	

Open the menu **View – Profile**.

2.7.6.2. Confidence Long

Long shot confidence value displays the echo confidence of the measurements echo from the last long shot. Echo confidence measures echo reliability. Threshold Long defines the minimum criterion for long shot echo confidence.

Values (view only)	0 to 99	
	----	Shot not used
Related Parameters	Threshold Long	

Open the menu **View – Profile**.

2.7.6.3. Echo Strength

Displays the amplitude (in dB above 1 μ V rms) of the echo selected as the measurement echo.

Values (view only)	-20 to 112
---------------------------	-------------------

Open the menu **View – Profile**.

2.7.7. TVT setup

First SITRANS Probe LU learns the echo profile. Then the learned profile, or part of the learned profile, is used to screen out false echoes.

2.7.7.1. TVT Hover Level¹ (default 33%)

Defines in percent how high the TVT (Time Varying Threshold) curve is placed above the echo profile, with respect to largest echo. When SITRANS Probe LU is located in the center of the vessel, lower this parameter to prevent multiple echo detections.

Values	Range: 0 to 100%
---------------	--------------------------------

2.7.7.2. TVT Type

Selects the TVT curve to be used.

Hand programmer values	1	*	TVT short curve
	2		TVT short flat
	3		TVT long flat
	4		TVT long smooth flat
	5		TVT long smooth
	6		TVT slopes

2.7.7.7. Auto False Echo Suppression

Enables a 'learned' TVT curve to be used in place of the default TVT curve.

Use this feature to ignore false echoes on the echo profile. Set Range (Auto False Echo Suppression Distance) first.

Hand programmer values	0	*	Off
	1		On
	2		Learn the TVT curve

- Rotate the instrument for best signal (lower false-echo amplitude).
- Go to Range, and set the value (see page 98).
- Open the menu **Device – Auto False Echo Suppression** and select the option to change it.
- Select **Learn**. The device will automatically revert to On (Use Learned TVT) after a few seconds.

¹ For an illustration, see *Display before Auto False Echo Suppression* and *Display after Auto False Echo Suppression*, on page 98.

2.7.7.8. Range (Auto False Echo Suppression)¹: (default 1)

Defines the endpoint of the Learned TVT distance.

- Go to **Input > Detailed Setup > TVT setup > Distance**.
- Determine the actual distance from the reference point (transducer face) to the material surface.
- Subtract 0.5 m (20") from this distance, and enter the result.

Display before Auto False Echo Suppression

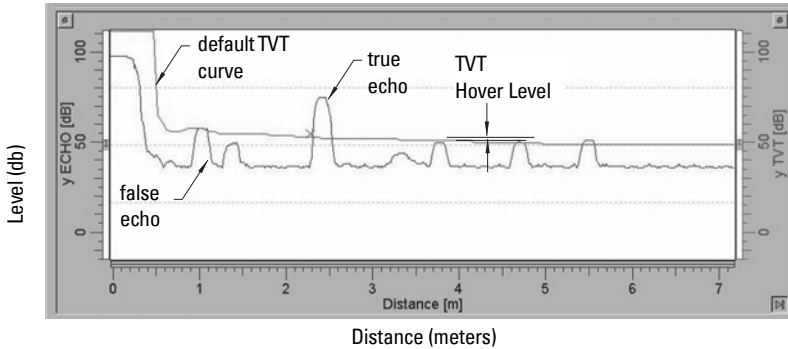

Display after Auto False Echo Suppression

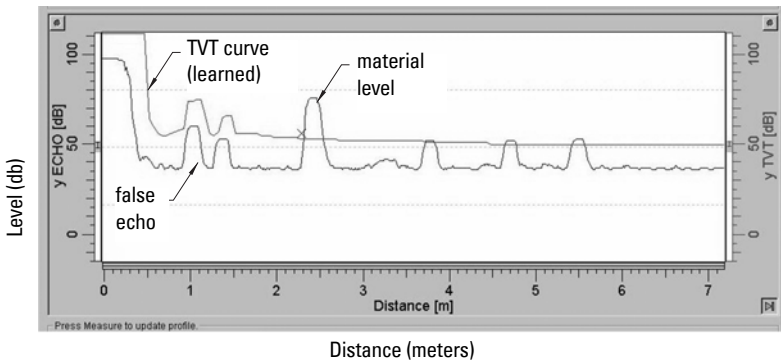

2.7.7.9. Shaper Mode (default Off)

Turns TVT Shaper on or off. (For use only by Siemens personnel.)

¹ This parameter cannot be reset to the factory default.

2.7.8. TVT shaper

A breakpoint on the TVT curve, normalized to 0.

- 2.7.8.1. Shaper A (1-9)
- 2.7.8.2. Shaper B (10-18)
- 2.7.8.3. Shaper C (19-27)
- 2.7.8.4. Shaper D (28-36)
- 2.7.8.5. Shaper E (37 - 40)

2.7.9. Rate

2.7.9.1. Fill Rate (default 0.1)

Defines the maximum rate at which the reported sensor value is allowed to increase. Allows you to further adjust the Probe LU response to increases in the actual material level (or an advance to a higher Failsafe Material Level, P071). Fill Rate is automatically updated whenever Response Rate is altered.

Values	Range: 0.0000 to 99999 m/min.
Altered by	Response Rate
Related	Unit (Level) High Level Point

Enter a value slightly greater than the maximum vessel-filling rate, in Sensor Units per minute.

Hand Programmer Value		Meters/Minute
1	*	0.1
2		1
3		10

2.7.9.2. Empty rate (default 0.1)

Defines the maximum rate at which the reported sensor value is allowed to decrease. Adjusts the Probe LU response to decreases in the actual material level. Empty Rate is automatically updated whenever Response Rate is altered.

Values	Range: 0.0000 to 99999 m/min.
Altered by	Response Rate
Related	Units (Level) High Level Point

Enter a value slightly greater than the vessel's maximum emptying rate, in Sensor Units per minute.

Hand Programmer Value		Meters/Minute
1	*	0.1
2		1
3		10

2.7.A. Transducer Block (TB) Values (for diagnostic purposes)

2.7.A.1. PV (Primary Value)

The value for level, or volume (if volume conversion is selected).

Open the menu **View – Display**, and select the tab **Measure Valued (Secondary Values)**.

2.7.A.2. SV1 (Secondary Value 1)

The value for level.

Open the menu **View – Display**, and select the tab **Measure Valued (Secondary Values)**.

2.7.A.3. SV2 (Secondary Value 2)

The value for distance.

Open the menu **View – Display**, and select the tab **Measure Valued (Secondary Values)**.

3. Output

3.1. AIFB1

Static Revision No.

The revision level of the static data associated with Analog Input Function Block 1. The Static Revision No. is updated whenever a standard profile configuration parameter is changed.

3.1.1. Target Mode

Used to request an operating mode from the Function Block. (Out-of-service mode is a safety feature, used for service purposes to stop the transducer firing).

Values	128		Out of Service (O/S)
	16		Manual Mode (MAN)
	8	*	Automatic Mode (AUTO)

Open the menu **Device – Simulation**, go to **Function Block – AIFB1 or 2**, click on the tab **Simulation Output**, and select a target mode. Then click on the tab **Simulation (Measured Value)**, and enable or disable **Simulation**.

Note: If Target Mode has been changed locally and you want to prevent an external process from resetting it back to normal, you should ensure *Remote Lockout* (see page 78) is set to **Locked**.

3.1.2. Unit (default %)

Defines the engineering unit to be displayed with the output value.

3.1.3. Filter Time Constant (default 10)

Contains the time constant for the damping filter. The engineering unit is always in seconds. (This is an exponential filter: when a change occurs at the input, the output will be at 63.2% of the change in one time constant, and will be at full change after 5 time constants.)

3.1.4. Function (default PV)

Used to select between the different Level Transducer Block outputs (Volume/Level, Level, Distance in Sensor units, Distance in Level units).

3.1.5. Batch Information

These 4 parameters are intended to be used in Batch Applications conforming to IEC 61512 Part 1 (ISA S88). Other applications do not require these values, which are only stored in the Function Block.

3.1.5.1. Batch ID (default 0)

Identifies a certain batch to allow assignment of equipment-related information (for example faults, alarms) to the batch.

3.1.5.2. Batch Unit (default 0)

Identifies the active Control Recipe Unit Procedure or the related Unit (for example, reactor, centrifuge, drier).

3.1.5.3. Batch operation (default 0)

Identifies the active Control Recipe Operation.

3.1.5.4. Batch Phase (default 0)

Identifies the active Control Recipe Phase.

3.1.6. Process Value Scale

3.1.6.1. Lower Value (default 0)

Defines the operational lower range value of the input value (Process Value Scale) in engineering units. Process Value Scale normalizes the input value to a customer-defined range.

3.1.6.2. Upper Value (default 100)

Defines the operational upper range value of the input value (Process Value Scale) in engineering units. Process Value Scale normalizes the input value to a customer-defined range.

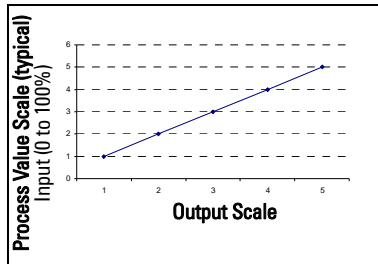

Out (AIFB1 or AIFB2 Out)

3.1.7. Output Scale

Scales the Process Variable. The function block parameter OUT SCALE contains the values of the lower limit and upper limit effective range.

3.1.7.1. Lower Value (default 0)

Defines the operational lower range value of the output value in engineering units.

3.1.7.2. Upper Value (default 100)

Defines the operational upper range value of the output value in engineering units.

3.1.8. Output Limits

3.1.8.1. Lower Limit Alarm

The setting for the lower alarm limit in engineering units.

3.1.8.2. Lower Limit Warning

The setting for the lower warning limit in engineering units.

3.1.8.3. Upper Limit Warning

The setting for the upper warning limit in engineering units.

3.1.8.4. Upper Limit Alarm

The setting for the upper alarm limit in engineering units

3.1.8.5. Limit Hysteresis (default 0.50%)

Defines the value of the hysteresis used for all warnings and alarms. Hysteresis is used to adjust the sensitivity of the trigger for alarm messages, to compensate when a process variable fluctuates around the same value as a limit. A high level alarm occurs when a value exceeds an upper limit. The alarm's status remains true until the value drops below the limit minus the alarm hysteresis. The directions are reversed for low limit detection.

Enter a value for the hysteresis here, to be used for all warnings and alarms. The units are the same as the output value scale.

3.1.8.6. Minimum Output Value

The minimum peak indicator for the AIFB output values.

3.1.8.7. Maximum Output Value

The maximum peak indicator for the AIFB output values.

3.1.9. Failsafe Mode

3.1.9.1. Failsafe Mode

Defines the reaction of the device if a Failsafe condition is detected, or if the device has been put into Failsafe mode using Simulation. You can select one of three options for the material level to be reported when the LOE timer expires.

Hand Programmer Values		Material level to be reported
0		Default value used as output value.
1	*	Store last valid output value.
2		Calculated output value is incorrect.

3.1.9.2. Failsafe Value (default 0)

(Accessible in PDM only after 0 is selected in Failsafe Mode).

*A user-defined value to be output by the Function Block if Failsafe mode is set to: **Default value is used as output value.***

3.1.A. Human Interface

3.1.A.1. Decimal Point (default 2)

The number of digits to display after the decimal point. (The LCD is limited to displaying three decimal places.)

Out unit text

If the code list does not contain a desired unit for the OUT parameter, (see General Requirement) you can write the specific text in this parameter.

3.2. AIFB2

(See AIFB1: the parameters for AIFB2 are identical.)

4. Certificates and Approvals

4.1. Device Certification

5. Maintenance settings

5.1. Remaining Device Lifetime

- 5.1.1. Total Device Operating Time
- 5.1.2. Remaining Device Lifetime
- 5.1.3. Maintenance Required Limit
- 5.1.4. Maintenance Demanded Limit
- 5.1.5. Maintenance Alert Activation
- 5.1.6. Total Expected Device Life
- 5.1.7. Units
- 5.1.8. Maintenance Status
- 5.1.9. Acknowledge Status
- 5.1.10. Acknowledge

5.2. Remaining Sensor Lifetime

- 5.2.1. Total Sensor Operating Time
- 5.2.2. Remaining Sensor Lifetime
- 5.2.3. Maintenance Required Limit
- 5.2.4. Maintenance Demanded Limit
- 5.2.5. Maintenance Alert Activation
- 5.2.6. Total Expected Sensor Life
- 5.2.7. Units
- 5.2.8. Maintenance Status
- 5.2.9. Acknowledge Status
- 5.2.10. Acknowledge

5.3. Service Interval

- 5.3.1. Time Elapsed Since Last Service
- 5.3.2. Maintenance Required Limit
- 5.3.3. Maintenance Demanded Limit
- 5.3.4. Maintenance Alert Activation
- 5.3.5. Total Service Interval
- 5.3.6. Units
- 5.3.7. Maintenance Status
- 5.3.8. Acknowledge Status
- 5.3.9. Acknowledge

5.4. Calibration Interval

- 5.4.1. Time Elapsed Since Last Calibration
- 5.4.2. Maintenance Required Limit
- 5.4.3. Maintenance Demanded Limit
- 5.4.4. Maintenance Alert Activation
- 5.4.5. Total Calibration Interval
- 5.4.6. Units
- 5.4.7. Maintenance Status
- 5.4.8. Acknowledge Status
- 5.4.9. Acknowledge

6. Condensed Status Setup

6.1. Condensed Status Mode

Event Index

Event Status

Event Diagnosis

- 6.1.1. Loss of Echo S0 (Status; Diagnosis)
- 6.1.2. Cable Fault S1 (Status; Diagnosis)
- 6.1.3. No Tech Power S2 (Status; Diagnosis)
- 6.1.4. Device Lifetime Maintenance Required Limit S3 (Status; Diagnosis)
- 6.1.5. Device Lifetime Maintenance Demanded Limit S4 (Status; Diagnosis)
- 6.1.7. Sensor Lifetime Maintenance Required Limit S6 (Status; Diagnosis)
- 6.1.8. Sensor Lifetime Maintenance Demanded Limit S7 (Status; Diagnosis)
- 6.1.9. Device Service Maintenance Required Limit S8 (Status; Diagnosis)
- 6.1.10. Device Service Maintenance Demanded Limit S9 (Status; Diagnosis)
- 6.1.11. LTB Scale S10 (Status; Diagnosis)
- 6.1.12. Internal Temp Sensor S11 (Status; Diagnosis)
- 6.1.13. Internal Temp High S12 (Status; Diagnosis)
- 6.1.15. AIFB1 PV Range S14 (Status; Diagnosis)
- 6.1.16. AIFB2 PV Range S15 (Status; Diagnosis)
- 6.1.18. Calibration Schedule Maintenance Required Limit S17 (Status; Diagnosis)
- 6.1.19. Calibration Schedule Maintenance Demanded Limit S18 (Status; Diagnosis)
- 6.1.29. Memory RAM S28 (Status; Diagnosis)
- 6.1.30. Memory EEPROM S29 (Status; Diagnosis)
- 6.1.31. Memory EEPROM Flags S30 (Status; Diagnosis)
- 6.1.32. Memory Flash S31 (Status; Diagnosis)
- 6.1.33. Ident Violation S32 (Status; Diagnosis)
- 6.1.34. Internal Temperature Calibration S33 (Status; Diagnosis)

(continued on next page)

- 6.1.35. Velocity Calibration S34 (Status; Diagnosis)
- 6.1.36. Receiver Init Calibration S35 (Status; Diagnosis)
- 6.1.37. Receiver Calibration S36 (Status; Diagnosis)
- 6.1.38. Tech Module Hardware S37 (Status; Diagnosis)
- 6.1.39. Tech Module Ramp S38 (Status; Diagnosis)
- 6.1.40. Transducer Temperature Sensor S39 (Status; Diagnosis)
- 6.1.41. Transducer Temperature High S40 (Status; Diagnosis)
- 6.1.42. Transducer Temperature Low S41 (Status; Diagnosis)
- 6.1.43. Transducer Temperature Calibration S42 (Status; Diagnosis)

Appendix J: Hazardous area installations

- Wiring details
- Instructions specific to hazardous area installations

Wiring Details

Intrinsically Safe Model

FM/CSA: see *FM/CSA Intrinsically Safe Connection Drawing* on page 113 for reference drawing number 23650617)

Under the entity evaluation concept, SITRANS Probe LU has the following characteristics:

(input voltage) U_i	= 24 V DC (max.)
(input current) I_i	= 250 mA DC (max.)
(input power) P_i	= 1.2 W
(internal capacitance) C_i	= 0.5 nF
(internal inductance) L_i	= 0

Definition:

The Entity Concept allows interconnection of intrinsically safe apparatus to associated apparatus not specifically examined in such combination. The criteria for interconnection is that the voltage and current which intrinsically safe apparatus can receive and remain intrinsically safe, considering faults, must be equal to or greater than the output voltage (U_o) and output current (I_o) levels which can be delivered by the associated apparatus, considering faults and applicable factors. In addition, the maximum unprotected capacitance (C_i) and Inductance (L_i) of the intrinsically safe apparatus, including interconnecting wiring, must be equal to or less than the capacitance and inductance which can be safely connected to associated apparatus.

Under the FISCO evaluation concept, SITRANS Probe LU has the following characteristics:

(input voltage) U_i	= 17.5 V
(input current) I_i	= 380 mA
(input power) P_i	= 5.32 W
(internal capacitance) C_i	= 0.5 nF
(internal inductance) L_i	= 0

FISCO-Concept

Note: For complete details and instructions regarding the FISCO Concept, see page *FM/CSA Intrinsically Safe Connection Drawing on page 113* for drawing number 23650617, also available from the product page of our website: www.siemens.com/processautomation.

The FISCO Concept allows interconnection of intrinsically safe apparatus to associated apparatus not specifically examined in such combination. The criteria for interconnection is that the voltage (U_i or V_{max}), the current (I_i or I_{max}) and the power (P_i or P_{max}) which intrinsically safe apparatus can receive and remain intrinsically safe, considering faults, must be equal to or greater than the voltage (U_o or V_{oc} or V_i), the current (I_o or I_{sc} or I_i), and the power (P_o or P_{max}) levels which can be delivered by the associated apparatus, considering faults and applicable factors. In addition, the maximum unprotected capacitance (C_i) and inductance (L_i) of each apparatus (other than the termination) connected to the fieldbus must be less than or equal to 5 nF and 10 μ H respectively.

In each segment only one active device, normally the associated apparatus, is allowed to provide the necessary energy for the fieldbus system. The allowed voltage U_o (or V_{oc} or V_t) of the associated apparatus is limited to the range of 14V DC to 24V DC. All other equipment connected to the bus cable has to be passive, meaning that they are not allowed to provide energy to the system, except to a leakage current of 50 μ A for each connected device. Separately powered equipment needs a galvanic isolation to assure that the intrinsically safe fieldbus circuit remains passive.

FM/CSA

- Approved dust-tight and water-tight conduit seals are required for outdoor NEMA 4X / type 4X / NEMA 6, IP67, IP68 locations.
- The maximum voltage of the non-intrinsically safe apparatus must not exceed 250 V rms.

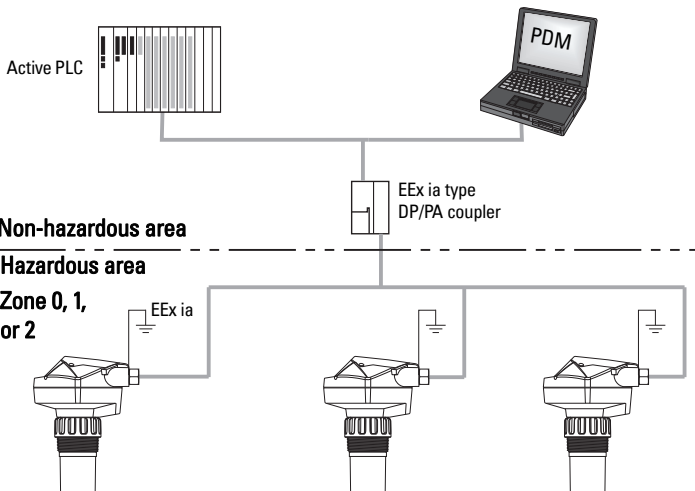

EU Equivalency

Any zener diode safety barrier, certified by an EU approved certification body to [EEx ia] IIC, its output voltage (U_o) not exceeding 24 V and its output current (I_o) limited by load resistance (R_o); such that $I_o = U_o / R_o$, does not exceed 250 mA.

Notes

- The installation must comply with national requirements.
- The safe area is unspecified except that it must not be supplied from nor contain, under normal or abnormal conditions, a source of potential with respect to earth in excess of 250 V rms or 250 V DC.

Wiring setups for hazardous area installations

Always check the device nameplate and process device tag to verify the approval rating.

1. Intrinsically Safe wiring

Device nameplate (ATEX/INMETRO/RCM)

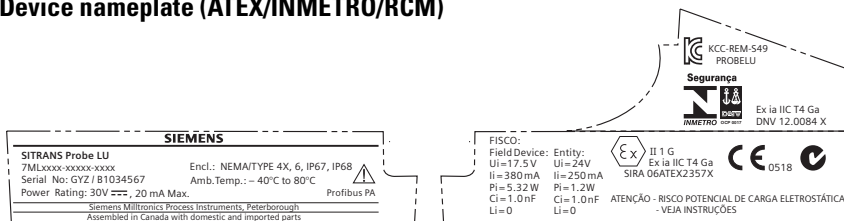

The ATEX certificate can be downloaded from the product page of our website at: www.siemens.com/probelu. Go to **Support > Approvals / Certificates**.

Device nameplate (FM/CSA)

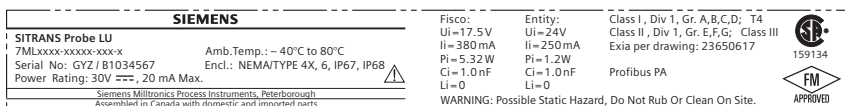

FM/CSA Intrinsically Safe connection drawing number **23650617** can be downloaded from the product page of our website at: www.siemens.com/probelu. Go to **Support > Installation Drawings > Level Measurement > Continuous - Ultrasonic**.

- For wiring requirements: follow local regulations.
- Approved dust-tight and water-tight conduit seals are required for outdoor Type 4X / NEMA 4X, Type 6 / NEMA 6, IP67, IP68 locations.

2. Non-incendive wiring (FM US only)

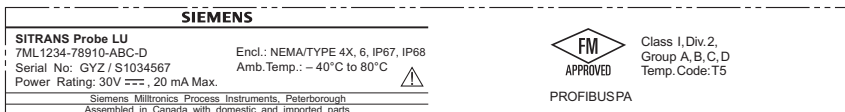

FM Class 1, Div 2 connection drawing number **23650583** can be downloaded from the product page of our website at: www.siemens.com/probelu. Go to **Support > Installation Drawings > Level Measurement > Continuous - Ultrasonic**.

Instructions specific to hazardous area installations (Reference European ATEX Directive 2014/34/EU, Annex II, 1/ 0/6)

The following instructions apply to equipment covered by certificate number SIRA
06ATEX2357X:

1. For use and assembly, refer to the main instructions.
2. The equipment is certified for use as Category 1G equipment.
3. The equipment may be used with flammable gases and vapors with apparatus group IIC and temperature class T4.
4. The equipment is certified for use in an ambient temperature range of $-40\text{ }^{\circ}\text{C}$ to $80\text{ }^{\circ}\text{C}$.
5. The equipment has not been assessed as a safety related device (as referred to by Directive 2014/34/EU Annex II, clause 1.5).
6. Installation and inspection of this equipment shall be carried out by suitably trained personnel in accordance with the applicable code of practice (EN 60079-14 and EN 60079-17 in Europe).
7. Repair of this equipment shall be carried out by suitably trained personnel in accordance with the applicable code of practice (e.g. EN 60079-19 within Europe).
8. Components to be incorporated into or used as replacements in the equipment shall be fitted by suitably trained personnel in accordance with the manufacturer's documentation.
9. It is the responsibility of the user to ensure that manual override is possible in order to shut down the equipment and protective systems incorporated within automatic processes which deviate from the intended operating conditions, provided that this does not compromise safety.
10. The 'X' suffix to the certificate number relates to the following special conditions for safe use:
 - a. Parts of the enclosure may be non-conducting and may generate an ignition-capable level of electrostatic charge under certain extreme conditions. The user should ensure that the equipment is not installed in a location where it may be subjected to external conditions (such as high-pressure steam) which might cause a build-up of electrostatic charge on non-conducting surfaces.
 - b. As either Aluminum, Magnesium, Titanium or Zirconium may be used at the accessible surface of the equipment, in the event of rare incidents, ignition sources due to impact and friction sparks could occur. This shall be considered when the SITRANS Probe LU (PROFIBUS PA) is being installed in locations that specifically require group II, category 1G equipment.

11. The certification of this equipment relies upon the following materials used in its construction:

Aluminum alloy ANSI ref. A380.0 (aluminum enclosure option)
STYCAST¹ 2651-40FR encapsulant, catalyst II

The detailed composition of Aluminum A380.0 as used in the metal enclosure (threaded lid option only) is as follows:

Si – 8.5%, Fe – 1.3%, Cu – 3.5%, Mn – 0.5%, Mg – 0.1%, Ni – 0.1%, Zn – 3%,
Sn – 0.35%, others – 0.5%, Al - balance

If the equipment is likely to come into contact with aggressive substances, then it is the responsibility of the user to take suitable precautions that prevent it from being adversely affected, thus ensuring that the type of protection is not compromised.

Aggressive substances: e.g. acidic liquids or gases that may attack metals, or solvents that may affect polymeric materials.

Suitable precautions: e.g. regular checks as part of routine inspections or establishing from the material's data sheet that it is resistant to specific chemicals.

12. **Equipment Marking:**

The equipment marking contains at least the information on the product label, shown on the inside front cover of this manual.

¹ STYCAST® is a registered trademark of the National Starch and Chemical Company.

FM/CSA Intrinsically Safe Connection Drawing

Note: Reference drawing 23650617 is available from the product page of our website at: www.siemens.com/probelu.

FISCO-Concept

The FISCO Concept allows interconnection of intrinsically safe apparatus to associated apparatus not specifically examined in such combination. The criteria for interconnection is that the voltage (U_i or V_{max}), the current (I_i or I_{max}) and the power (P_i or P_{max}) which intrinsically safe apparatus can receive and remain intrinsically safe, considering faults, must be equal or greater than the voltage (U_0 or V_{oc} or V_i), the current (I_0 or I_{sc} or I_i) and the power (P_0 or P_{max}) levels which can be delivered by the associated apparatus, considering faults and applicable factors. In addition, the maximum unprotected capacitance (C_i) and inductance (L_i) of each apparatus (other than the termination) connected to the fieldbus must be less than or equal to 5 nF and 10 μ H respectively.

In each segment only one active device, normally the associated apparatus, is allowed to provide the necessary energy for the fieldbus system. The allowed voltage U_0 (or V_{oc} or V_i) of the associated apparatus is limited to the range of 14V dc to 24V dc. All other equipment connected to the bus cable has to be passive, meaning that they are not allowed to provide energy to the system, except to a leakage current of 50 μ A for each connected device. Separately powered equipment needs a galvanic isolation to assure that the intrinsically safe fieldbus circuit remains passive.

The cable used to interconnect the devices needs to have the parameters in the following range:

loop resistance R^* : 15 ... 150 Ω / km
 inductance per unit length L^* : 0,4 ... 1 mH / km
 capacitance per unit length C^* : 80 ... 200 nF / km

$C^* = C^*_{line/line} + 0.5 C^*_{line/screen}$, if both lines are floating or
 $C^* = C^*_{line/line} + C^*_{line/screen}$, if the screen is connected to one line

Maximum allowed cable length:	CLASS I, ZONE 0 ia	CLASS I, ZONE 1 ib
Length of spur cable:	≤ 30 m	≤ 30 m
Length of trunk cable:	≤ 1 km	≤ 5 km
Total length (sum of trunk and spur cables)	≤ 1 km	≤ 5 km
Length of splice	≤ 1 m	≤ 1 m

At each end of the trunk cable an approved infallible line termination with the following parameters is suitable:

$R = 90 \dots 100 \Omega$
 $C = 0 \dots 2.2 \mu F$.

One of the allowed terminations might already be integrated in the associated apparatus.

The number of passive devices connected to the bus segment is not limited due to I.S. reasons. If the above rules are respected, up to the specified total length, the inductance and capacitance of the cable will not impair the intrinsic safety or the installation.

		1	CHANGE CI RATING PER ECO 79B35457	RPC	SN	JAN 19 / 2007
USE DIMENSIONS ONLY - DO NOT SCALE		0	FOR CONSTRUCTION	RPC	SN	APRIL 18 / 2005
DIMENSIONS ARE IN INCHES		Rev.	Revision / ECN Description	Drawn	Appr.	Date
<p>Third Angle Projection</p>	Product Group ULTRASONICS		Tolerance Unless Otherwise Noted: UOS 1 Place Decimal ± 0.03 Angles: $\pm 0.5^\circ$ 2 Place Decimal ± 0.01 3 Place Decimal ± 0.002		Scale: NTS	Size: A
	Date: 18 / APRIL / 2005		TITLE: SITRANS Probe LU PROFIBUS PA CONNECTION DRAWING			
Drawn: R. CLYSDALE		DRAWING No: 23650617				
Checked: E. DeSIMONE		Rev: 1				
Approved: S. NGUYEN						
Location: PETERBOROUGH						
SIEMENS MILLTRONICS PROCESS INSTRUMENTS INC. Peterborough, Ontario, Canada						
File No. 2365061701		Plot at: 1 : 1		Sheet 1 Of 4		

J. Hazardous installation

The number of passive devices connected to the bus segment is not limited due to I.S. reasons. If the above rules are respected, up to the specified total length, the inductance and capacitance of the cable will not impair the intrinsic safety or the installation.

Notes:

**INTRINSICALLY SAFE CLASS I, II, III DIV. 1, GROUPS A, B, C, D, E, F, G
CLASS I, ZONE 0/1 GROUPS IIB / IIC**

- Approved apparatus must be installed in accordance with manufacturer instructions.
- Approved associated apparatus must meet the following requirements:
 U_o or V_{oc} or $V_t \leq U_i$ (V_{max}) and I_o or I_{sc} or $I_t \leq I_i$ (I_{max}) and P_o or $P_{max} \leq P_i$ (P_{max})
- The maximum non-hazardous area voltage must not exceed 250 V.
- In the USA the installation must be in accordance with the National Electrical Code NFPA 70, Article 504, resp. Article 505 and ANSI/ISA-Rp 12.6 (except chapter 5). In Canada observe the Canadian Electrical Code.
- Multiple earthing of screen is allowed only, if high integrity equipotential system is realized between the points of bonding.
- WARNING:** Substitution of components may impair intrinsic safety.

FM applications: NONINCENDIVE, CLASS I, II, III DIV. 2, GROUPS A, B, C, D, E, F, G

- Intrinsic safety barrier not required. Max. supply voltage 30 V.
- WARNING:** Explosion Hazard - do not disconnect equipment unless power has been switched off or the area is known to be Non- Hazardous.
- WARNING:** Substitution of components may impair suitability for Class I, Division 2.

USE DIMENSIONS ONLY - DO NOT SCALE		SEE SHEET 1				
DIMENSIONS ARE IN INCHES		Rev.	Revision / ECN Description	Drawn	Appr.	Date
<p>Third Angle Projection</p>	Product Group	ULTRASONICS	Tolerance Unless Otherwise Noted: UOS 1 Place Decimal ± 0.03 Angles: 2 Place Decimal ± 0.01 $\pm 0.5^\circ$ 3 Place Decimal ± 0.002	Scale:	NTS	Size:
	Date:	18 / APRIL / 2005				A
	Drawn:	R. CLYSDALE	TITLE: SITRANS Probe LU PROFIBUS PA CONNECTION DRAWING			
	Checked:	E. DeSIMONE	DRAWING No: 23650617			
	Approved:	S. NGUYEN				
	Location:	PETERBOROUGH	Rev: 1			
	SIEMENS MILLTRONICS PROCESS INSTRUMENTS INC. Peterborough, Ontario, Canada	File No. 2365061701		Plot at: 1 : 1	Sheet 2 Of 4	

J: Hazardous installation

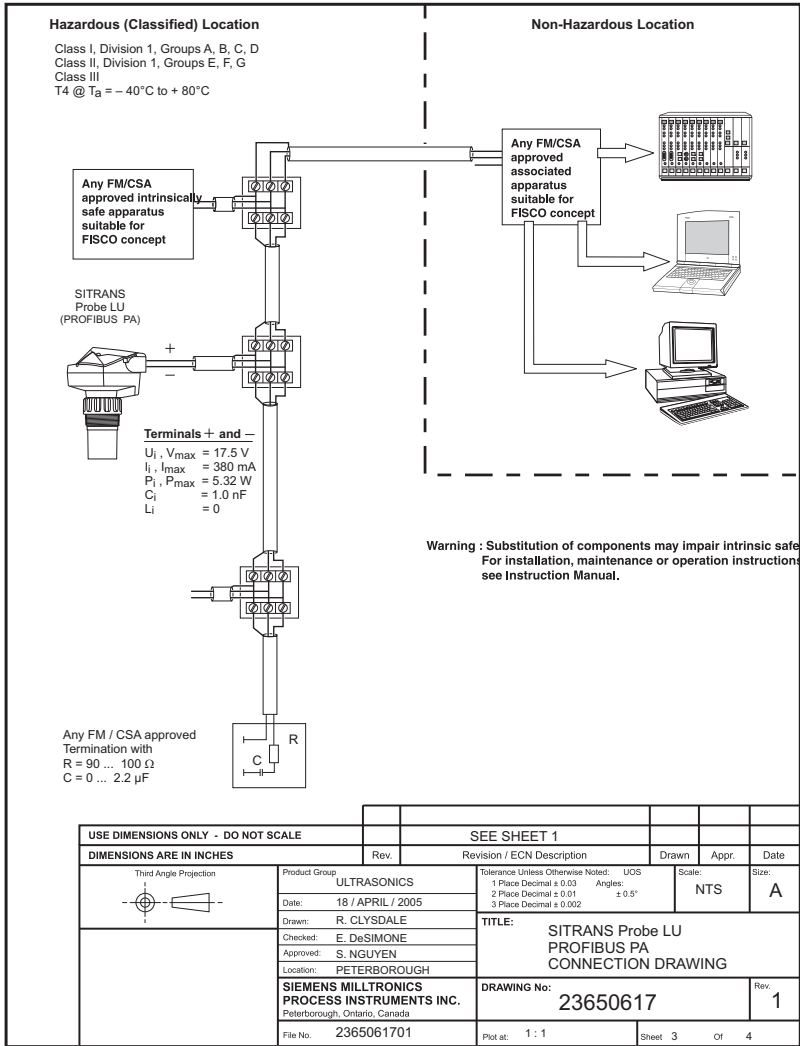

J. Hazardous installation

Hazardous (Classified) Location

Class I, Division 1, Groups A, B, C, D
 Class II, Division 1, Groups E, F, G
 Class III
 T4 @ T_a = - 40°C to + 80°C



Entity parameters:

Terminals + and -

U_i , V_{max} = 24 V
 I_i , I_{max} = 250 mA
 P_i , P_{max} = 1.2 W
 C_i = 1.0 nF
 L_i = 0

Non-Hazardous Location

Intrinsic safety barrier

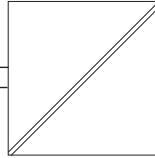

See Note 1

For Intrinsic safety application use CSA / FM approved associated apparatus or barrier

Entity parameters:

V_{oc} or V_t ≤ 24 V
 I_{sc} or I_t ≤ 250 mA
 P_o or P_t ≤ 1.2 W
 C_a ≥ 1.0 nF + C cable
 L_a ≥ 0 + L cable

Notes:

1. The non-intrinsically safe terminals (power rail) must not be connected to any device which uses or generates more than 250 Vrms or dc unless it has been determined that the voltage has been adequately isolated.
2. In the USA the installation must meet the requirements of the National Electrical Code, NFPA 70. article 504 resp. article 505 and ANSI / ISA RP 12.6 . In Canada observe the Canadian Electrical Code.
3. Multiple earthing of screen is allowed only, if high integrity equipotential system is realized between the points of bonding.

Warning : Substitution of components may impair intrinsic safety. For installation, maintenance or operation instructions,

USE DIMENSIONS ONLY - DO NOT SCALE		SEE SHEET 1	
DIMENSIONS ARE IN INCHES		Rev.	Revision / ECN Description
	Product Group: ULTRASONICS Date: 18 / APRIL / 2005 Drawn: R. CLYSDALE Checked: E. DeSIMONE Approved: S. NGUYEN Location: PETERBOROUGH	Tolerance Unless Otherwise Noted: UOS 1 Place Decimal ± 0.03 Angles: ± 0.5° 2 Place Decimal ± 0.01 3 Place Decimal ± 0.002	Scale: NTS Size: A
SIEMENS MILLTRONICS PROCESS INSTRUMENTS INC. Peterborough, Ontario, Canada		TITLE: SITRANS Probe LU PROFIBUS PA CONNECTION DRAWING	
File No: 2365061701		DRAWING No: 23650617 Rev: 1	
Plot No: 2365061701		Plot at: 1 : 1 Sheet 4 Of 4	

J: Hazardous installation

FM: Class I, Div. 2 Connection Drawing

Note: Reference drawing 23650583 is available from the product page of our website at: www.siemens.com/probelu.

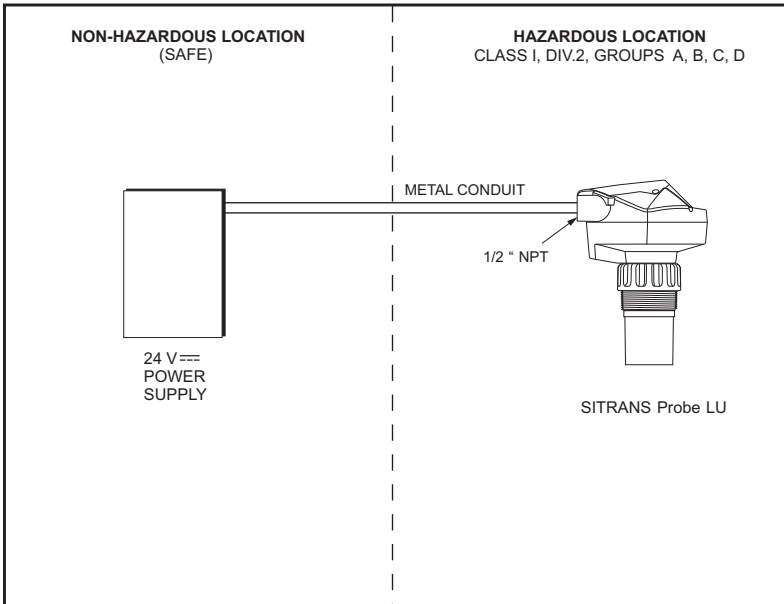

NOTES:

- 1) INSTALLATION SHALL BE DONE IN ACCORDANCE WITH THE NATIONAL ELECTRICAL CODE.
- 2) USE APPROVED WATER TIGHT CONDUIT FITTINGS FOR OUTDOOR APPLICATIONS.
- 3) FOR FURTHER INFORMATION REFER TO THE SITRANS Probe LU INSTRUCTION MANUAL.

1							
USE DIMENSIONS ONLY - DO NOT SCALE		0		FOR CONSTRUCTION		RPC SN SEPT 28/2004	
DIMENSIONS ARE IN INCHES		Rev.		Revision / ECN Description		Drawn Appr. Date	
<p>Third Angle Projection</p>		Product Group ULTRASONICS Date: 29 / SEPT / 2004 Drawn: R. CLYSDALE Checked: S. MILLIGAN Approved: S. NGUYEN Location: PETERBOROUGH		Tolerance Unless Otherwise Noted: UDS 1 Place Decimal ± 0.03 2 Place Decimal ± 0.01 3 Place Decimal ± 0.002 Angles: ± 0.5°		Scale: NTS Size: A	
FOR INTERNAL USE ONLY		TITLE: SITRANS Probe LU CLASS I, Div. 2 CONNECTION DRAWING					
		DRAWING No: 23650583		Rev: 0			
File No. 2365058300		Plot at: 1 : 1		Sheet 1 Of 1			

J. Hazardous installation

Appendix K: Firmware Revision History

Firmware Rev.	DD Rev.	Date	Changes
1.02	1.02.01	15 Aug 2005	
1.03	1.03.01	21 Sept 2005	<ul style="list-style-type: none">• Corrects a defect in the Volume Breakpoint table, where the table was not restored after a power failure.
1.04	1.04.00	5 Mar 2007	<ul style="list-style-type: none">• updated Profibus Ident Number.
1.05	1.03.02	9 May 2008	<ul style="list-style-type: none">• Maintenance release
1.06	1.03.02	14 May 2013	<ul style="list-style-type: none">• Maintenance release

Glossary

Note: Parameter names are capitalized.

acoustic noise: any undesired audible sound.

accuracy: degree of conformity of a measure to a standard or a true value.

agitator: mechanical apparatus for mixing or aerating. A device for creating turbulence.

algorithm: a prescribed set of well-defined rules or processes for the solution of a problem in a finite number of steps.

ambient temperature: the temperature of the surrounding air that comes in contact with the enclosure of the device.

attenuation: a term used to denote a decrease in signal magnitude in transmission from one point to another. Attenuation may be expressed as a scalar ratio of the input magnitude to the output magnitude or in decibels.

Auto False-Echo Suppression: a technique used to adjust the level of a TVT curve to avoid the reading of false echoes. (See TVT.)

Auto False-Echo Suppression Distance: defines the endpoint of the TVT distance. (See TVT.) This is used in conjunction with auto false echo suppression.

beam angle: the angle diametrically subtended by the one-half power limits (-3 dB) of the sound beam.

beam spreading: the divergence of a beam as it travels through a medium.

blanking: the distance in front of the transducer face where level measurement is not possible.

capacitance: the property of a system of conductors and dielectrics that permits the storage of electricity when potential differences exist between the conductors. Its value is expressed as the ratio of a quantity of electricity to a potential difference, and the unit is a Farad.

confidence: describes the quality of an echo. Higher values represent higher quality. Confidence threshold defines the minimum value.

damping: term applied to the performance of an instrument to denote the manner in which the measurement settles to its steady indication after a change in the value of the level.

dB (decibel): a unit used to measure the amplitude of signals.

- derating:** to decrease a rating suitable for normal conditions according to guidelines specified for different conditions.
- dielectric:** a nonconductor of direct electric current.
- echo:** a signal that has been reflected with sufficient magnitude and delay to be perceived in some manner as a signal distinct from that directly transmitted. Echoes are frequently measured in decibels relative to the directly transmitted signal.
- echo confidence:** the recognition of the validity of the echo. A measure of echo reliability.
- Echo Lock Window:** a window centered on an echo in order to locate and display the echo's position and true reading. Echoes outside the window are not immediately processed.
- Echo Marker:** a marker that points to the processed echo.
- Echo Processing:** the process by which the device determines echoes.
- Echo Strength:** describes the strength of the selected echo in dB above 1 μ V rms.
- Echo Profile:** a graphical display of a processed echo.
- electrical noise:** unwanted electrical signals that produce undesirable effects in the circuits of the control systems in which they occur.
- false echo:** any echo which is not the echo from the desired target. Generally, false echoes are created by vessel obstructions.
- firmware:** the software embedded in the device
- frequency:** the number of periods occurring per unit time. Frequency may be stated in cycles per second.
- hertz (Hz):** unit of frequency, one cycle per second. 1 kilohertz (kHz) is equal to 10^3 Hz.
- HART: Highway Addressable Remote Transducer.** An open communication protocol used to address field instruments.
- inductance:** the property of an electric circuit by virtue of which a varying current induces an electromotive force in that circuit or in a neighboring circuit. The unit is a Henry.
- multiple echoes:** secondary echoes that appear as double, triple, or quadruple echoes in the distance from the target echo.

Near Blanking: see Blanking

nozzle: a length of pipe mounted onto a vessel that supports the flange.

parameterize: to set the values of the parameters that define the functionality of the device

parameters: in programming, variables that are given constant values for specific purposes or processes.

pulse: a wave that departs from an initial level for a limited duration of time, and returns to the initial level.

“rack”: when configuring SITRANS Probe LU with Step 7, the Probe LU has a virtual “rack” to hold data

range: distance between a transmitter and a target.

range extension: the distance below the zero percent or empty point in a vessel.

repeatability: the closeness of agreement among repeated measurements of the same variable under the same conditions.

shot: one transmit pulse or measurement.

stillpipe: a pipe that is mounted inside a vessel parallel to the vessel wall, and is open to the vessel at the bottom.

stilling-well: see **stillpipe**.

TVT (time varying threshold): a time-varying curve that determines the threshold level above which echoes are determined to be valid.

ultrasonic: having a frequency above the human ear’s audibility limit: about 20,000 hertz.

wear: difference between a current measurement and the benchmark value separating the startpoint and endpoint of, for example, device lifetime. If the current value is less than the benchmark, it indicates a ‘wear’. This does not have to be measured in time: it could be, for example, the percentage loss of a protective coating.

Notes

Index

A

- abbreviations and identifications
 - list **2**
- acyclic diagnostics **29**
- address **77**
- agitator blade detection
 - avoiding **82**
- agitators **82**
- alarm limits **102**
- analog input function block
 - input (Process Variable) **62**
- analog input function blocks **68**
- applications **5**
- approvals **9**
- auto false echo suppression
 - description **39**
 - setup **97**

B

- bar graph **17**
- beam angle **8**
- blanking
 - see near range **39**
- breakpoints
 - entering **91**
- bus termination **24**

C

- calibration **21**
 - performing **84**
- condensed status
 - codes **27**
- configuration **24**
- configuration parameters **77**
- connecting Probe LU **15**
- current consumption
 - PROFIBUS current user-selectable **24**
 - setting PROFIBUS **83**
- cyclic data **25**
 - versus acyclic **25**

D

- data map **65**
- device description (DD) **23**
- diagnosis reply **29**
- diagnostics **29**
- dimensions **13**
- distance 1 (SV2) **62**
- distance 2 (SV3) **62**

E

- echo lock
 - description **37**
 - setting **82**
- echo status indicator
 - reliable echo **17**
 - unreliable echo **17**
- edit mode
 - handheld programmer **48**
- electronics temperature **62**

F

- factory reset
 - setting **78**
- failsafe
 - description **38**
 - mode selection **103**
 - output options **63**
 - set LOE timer **90**
 - value **103**
- false echoes **39**
- fault codes
 - acyclic extended diagnostics **31**
- flange adaptor **13**
- flow
 - calculating **91**
- frequency **7**
- function blocks
 - analog input function blocks **62**
 - block model **59**
 - level transducer block **60**
- function keys
 - confidence key **48**
 - edit mode **49**
 - measure key **48**
 - navigation mode **49**
 - temperature key **48**

G

- general fault codes **31**
- grounding **16**
- GSD file **24**

H

- handheld programmer
 - edit mode **48**
 - navigation mode **48**
 - overview **18**
 - specifications **10**
- hazardous area installations
 - wiring requirements **110**
- hysteresis
 - setting **103**

specifications **7**

I

identifications and abbreviations

list **2**

input simulation **63**

installation

hazardous area requirements **110**

hazardous areas **107**

intrinsically safe **107**

mounting instructions **12**

mounting location **11**

L

level

LTB output **62**

level offset **86**

level transducer block **70**

output **62**

liability **45**

limit hysteresis

setting **103**

linear conversion **63**

linearization

setting **87**

local operation enable

description **19**

LOE **38**

LOE timer

description **38**

setting **90**

loop voltage vs. loop resistance

power supply requirements **110**

loss of echo

description **38**

M

maintenance **45**

maintenance settings **104**

master reset

via hand programmer **51**

via PDM **19, 78**

material mixers **82**

measurement range **7**

measurement response

description **37**

measuring limits

setting **86**

memory **8**

menu structure

charts **55**

menu timeout **78**

N

near range (blanking)

description **39**

specifications **7**

network address **24**

O

offset

level **86**

sensor **86**

offset calibration **94**

OUT VALUE parameter **64**

output conversion **63**

output limits

alarms and warnings **102**

output scale

setting **102**

P

parameters

individual reset locally **51**

menus **77**

quick access **77**

setting remotely **35**

PDM **23**

performance

accuracy **7**

deadband (resolution) **7**

frequency **7**

hysteresis error **7**

measurement range **7**

non-repeatability (repeatability) **7**

temperature compensation **8**

update time **8**

physical block **65**

power demands

current consumption **24**

PROFIBUS current user-selectable **24**

power supply

requirements **7**

power supply requirements

loop voltage vs. loop resistance **110**

primary region

PROGRAM mode **19**

RUN mode **17**

primary value (PV)

becomes process variable **62**

LTB output **62**

volume output **62**

principles of operation **37**

process temperature

specifications **9**

process value scale
 setting **102**
 process variable
 AIFB input **62**
 range **63**
 PROFIBUS address **77**
 setting **24**
 setting via handheld programmer **20**
 PROFIBUS current consumption
 setting **83**
 PROFIBUS PA
 profile structure **59**
 program mode icon **19**
 programming **18**
 locally **47**
 quick setup **20**

Q
 quick setup **20**

R
 reliable echo indicator **17**
 remote lockout
 setting **78**
 remote operation
 via PROFIBUS PA **23**
 remote operation enable
 description **19**
 via handheld programmer **50**
 repair **45**
 reset fault
 setting **78**
 resolution
 see deadband **7**
 response rate
 description **37**
 setting **82**

S
 safety marking symbols **1**
 safety notes **1**
 scaling input **63**
 secondary region
 PROGRAM mode **19**
 RUN mode **17**
 secondary value
 LTB output **62**
 secondary value 1 (SV1)
 level **62**
 secondary value 2 **62**
 secondary value 2 (SV2)
 distance 1 **62**
 secondary value 3 (SV3)
 distance 2 **62**
 security
 local operation enable **19**
 remote operation enable **19**
 write locking **19**
 sensor calibration **84**
 sensor offset **86**
 SIMATIC PDM **23**
 SITRANS Probe LU
 overview **4**
 sound velocity calibration **94**
 startup **20**
 status byte
 status codes **26**
 system implementation **5**

T
 temperature compensation **8**
 troubleshooting **43**
 TVT curve **39**
 TVT setup **97**

U
 unreliable echo indicator **17**
 update time **8**

V
 velocity calibration **94**
 vessel shape
 selection **88**
 volume output **62**

W
 warning limits **102**
 wiring
 power requirements **15**
 write locking
 description **19**
 via handheld programmer
 50

Z
 zener diode safety barriers **109**

For more information

www.siemens.com/level

www.siemens.com/weighing

Siemens Canada Limited
1954 Technology Drive
P.O. Box 4225
Peterborough, ON
Canada K9J 7B1

Subject to change without prior notice
A5E32337708 Rev. AC
© Siemens AG 2017

*** A5E 32337708 ***

Printed in Canada

www.siemens.com/processautomation