

**SIEMENS**



# Ultrasonic controllers

MultiRanger 100/200

Operating Instructions

Edition

11/2019

**Safety Guidelines:** Warning notices must be observed to ensure personal safety as well as that of others, and to protect the product and the connected equipment. These warning notices are accompanied by a clarification of the level of caution to be observed.

**Qualified Personnel:** This device/system may only be set up and operated in conjunction with this manual. Qualified personnel are only authorized to install and operate this equipment in accordance with established safety practices and standards.

**Unit Repair and Excluded Liability:**

- The user is responsible for all changes and repairs made to the device by the user or the user's agent.
- All new components are to be provided by Siemens Milltronics Process Instruments Inc.
- Restrict repair to faulty components only.
- Do not reuse faulty components.

**Warning:** Cardboard shipping package provides limited humidity and moisture protection. This product can only function properly and safely if it is correctly transported, stored, installed, set up, operated, and maintained.

**This product is intended for use in industrial areas. Operation of this equipment in a residential area may cause interference to several frequency based communications.**

**Note:** Always use product in accordance with specifications.

<b>Copyright Siemens Milltronics Process Instruments Inc. 2009. All Rights Reserved</b>	<b>Disclaimer of Liability</b>
This document is available in bound version and in electronic version. We encourage users to purchase authorized bound manuals, or to view electronic versions as designed and authored by Siemens Milltronics Process Instruments Inc. Siemens Milltronics Process Instruments Inc. will not be responsible for the contents of partial or whole reproductions of either bound or electronic versions.	While we have verified the contents of this manual for agreement with the instrumentation described, variations remain possible. Thus we cannot guarantee full agreement. The contents of this manual are regularly reviewed and corrections are included in subsequent editions. We welcome all suggestions for improvement.  Technical data subject to change.

MILLTRONICS® is a registered trademark of Siemens Milltronics Process Instruments Inc.

**Contact SMPI Technical Publications at the following address:**

Technical Publications  
Siemens Milltronics Process Instruments Inc.  
1954 Technology Drive, P.O. Box 4225  
Peterborough, Ontario, Canada, K9J 7B1  
Email: [techpubs.smpi@siemens.com](mailto:techpubs.smpi@siemens.com)

**European Authorized Representative**

Siemens AG  
Industry Sector  
76181 Karlsruhe  
Deutschland

- For a selection of Siemens Milltronics level measurement manuals, go to: **[www.siemens.com/processautomation](http://www.siemens.com/processautomation)**. Under Process Instrumentation, select *Level Measurement* and then go to the manual archive listed under the product family.
- For a selection of Siemens Milltronics weighing manuals, go to: **[www.siemens.com/processautomation](http://www.siemens.com/processautomation)**. Under Weighing Technology, select *Continuous Weighing Systems* and then go to the manual archive listed under the product family.

# Table of Contents

---

<b>The MultiRanger 100 and 200</b> .....	1
MultiRanger 100 .....	1
MultiRanger 200 .....	1
The Manual .....	1
Manual Symbols .....	2
Configuration Examples .....	2
<b>Specifications</b> .....	3
<b>Installation</b> .....	8
Mounting .....	8
Mounting Locations .....	8
Mounting Instructions .....	9
Wall Mount .....	9
Cable routed through a conduit .....	10
Panel Mount .....	11
Mounting the Enclosure .....	12
MultiRanger Board .....	13
Installing the Battery .....	13
Installing SmartLinx Card .....	14
<b>Wiring</b> .....	15
Terminal Board .....	16
Cables .....	16
Transducers .....	17
Relays .....	17
Temperature Sensor .....	18
mA Input [MR 200 only] .....	18
mA Output .....	18
Level System Synchronization .....	19
Power .....	19
Digital Communications .....	20
RS-232 Serial Connection .....	20
RS-485 Serial Connection .....	20
Discrete Inputs .....	21
<b>Operating the MultiRanger</b> .....	22
RUN Mode .....	22
Readings in RUN Mode .....	23
Status Parameters .....	24
Controlling the Display .....	25
Adjusting the primary reading for four-digit LCD readout .....	25
Auxiliary Reading .....	25
Multiple Readings [MR 200 only] .....	26
PROGRAM Mode .....	27
Starting PROGRAM Mode .....	27

Hand Programmer .....	27
Programmer Keys .....	28
Dolphin Plus .....	29
Dolphin Plus Toolbar Buttons .....	30
SIMATIC Process Device Manager (PDM) .....	31
Device Description .....	31
Activating the MultiRanger .....	32
Changing Parameters .....	32
Security .....	33
Using Units or Percent (%) .....	33
Parameters Types .....	33
Parameter Reset .....	34
Display Readout .....	34
Changing Parameters(Dolphin Plus) .....	35
Parameter Indexing .....	36
Primary and Secondary Indexes .....	37
Primary Index .....	37
Secondary Index.....	37
Starting Measurement .....	38
Single Point Models .....	38
Average or Differential [MR 200 only].....	39
Dual Point Models .....	39
Average or Differential [MR 200 only].....	40
Measurement Conditions .....	40
Response Rate .....	40
Dimensions [MR 200 only].....	40
Failsafe.....	40
<b>Relays</b> .....	41
General Introduction .....	41
Relay Function .....	41
Alarm.....	41
Pump.....	42
Miscellaneous.....	42
Relay Status – Non Run Modes .....	43
Relay States .....	43
Relay Related Parameters .....	43
Relay Wiring Test.....	44
Relay Activation .....	44
Relay Failsafe .....	45
Preset Applications .....	46
<b>Backup Level Override</b> .....	47
Backup Level Override Parameters .....	47
<b>Discrete Inputs</b> .....	48
Wiring the Discrete Inputs .....	48
Programming the Discrete Input Logic .....	48

<b>mA I/O</b> .....	49
mA Input [MR 200] .....	49
mA Output .....	49
<b>Volume [MR 200]</b> .....	51
Readings .....	51
Tank Shape and Dimensions .....	51
Characterization Chart [MR 200] .....	52
Example Chart .....	52
MultiRanger 200 only .....	53
<b>Alarms</b> .....	54
Level .....	54
Setting Simple Level Alarms .....	55
Rate [MR 200] .....	55
In Bounds/ Out of Bounds Range [MR 200] .....	56
Cable Fault .....	56
Temperature [MR 200] .....	56
Loss of Echo (LOE) .....	57
<b>Pump Control</b> .....	58
Setting a Pump Down Group .....	58
Setting a Pump Up (Reservoir) Group .....	59
Other Pump Control Algorithms .....	61
Set Relays to ALTERNATE DUTY BACKUP [MR 200] .....	61
Set Relays to FIXED DUTY ASSIST .....	61
Set Relays to FIXED DUTY BACKUP [MR 200] .....	62
Set Relays to ALTERNATE DUTY SERVICE [MR 200] .....	62
Set Relays to FIRST IN FIRST OUT (FIFO) ASSIST [MR 200] .....	63
Optional Pump Controls .....	63
Starting Pumps by Rate of Level Change [MR 200] .....	63
Rotating Pumps by Service Ratio [MR 200] .....	64
Totalizing Pumped Volume [MR 200] .....	65
Setting Independent Failsafe Controls .....	65
Setting a Pump to Run On [MR 200] .....	66
Setting the Pump Start Delays [MR 200] .....	66
Reducing Wall Cling [MR 200] .....	66
Grouping Pumps [MR 200] .....	67
Setting a Flush Valve [MR 200] .....	67
Relay Controlled by Communications .....	68
Tracking Pump Usage .....	68
<b>Rake (Screen) Control [MR 200]</b> .....	69
Setting a Rake Control .....	69

Setting the Common Parameters .....	70
Set Relay 1 (Operate Rake) .....	70
Set Relays 2 to 4 (Level Alarms) .....	70
<b>External Totalizers and Flow Samplers [MR 200] .....</b>	<b>71</b>
Relay Contacts .....	71
Totalizer .....	71
Flow Sampler .....	72
Based on Volume and Time .....	72
<b>Open Channel Monitoring (OCM)</b>	
<b>[MR 200] .....</b>	<b>73</b>
Common Parameters .....	73
Setting Zero Head .....	74
Setting Totalized Volume .....	75
Applications Supported by MultiRanger 200 .....	75
BS-3680 / ISO 1438/1 Thin plate V notch weir .....	75
BS-3680 / ISO 4359 Rectangular Flume .....	76
Palmer Bowlus Flume .....	77
H Flume .....	78
PMDs with Exponential Flow to Head Function .....	79
Applicable Weir Profiles .....	79
Non-Applicable Weir Profiles .....	80
Parshall Flume .....	80
Leopold Lagco Flume .....	81
Cut Throat Flume .....	82
Universal Calculation Support .....	83
Typical Flow Characterization .....	83
Example Flumes .....	84
Example Weirs .....	84
<b>Testing the Configuration .....</b>	<b>85</b>
Simulation .....	85
Simulating a Single Measurement .....	85
Simulating a Level Cycle .....	85
Checking Volume Characterization [MR 200] .....	86
Checking OCM Flow Characterization [MR 200] .....	86
I/O Checkout .....	87
Application Test .....	87
<b>MultiRanger Communications .....</b>	<b>89</b>
MultiRanger Communication Systems .....	89
Optional SmartLinx® Cards .....	89
Communication Systems .....	90
Communication Ports .....	90
Modbus .....	90
SmartLinx .....	91
Dolphin Plus .....	91

<b>Communications Installation</b> .....	92
Wiring Guidelines .....	92
Ports 1 and 2 .....	92
Ports 1 and 2: RS-232 RJ-11 Jack and RS-485 Locations .....	92
Port 1: RS-232 RJ-11 Jack .....	93
Port 2: RS-485 .....	93
Configuring Communication Ports (Parameters) .....	94
<b>Modbus Register Map</b> .....	97
Word Order (R40,062) .....	98
Map ID (R40,063) .....	98
Product ID (R40,064) .....	99
Point Data (R41,010 – R41,031) .....	99
Totalizer (R41,040 – R41,043) .....	99
Input/Output (R41,070 – R41,143) .....	99
Discrete Inputs (R41,070) .....	100
Relay Outputs (R41,080) .....	100
mA Input (R41,090) [MR 200] .....	100
mA Output (R41,110-41,111) .....	100
Pump Control (R41,400 – R41,474) .....	100
Pump ON Setpoint (R41,420 – R41,425) .....	100
Pump OFF Setpoint (R41,430 – R41,435) .....	101
Pumped Volume (R41,440 – R41,443) [MR 200] .....	101
Pump Hours (R41,450 – R41,461) .....	101
Pump Starts (R41,470 – R41,475) .....	101
Parameter Access (R43,998 – R46,999) .....	102
Parameter Indexing .....	102
Indexing the Parameter Access Area.....	102
Reading Parameters .....	103
Global Index Method (P782 = 0).....	103
Parameter Specific Index Method (P782 = 1) .....	103
Writing Parameters .....	104
Global Index Method (P782 = 0).....	104
Parameter Specific Index Method (P782 = 1).....	104
Format Words (R46,000 to R46,999) .....	105
Global Index Method (P782 = 0) .....	105
Parameter-Specific Index Method (P782 = 1) .....	105
Format Registers .....	105
<b>Data Types</b> .....	107
Numeric Values .....	107
Bit Values .....	107
Unsigned Double Precision Integer (UINTEGER) .....	107
Split Values .....	108
Text Messages .....	109
Relay Function Codes (P111 Only) .....	110
<b>Error Handling</b> .....	111
Modbus Responses .....	111

Error Handling .....	111
<b>Communication Troubleshooting .....</b>	<b>113</b>
Generally .....	113
Specifically .....	113
<b>Communication Appendix A: Single Parameter Access (SPA) .....</b>	<b>114</b>
Mapping .....	114
Reading Parameters .....	114
Writing Parameters .....	115
Format Register .....	115
Error Codes .....	116
<b>Parameter Reference .....</b>	<b>117</b>
MultiRanger 100 and MultiRanger 200 .....	117
Helpful Hints .....	117
Index types .....	118
Quick Start (P001 to P007) .....	119
For DPD and DPA Programming [MR 200] .....	120
Volume (P050 to P055) [MR 200] .....	123
Display and Reading (P060 to P062) .....	127
Backup Level Override .....	129
Failsafe (P070 to P072) .....	131
Relays (P100 to P119) .....	132
MultiRanger 200 .....	134
Pump Setpoint Modifiers (P121 and P122) [MR 200] .....	139
Independent Relay Failsafe (P129) .....	140
Advanced Pump Control Modifiers (P130 to P137) [MR 200] .....	141
Flush Systems (P170 to P173) [MR 200] .....	144
mA Output (P200 to P219) .....	146
Independent mA Setpoints (P210 and P211) .....	149
mA Output Limits (P212 and P213) .....	149
mA Output Trim (P214 to P215) .....	150
mA Output Failsafe (P219) [MR 200] .....	151
mA Input (P250 to P260) [MR 200] .....	151
Discrete Input Functions (P270 to P275) .....	153
Standard Data Logging (P300 to P321) .....	154
Record Temperatures (P300 to P303) .....	154
Record Readings (P304 and P305) .....	156
Pump Records (P309 to P312) .....	156
Flow Records (P320 and P321) [MR 200] .....	158
LCD Totalizer (P322 and P323) [MR 200] .....	158
Profile Records (P330 to P337) .....	159
Auto Record ON and OFF Setpoints (P334 to P337) .....	162
Installation Records (P340 to P342) .....	164
Open Channel Monitoring (P600 to P621) [MR 200] .....	165
Example Exponents .....	167
Pumped Volume Totalizer (P622) [MR 200] .....	174
Totalizer (P630 to P645) [MR 200] .....	175
Range Calibration (P650 to P654) .....	178



Temperature Compensation (P660 to P664) .....	181
Rate (P700 to P708) .....	183
Measurement Verification (P710 to P713) .....	187
Transducer Scanning (P726 to P729) .....	190
Display (P730 to P739) .....	191
SmartLinx Reserved (P750 to P769) .....	194
Communications (P770 to P782) .....	194
SmartLinx Hardware Testing (P790 to P795) .....	197
Echo Processing (P800 to P807) .....	199
Advanced Echo Processing (P815 to P825) .....	203
Advanced TVT Adjustment (P830 to P835) .....	207
Advanced Shot Adjustment (P840 to P852) .....	212
Test (P900 to P913) .....	215
Measurement (P920 to P927) .....	218
Master Reset (P999) .....	221
<b>Appendix A: Index Types</b> .....	<b>223</b>
Index types .....	223
<b>Appendix B: Technical Reference</b> .....	<b>224</b>
Transmit Pulse .....	224
Echo Processing .....	224
TVT (Time Varying Threshold) curves .....	225
Auto False-Echo Suppression .....	225
Distance Calculation .....	226
Sound Velocity .....	226
Scanning .....	227
Volume Calculation [MR 200] .....	227
Universal, Curved [MR 200] .....	228
Flow Calculation .....	228
Universal, Linear [MR 200] .....	229
Universal, Curved [MR 200] .....	229
Maximum Process Speed .....	230
<b>Appendix C: Troubleshooting</b> .....	<b>231</b>
Common Problems Chart .....	231
Noise Problems .....	232
Determine the Noise Source .....	232
Non-Transducer Noise Sources .....	233
Common Wiring Problems .....	233
Reducing Electrical Noise .....	233
Reducing Acoustical Noise .....	233
Measurement Difficulties .....	234
Flashing LOE Display .....	234
Adjust Transducer Aiming .....	234
Increase Failsafe Timer Value .....	235
Install a Transducer with a Narrower Beam.....	235
Use Dolphin Plus to Debug Echo.....	235
Fixed Reading .....	235

Obstructions in the Sound Beam .....	235
Nozzle Mountings .....	235
Set the MultiRanger to Ignore the Bad Echo .....	236
Wrong Reading .....	236
Types of Wrong Readings .....	236
Liquid Splashing .....	236
Adjust the Echo Algorithm .....	236
Transducer Ringing .....	237
Unit Repair and Excluded Liability .....	238
<b>Appendix D: Pump Control Reference .....</b>	<b>239</b>
Pump Control Options .....	239
Pump Groups .....	239
Pump by Rate [MR 200] .....	239
Pump Control Algorithms .....	239
Fixed Duty Assist (P111 = 50) .....	240
Fixed Duty Backup (P111 = 51) [MR 200] .....	240
Alternate Duty Assist (P111 = 52) .....	241
Alternate Duty Backup (P111 = 53) [MR 200] .....	241
Service Ratio Duty Assist (P111 = 54) [MR 200] .....	242
Service Ratio Duty Backup (P111 = 55) [MR 200] .....	243
First In First Out (FIFO) (P111 = 56) [MR 200] .....	243
Pump by Rate (P121) [MR 200] .....	243
Other Pump Controls [MR 200] .....	243
<b>Appendix E: Updating Software .....</b>	<b>245</b>
Updating Software .....	245
<b>Appendix F: Upgrading .....</b>	<b>246</b>
Mounting a MultiRanger 100/200 .....	246
Connecting the Transducer .....	246
Coaxial Transducer Extension .....	246
Connecting a transducer with RG62 coaxial extension cable.....	247
MultiRanger Plus to MultiRanger 100/200 Parameters .....	248
<b>Appendix G: Conduit Entry for Class 1, Div 2 Applications .....</b>	<b>249</b>
<b>Appendix H: Hazardous Area Installations .....</b>	<b>251</b>
<b>Appendix J: Software Revision History .....</b>	<b>253</b>
MultiRanger 100 .....	253
MultiRanger 200 .....	256
<b>Programming Charts .....</b>	<b>259</b>

# The MultiRanger 100 and 200

---

The MultiRanger is available in two models, MultiRanger 100 and MultiRanger 200, and is designed for a variety of applications:

- water and wastewater
- storage tanks, for measuring liquids, slurries, and solids
- hoppers, ore bunkers, flotation cells

## MultiRanger 100

The MultiRanger 100 is a single or dual-point level, one, three, or six relay measurement device. It is equipped with digital communications and offers the latest in echo processing technology and diagnostic features.

## MultiRanger 200

The MultiRanger 200 is a single or dual-point, three or six relay device that offers both level and volume measurement. It has Open Channel Monitoring capabilities, a larger number of advanced pump control algorithms, and is equipped with digital communications. It offers the latest in echo processing technology and diagnostic features.

## The Manual

### Notes:

- This product is intended for use in industrial areas. Operation of this equipment in a residential area may cause interference to several frequency based communications.
- Please follow the installation and operating procedures for a quick, trouble-free installation and to ensure the maximum accuracy and reliability of your MultiRanger.

The manual provides instruction for both MultiRanger 100 and MultiRanger 200 models. For your convenience, the manual uses MultiRanger 100 features as its standard content. Additional MultiRanger 200 features are clearly marked.

The manual is designed to help you get the most out of your MultiRanger, and it provides information on the following:

- How to program the unit
- Example applications
- Principles of operation
- Parameter values
- Parameter uses
- Outline diagrams
- Wiring diagrams
- Installation requirements
- Modbus<sup>® 1</sup> register mapping
- Modem configuration









1. Modbus is a registered trademark of Schneider Electric.

If you have any questions, comments, or suggestions about the manual contents, please email us at [techpubs.smpi@siemens.com](mailto:techpubs.smpi@siemens.com).

For the complete library of Siemens Milltronics manuals, go to [www.siemens.com/processautomation](http://www.siemens.com/processautomation).

## Manual Symbols

Please note their use carefully.

	Alternating Current
	Direct Current
	Earth (ground) Terminal
	Protective Conductor Terminal
	Caution (refer to instructions)
	Infra-red communication port on front of instrument
	RJ-11 communications port
	No co-axial cable connections

## Configuration Examples

The configuration examples used in this manual illustrate the versatility of the MultiRanger. Because there is often a range of ways to approach an application, other configurations may also apply.

In all examples, substitute your own application details. If the examples do not apply to your application, check the applicable parameter reference for the available options.

Should you require more information, please contact your Siemens Milltronics representative. For a complete list of Siemens Milltronics representatives, go to [www.siemens.com/processautomation](http://www.siemens.com/processautomation).

# Specifications

---

## Power

### AC version

- 100-230 V AC  $\pm$  15%, 50 / 60 Hz, 36 VA (17W)<sup>1</sup>
- fuse: F3: 2 AG, Slow Blow, 0.375A, 250V

### DC version

- 12-30 V DC, 20W<sup>1</sup>
- fuse: F3: 2 AG, Slow Blow, 2A, 250V

### Transmitter fuse

- F1: Belling Lee, L754, 4000A HRC, ceramic type, 100mA, 250V

### Temperature Sensor fuse

- F2: Belling Lee, L754, 4000A HRC, ceramic type, 50mA, 250V

## Mounting

### Location

- indoor / outdoor

### Altitude

- 2000 m max.

### Ambient temperature

- -20 to 50 °C (-5 to 122 °F)

### Relative humidity

- Wall Mount: suitable for outdoors (Type 4X / Nema 4X, IP65 Enclosure)
- Panel Mount: suitable for outdoors (Type 3 / Nema 3, IP54 Enclosure)

### Installation category

- II

### Pollution degree

- 4

---

<sup>1</sup>: Power consumption is listed at maximum.

## Range

- 0.3 m (1 ft) to 15 m (50 ft), dependent on transducer

## Accuracy

- 0.25% of maximum range or 6 mm (0.24"), whichever is greater

## Resolution

- 0.1% of program range<sup>1</sup> or 2 mm (0.08"), whichever is greater

## Memory

- 1 MB static RAM with battery backup
- 512 kB flash EPROM

## Programming

### Primary

- handheld programmer

### Secondary

- PC running SIMATIC PDM
- PC running Dolphin Plus software

## Display

- back lit LCD

## Temperature Compensation

- Range: -50 to 150 °C (-58 to 302 °F)

### Source

- integral transducer sensor
- TS-3 temperature sensor
- programmable fixed temperature

## Temperature Error

### Sensor

- 0.09 % of range

---

<sup>1</sup>. Program range is defined as the empty distance from the face of the transducer (P006) plus any range extension (P801).

## Fixed

- 0.17 % per °C deviation from programmed value

## Outputs

### Transducer drive

- 315 V peak

### mA Analog

MultiRanger 100/200:

Single or Dual point versions include two mA outputs

- 0-20 mA
- 4-20 mA
- 750 ohm maximum
- Resolution of 0.1%
- Isolated

### Relays<sup>1)</sup>

- One:
  - 1 control
- Three:
  - 2 control
  - 1 alarm control
- Six:
  - 4 control
  - 2 alarm control
- All relays rated:
  - 5A at 250 V AC, non-inductive
  - 5A at 30 V DC, non-inductive

### Control Relays

- 1, 2 or 4 Form **A**, **NO** relays (numbers 1, 2, 4, 5)

### Alarm Relay

- 0, 1 or 2 Form **C**, **NO**, or **NC** relay (numbers 3, 6)

### Communication

- RS-232 running Modbus RTU and ASCII via RJ-11 connector
- RS-485 running Modbus RTU and ASCII via terminal blocks

### Optional

- SmartLinX<sup>®</sup> compatible

---

1. All relays are certified only for use with equipment that fails in a state at or under the rated maximums of the relays.

## Inputs

### **mA (analog) (1) [MR 200 only]**

- 0-20 or 4-20 mA, from alternate device, scalable

### **Discrete (2)**

- 10-50 V DC switching level
- logical 0 = < 0.5 V DC
- logical 1 = 10 to 50 V DC
- 3 mA maximum draw

## Enclosure

### **Wall Mount**

- 240 mm (9.5") x 175 mm (6.9"). Width dimension includes hinges.
- Type 4X / NEMA 4X / IP 65<sup>1</sup>
- Polycarbonate

### **Panel Mount**

- 278 mm (10.93") x 198 mm (7.8") Width dimension includes flange.
- Type 3 / Nema 3 / IP54
- Polycarbonate

## Weight

- Wall mount: 1.37 kg (3.02 lb)
- Panel mount: 1.5 kg (3.3 lb)

## Approvals

- See product nameplate

## Compatible Transducers

- Echomax series and STH series

## Transducer Frequency

- 44 kHz

---

<sup>1</sup>. For watertight applications, use only approved, suitable size hubs in the enclosure's conduit holes.



## Cable

- Do not use coaxial cable for transducer (see General Appendix F: Upgrading on page 246 for more information)
- transducer and mA output signal to be 2 copper conductors, twisted with shield/drain wire, 300 Vrms, 0.324 - 0.823 mm<sup>2</sup> (22 - 18 AWG), nominal capacitance between adjacent conductors @ 1kHz = 62.3 pF/m (19 pF/ft). Nominal capacitance between conductor and shield @ 1kHz = 108.3 pF/m (33 pF/ft) (Belden® <sup>1</sup> 8760 is acceptable)
- 365 m maximum

**Note:** The MultiRanger is to be used only in the manner outlined in this instruction manual or protection provided by the equipment may be impaired.

---

<sup>1</sup>. Belden is a registered trademark of Belden Wire & Cable Company.

# Installation

---

## Notes:

- Installation must only be performed by qualified personnel, and in accordance with local governing regulations.
- This product is susceptible to electrostatic shock. Follow proper grounding procedures.



**All field wiring must have insulation suitable for at least 250 V.**



**Hazardous voltage present on transducer terminals during operation.**



**DC terminals shall be supplied from an SELV source in accordance with IEC 1010-1 Annex H.**

- The non-metallic enclosure does not provide grounding between conduit connections. Use grounding type bushings and jumpers.

## Mounting

### Mounting Locations

#### Recommended

- Ambient temperature is always within -20 to 50 °C (-5 to 122 °F)
- MultiRanger display window is at shoulder level, unless most interaction is through a SCADA system
- Easy access for hand programmer is provided
- Cable length requirements are minimal
- Mounting surface is free from vibration
- Leave is sufficient room to swing unit lid open and have clear access.
- A place for a laptop computer is provided for on-site Dolphin Plus configuration

#### Avoid

- Exposure to direct sunlight. (Provide a sun shield to avoid direct sunlight.)
- Proximity to high voltage/current runs, contacts, SCR or variable frequency motor speed controllers

# Mounting Instructions

The wall mount and panel mount units install differently. Please follow the specific instructions for your unit.

**Note:** When routing cable through a conduit, please follow the Cable Routing instructions on page 10 before mounting the MultiRanger.

## Wall Mount

### Enclosure Dimensions

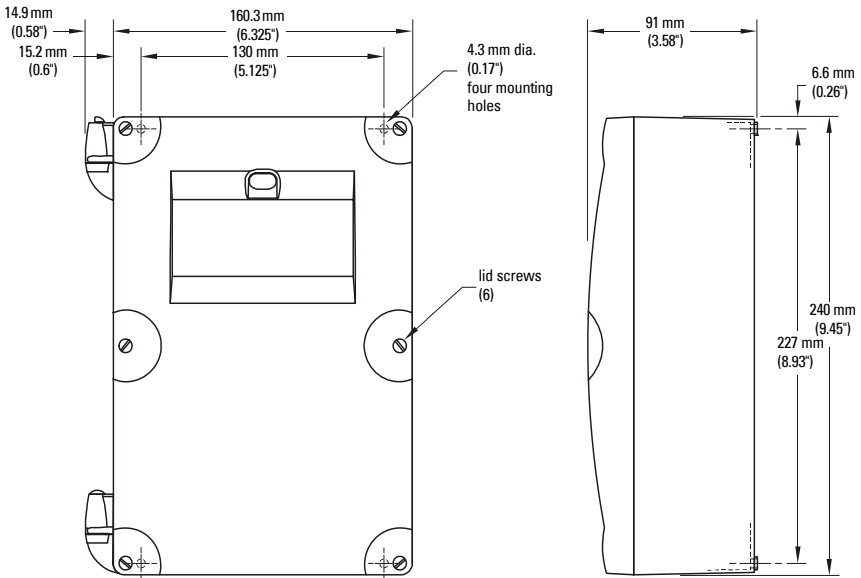

### Mounting the Enclosure

1. Remove the lid screws and open the lid to reveal the mounting screw holes.
2. Mark and drill four holes in the mounting surface for the four screws (customer supplied).
3. Fasten with a long screwdriver.

#### Please note:

- Recommended mounting: directly to wall or to electrical cabinet back panel
- Recommended mounting screws: #6
- If alternate mounting surface is used, it **MUST** be able to support four times the weight of the unit.

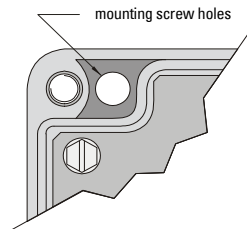

## Cable routed through a conduit:

1. Remove the four mounting screws holding the motherboard to the enclosure.
2. Be careful not to damage the electronics with static electricity. Remove the motherboard from the enclosure by pulling the board straight out.
3. Drill the required cable entry holes. Make sure conduit holes do not interfere with the lower areas on the terminal block, circuit board, or SmartLinX card.
4. Attach the conduit to the enclosure using only approved suitable size hubs for watertight application.
5. Reinstall the motherboard with the mounting screws.

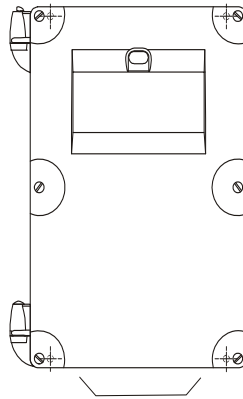

suitable location for conduit entrances

**Note:** For conduit locations and assembly for hazardous mounting in Class 1 Div 2 applications, please see Drawing 23650314 in *Appendix G: Conduit Entry for Class 1, Div 2 Applications* on page 249.

## Cable exposed and entering through the cable glands:

1. Unscrew the glands and attach them loosely to the enclosure.
2. Thread the cables through the glands. Ensure the power cable is kept separated from the signal cables and then wire the cables to the terminal blocks.
3. Tighten the glands to form a good seal.

**Note:** Where more holes are required than are supplied in the enclosure, follow the *Cable routed through a conduit* steps.

# Panel Mount

Installing the panel mount unit requires making a cutout in the panel. The dimensions for the cutout are provided in the illustration below. A full size cutout template is provided with your unit or may be downloaded from [www.siemens.com/processautomation](http://www.siemens.com/processautomation).

## Cutout Dimensions

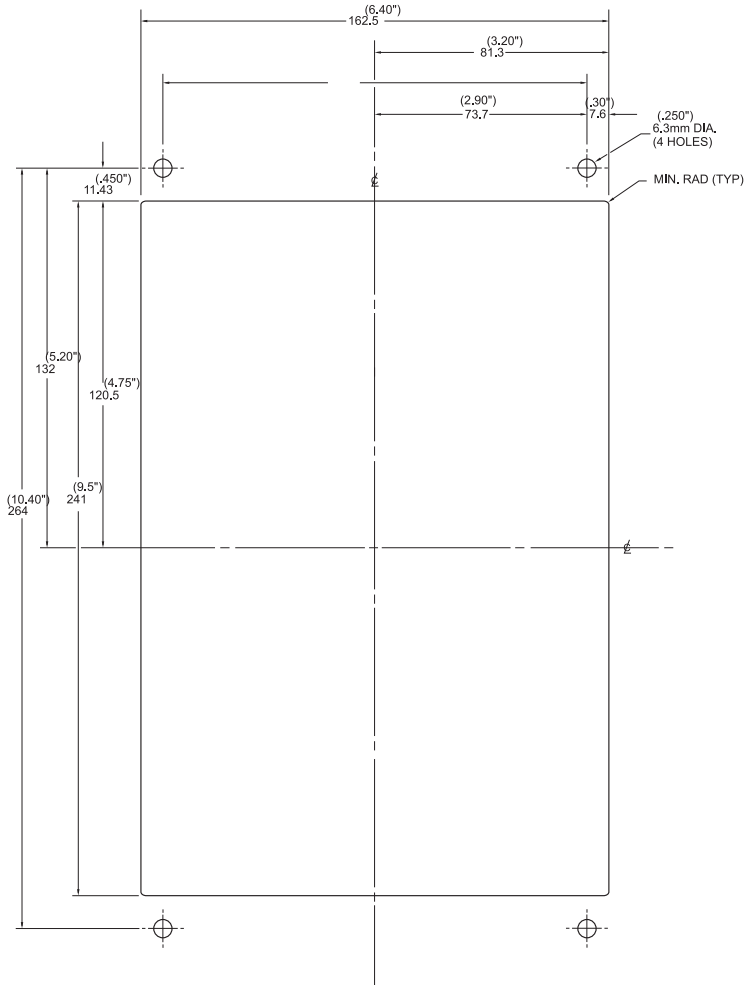

## Cutout Instructions

1. Select a place for the unit and fasten the template onto the panel (use tape or tacks).
2. Drill the four fastener holes.
3. Make the cutout using the appropriate tools.
4. Mount unit according to the instructions in this manual.

## Panel Mount Dimensions

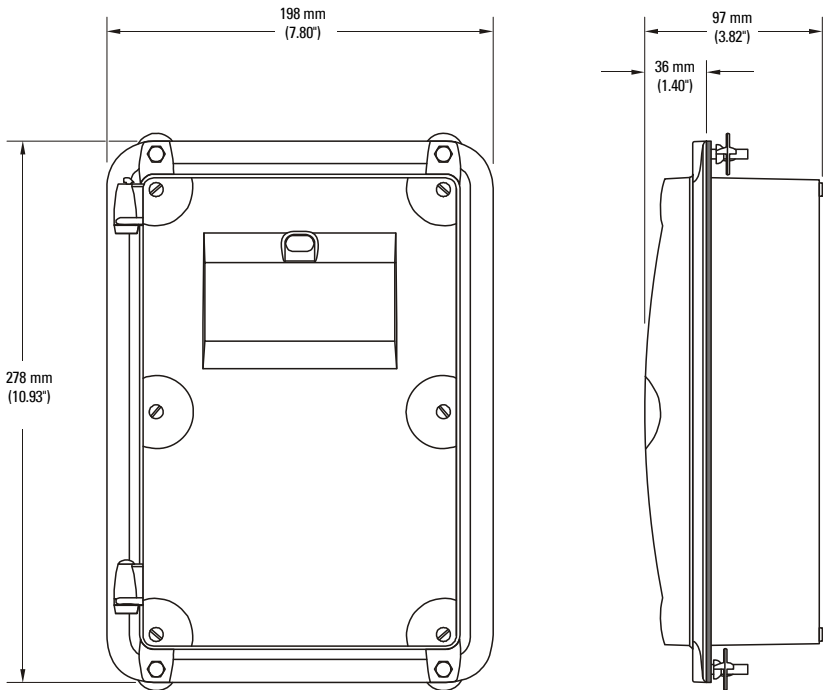

## Mounting the Enclosure

Once cutout is complete and mounting holes are drilled, follow these steps:

1. Remove lid from unit by undoing the six lid screws and lifting it off its hinges.
2. Remove the four screws holding the motherboard to the enclosure.
3. Be careful not to damage the electronics with static electricity. Remove the motherboard from the enclosure by pulling the board straight out.
4. Drill the required cable entry holes. Be sure to compensate for panel door dimensions and make sure conduit holes do not interfere with the lower areas on the terminal block, circuit board, or SmartLinX card.
5. Replace board and fasten the four screws.
6. Place the unit into the panel and insert hexagonal fasteners through bevel slots and predrilled panel holes.
7. Fasten with wingnuts and hand tighten.
8. Add conduit or glands and wire as required, then replace the lid.

### Helpful hint:

- Use tape to hold hexagonal heads in slots while attaching wingnuts.

# MultiRanger Board

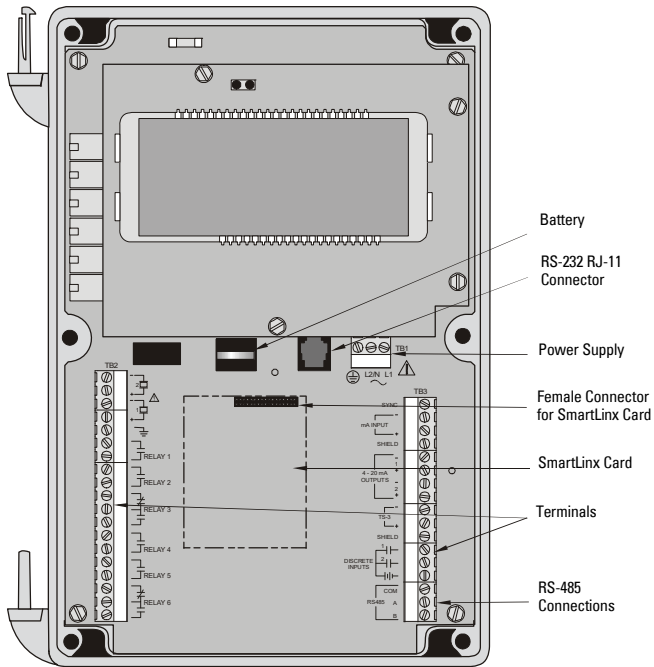

## Installing the Battery

The battery (Rayovac BR2032) has a ten-year life expectancy. Please note the life expectancy may be reduced by ambient temperature. If the unit loses external and battery power, a capacitor will power the RAM for about ten minutes.



**Disconnect power before replacing the battery.**

### Installation Steps

1. Open the enclosure lid.
2. Slide the battery into the holder. Be sure to align the + and – terminals correctly.
3. Close and secure enclosure lid.

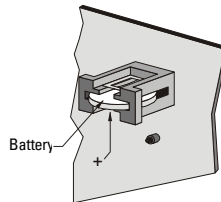

**Note:** All parameter values are written to the EEPROM once every hour. The battery is used to backup Standard Data Logging parameters (P300-P321) between writes, in case of power failure.

# Installing SmartLinx Card

SmartLinx cards are generally pre-installed. If unit does not have a SmartLinx card, follow these steps to install one.

1. Align card with the two mounting posts and then press-fit with the female connector.
2. Use the screws supplied with the card to attach it to the mounting posts.
3. Wire in the SmartLinx card according to SmartLinx Manual.



# Wiring

**Please note:**

- Verify that all system components are installed in accordance with instructions.
- Connect all cable shields to the MultiRanger Shield Terminals. Avoid differential ground potentials by not connecting cable shields to ground (earth) anywhere.
- Keep exposed conductors on shielded cables as short as possible to reduce noise on the line caused by stray transmissions and noise pickup.

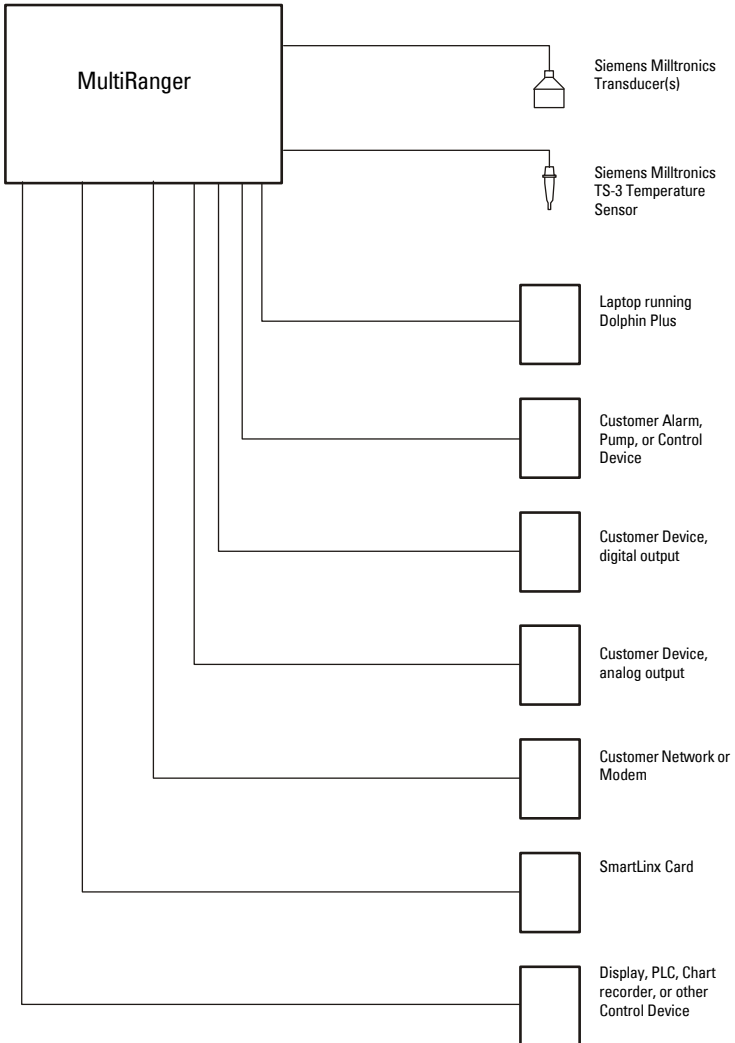

# Terminal Board

The terminal board on the MultiRanger allows all inputs and outputs to be connected simultaneously.

**Note:** Recommended torque on terminal clamping screws.

- 0.56 - 0.79 Nm
- 5 - 7 in.lbs

**Please do not overtighten the screws.**

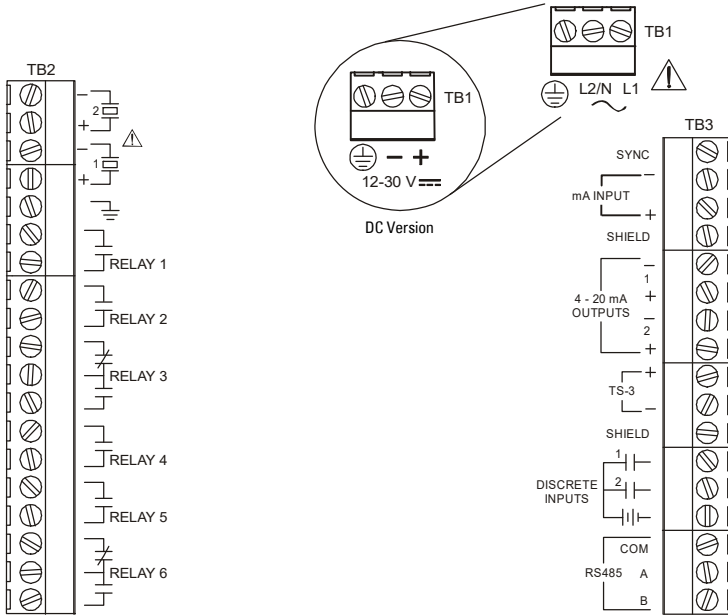

## Cables

The MultiRanger transceiver requires a shielded two-wire connection to the transducer.

Connection	Cable Type
mA input and mA output sync, Temperature sensor, discrete input, dc input Transducer	2 copper conductors, twisted, with shield <sup>1</sup> /drain wire, 300V 0.324 - 0.823 mm <sup>2</sup> (22 - 18 AWG) <b>Maximum length: 365 m</b>
	<b>Do not use a coaxial transducer cable extension with the MultiRanger. Electrical noise interference affects performance.</b>
Relay output AC input	Relay to be copper conductors per local requirements to meet 250 V 5A contact rating.

1. Preferred shielding is braided screen.

# Transducers



**Warning: Hazardous voltage present on transducer terminals during operation.**

**Run the transducer cable in a grounded metal conduit, separate from other wiring (except TS-3 temperature sensor wiring, if applicable).**

## Notes:

- Do not use coaxial cable because of electrical noise interference
- Do not connect the shield and white transducer wires together; wire to separate terminals
- Disregard older transducer manuals that recommend these practices

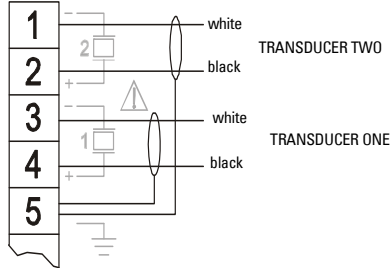

A 0.1  $\mu\text{F}$  (100V or greater) capacitor is included with the MultiRanger for retrofitting old MultiRanger Plus installations. Please see *MultiRanger 100/200 Installation (for retrofitting MultiRanger Plus Installations)* on page 247.

# Relays

Relay contacts are shown in the de-energized position. All relays are handled identically and can be configured as positive or negative logic using P118.

## Relay Ratings

- four Form A, NO relays (1,2,4,5)
- two Form C, NO or NC relays (3,6)
- 5A at 250Vac, non-inductive

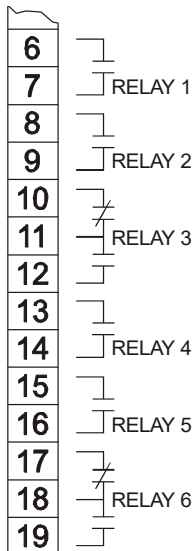

## Power Failure

Relays 1, 2, 4, and 5 are normally open and will fail in the normal state.

Relays 3 and 6 can be wired either normally open or normally closed, and will fail in their de-energized states.

# Temperature Sensor

Accurate temperature readings are critical to accurate level measurements because the speed of sound changes, depending on air temperature, and all Siemens Milltronics Echomax and ST-H transducers have an internal temperature sensor.

If the following conditions apply, a separate TS-3 temperature sensor will ensure optimum accuracy:

- the transducer is exposed to direct sunlight (or other radiant heat source)
- the transducer face and monitored surface temperature differs
- faster response to temperature changes is required

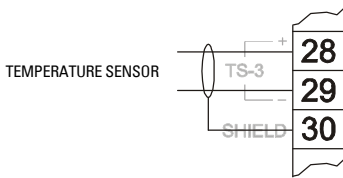

## Note

Use a T-S3 Temperature Sensor only. Leave terminals open (unused) if TS-3 is not deployed.

## mA Input [MR 200 only]

For more information, consult the Transducer (P004) and mA Input Parameters (P250, P251, and P252) in the parameter reference section.

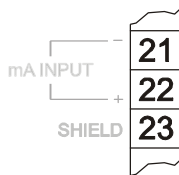

## mA Output

For more information, consult the mA output parameters (P200 to P219) in the parameter reference section.

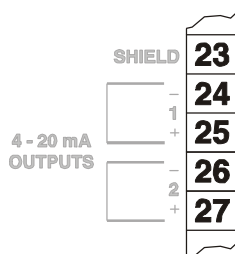

# Level System Synchronization

**Note:** The MultiRanger 100/200 CANNOT be synchronized with the MultiRanger Plus or the HydroRanger.

When using multiple ultrasonic level monitors, be sure to run the transducer cables in separate grounded metal conduits.

When separate conduits are not possible, synchronize the level monitors so that no unit transmits while another is waiting for echo reception.

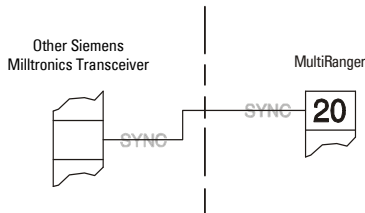

## Synchronizing with another MultiRanger 100/200, or other Siemens Milltronics instruments (DPL+, SPL, XPL+, LU01, LU02, LU10, LUC500, Hydro+, EnviroRanger, MiniRanger):

- Mount the level monitors together in one cabinet
- Use a common power (mains) supply and ground (earth) for all units
- Interconnect the SYNC terminals of all level monitors
- Set parameter *P726 Level System Sync* on page 190.
- Contact Siemens Milltronics or your local distributor. Go to [www.siemens.com/processautomation](http://www.siemens.com/processautomation).

## Power

### Important!

Before applying power to the MultiRanger for the first time, ensure any connected alarm/control equipment is disabled until satisfactory system operation and performance is verified.

### Notes for AC power connections

- The equipment must be protected by a 15 A fuse, or circuit breaker in the building installation.
- A circuit breaker or switch in the building installation, marked as the disconnect switch, must be in close proximity to the equipment and within easy reach of the operator.

**Note:** Make sure unit is connected to a reliable ground.

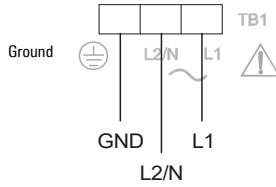

## Digital Communications

Wiring the MultiRanger for communications allows it to be integrated into a full SCADA system or an industrial LAN.

The MultiRanger can also be directly connected to a computer running Dolphin Plus.

## RS-232 Serial Connection

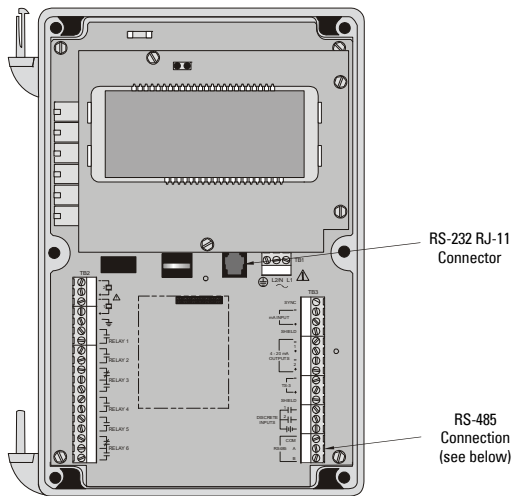

## RS-485 Serial Connection

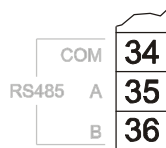

# Discrete Inputs

Discrete inputs have a positive and negative terminal. Requires an external power supply.

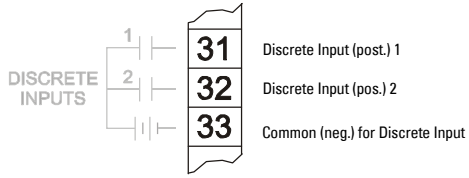

# Operating the MultiRanger

The MultiRanger has two modes of operation: **RUN** and **PROGRAM**.

## RUN Mode



In RUN mode, the MultiRanger detects material level and provides control functions. The MultiRanger automatically starts in RUN mode when power is applied.

System status is shown on the unit's LCD, or on a remote communications terminal.

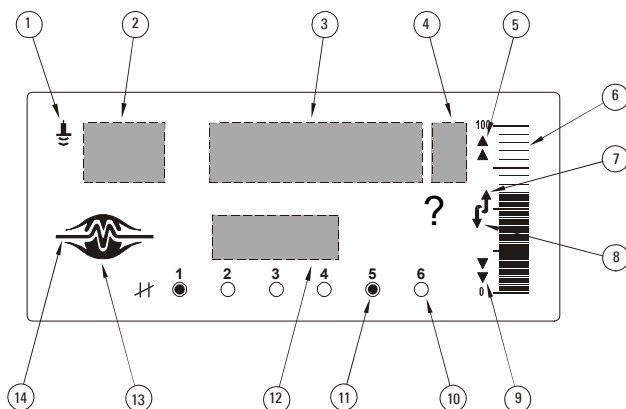
### Display







### Indicator Functions

	<b>RUN Mode</b>	<b>PROGRAM Mode</b>
1	index type (see below)	index type (see next table)
2	index	index
3	primary reading	parameter value
4	units	units
5	hi and hi hi alarm designation	auxiliary function
6	level display	n/a
7	filling display	scroll access tag
8	emptying display	scroll access tag
9	lo and lo lo alarm designation	n/a
10	relay # programmed	relay # programmed
11	relay # activated	relay # activated
12	auxiliary reading	parameter number
13	normal operation: 	n/a
14	failsafe operation: 	n/a















## Icons indicating index type (Item 1) edited in PROGRAM mode:

Icon	Index Type
	measurement point or transducer
	relay
	secondary index
	mA input or output

## Readings in RUN Mode

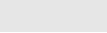
Change the displayed values with the keys on the hand programmer. All readings are shown in the Auxiliary field, except for the totalizer and P920.

Key	Function	P#
	Toggle Readings between percent and units: <ul style="list-style-type: none"> <li>Level: 0 – 100%</li> <li>Space or Distance:<sup>1</sup> 100% – 0</li> </ul>	P920
	Accumulated pump running hours <sup>2</sup> for numbered pump.	P310
	Hold number key for five seconds to display the number of accumulated pump starts <sup>2</sup> for numbered pump.	P311
	Eight-digit totalizer, uses index and reading areas, press again to toggle, P737 sets default. Used for OCM and Pumped Volume.	P322 P323 P920
	Head measurement	P926
	Instantaneous flow based on head (OCM)	P925
	mA Output value	P203
	Temperature	P664
	Rate of level change	P707
	Failsafe Time Left (in %). When the Reading is updated, this value (Auxiliary Reading) resets to 100 and begins to decrease until the next valid measurement is made. If the Failsafe Time Left reaches 0, <b>LOE</b> flashes in the display.	
	Hold for four seconds to show echo confidence	P805
	Display the value of the entered parameter which is global or indexed by transducer	
	Auxiliary reading displays parameter specified in P731	P731
	Distance	P923

- Distances less than 0.3 m (1 ft) from the transducer face cannot be measured reliably. Therefore, a 0% reading is not possible during **Distance** operation.
- If the associated relay is programmed for pump control.

## Status Parameters

Status parameters give the operating status of the MultiRanger. You can access parameters with the hand programmer (see page 32) or with Dolphin Plus (see page 27). Remote SCADA system access is also possible.

Parameter		Values
P203	mA Output Value	0 to 22 – Current mA output
P254	Scaled mA Input Value	0 to 9999 – Current mA input after scaling
[MR 200 only]		
P275	Scaled Discrete Input Value	Shows current value of discrete input, values vary by DI function
P322	LCD Total Low	The last four digits of the totalizer
[MR 200 only]		
P323	LCD Total High	The first four digits of the totalizer
[MR 200 only]		
P341	Run Time	The number of days the MultiRanger has been operating
P342	Start Ups	The number of times power has been cycled
P664	Temperature	Current temperature measured by transducer
P707	Rate Value	Current rate of material level change
P708	Volume Rate Display	Current rate of material volume change
[MR 200 only]		
P729	Scan Time	Seconds since last level scan
P806	Echo Strength	Strength of primary echo
P920	Reading Measurement	Current primary reading
P921	Material Measurement	Current level from P007–Span
P922	Space Measurement	Empty space above the material level
P924	Volume Measurement	Current volume value, if programmed
[MR 200 only]		
P925	Flow Measurement (OCM)	Current flow value, if OCM programmed
[MR 200 only]		
P926	Head Measurement (OCM)	Current level, if OCM programmed
[MR 200 only]		
P927	Distance Measurement	Distance from transducer face to material

# Controlling the Display

RUN mode provides numerous parameters and variables that you can track on the display (see *Display* on page 22).

The LCD displays **EEEE** if a value is too long.

## Adjusting the primary reading for four-digit LCD readout:

Parameter		Action
P060	Decimal Position	Sets maximum number of decimals
P061	Convert Reading	Scales the reading to fit
P062	Offset Reading	Shifts the reading up or down by a fixed amount

### Example

To reference the displayed level to sea level, enter the distance in Units (P005), between Empty (P006) and sea level. (Enter a negative value if Empty is below sea level.)

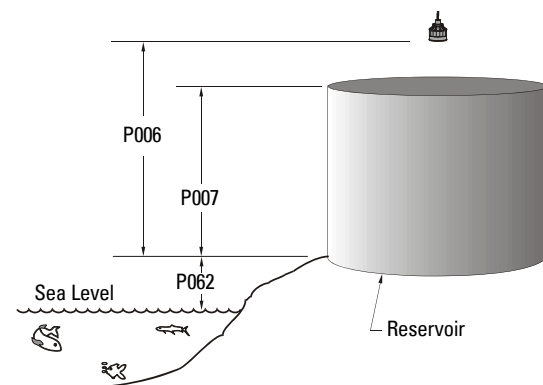

P062 is the distance between sea level and Empty.

## Auxiliary Reading

The Auxiliary Reading area of the LCD displays parameter values while leaving the primary reading on screen.

**Note:** The parameters shown in the auxiliary reading field are indexed as follows:

- global
- by transducer
- by level

## Setting the Default Auxiliary Reading

To maintain a constant variable display in the auxiliary reading area, set the default.

### Example:

To leave the level reading on the screen and view the echo confidence in the auxiliary reading field, set the following parameter:

Parameter	Index	Value	Description
P730	G	805	Auxiliary field defaults to P805

## Setting a Specific Auxiliary Reading

To display a second auxiliary reading, press  in RUN mode.

**Example:** To set  to display current temperature, go to P731:

Parameter	Index	Value	Description
P731	G	912	Shows P912–Transducer Temperature

## Multiple Readings [MR 200 only]

During **differential** or **average** operation (P001 = 4 /5), the display scrolls sequentially through Point Numbers 1, 2, and 3. Point 3 is the difference between (or average of) Points 1 and 2.

### Changing Number Scrolling Speed

Parameter	Index	Value	Description
P732	G	5	Hold each value for 5 seconds

See *Parameter Indexing* on page 37. All the instructions in the following procedures apply to the hand programmer and assume that the MultiRanger is activated.



# PROGRAM Mode

The MultiRanger is programmed by setting its parameters to match your specific application. Most parameters are indexed, allowing you to set the parameter to specific conditions and to more than one input or output. When the MultiRanger is in PROGRAM mode, you can change these parameter values and set operating conditions.

Please refer to the *Parameter Reference* section on page 117 for a full listing and explanations of parameter values.

The MultiRanger's primary programming is by the hand programmer. Other access is available through Dolphin Plus software (purchased separately).

## Notes

- To activate PROGRAM from RUN mode, press PROGRAM  and then DISPLAY 
- The display briefly reads ---- while the measurement reading is verified. Reading level and other data is displayed and programmed relays are operated.
- Placing a programmed unit that is in normal operation into PROGRAM mode de-energizes all control relay outputs. Be sure to bypass the MultiRanger while programming it.

## Starting PROGRAM Mode

### Hand Programmer

The hand programmer gives you direct access to the MultiRanger.

Aim the hand programmer and press PROGRAM key.

#### Notes:

- The battery in the programmer is not replaceable.
- The hand programmer is ordered separately from Siemens Milltronics

For your convenience, the programmer has a magnetic mounting strip on the back. Keep programmer nearby for easy access.

Point the programmer at the IR port above the display and press the keys.

Unless otherwise noted, each valid key press should produce a change in the LCD. Verify when programming the unit.

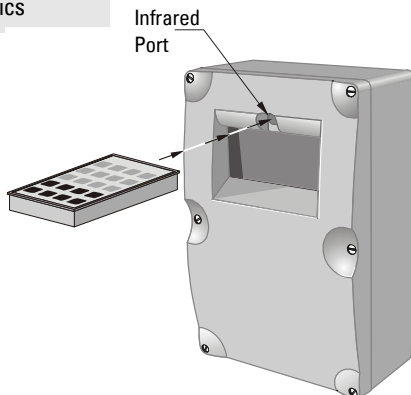

## Programmer Keys

Keys	Programming Mode	Run Mode
	1	8-digit Totalizer (toggle) [MR 200 only]
	2	Pump Running Time
	3	Head [MR 200 only]
	4	Flow based on Head [MR 200]
	5	mA Output
	6	Temperature
	7	Rate of Change
	8	Failsafe Time Left
	9	N/A
	0	N/A
	Decimal Point (TVT left)	Parameter Value
	Negative Value (TVT right)	Material Level (P731)
	Fire Transducer	Distance
	Run Mode	Program Mode (Key 1)
	Units or %	Units or % (Program Mode) (Key 2)
	Next Display Field	Pause Display Toggle
	Increase Value	Next Index
	Decrease Value	Previous Index
	Enter Value	
	Clear to Preset	

# Dolphin Plus

(compatible with product software versions 1.06 and earlier)<sup>1</sup>

Use Dolphin Plus software to configure, monitor, tune, and diagnose the MultiRanger from a PC or directly in the field with a laptop.

Dolphin Plus is easy to install and easy to use. Just load the software from the CD onto a desktop PC or Laptop and then set up or modify complete parameter configurations in a Windows<sup>®</sup> environment.

After configuration, you can edit parameters, upload and download parameter sets to and from disk, and use parameter sets saved from other instruments. You can also work with echo profiles for fine tuning without the need for special instruments. Built-in Quick Start features and Help files guide you through the entire process.

**Note:** Dolphin Plus is ordered separately from Siemens Milltronics.

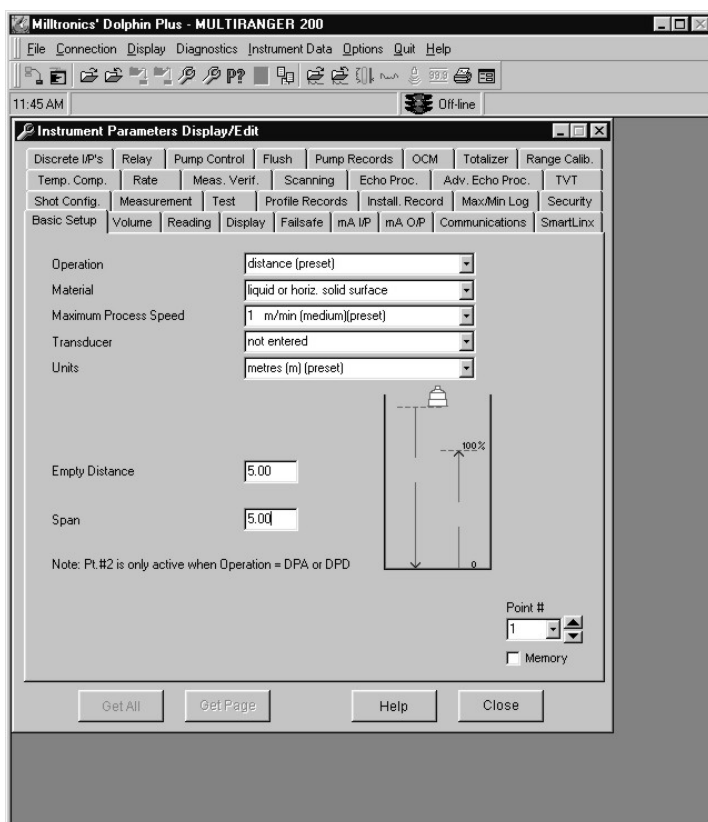

















1. See P900 for Software Revision Number.

2. Windows is a registered trademark of Microsoft Corporation.

## Dolphin Plus Toolbar Buttons

The toolbar buttons provide quick access to Dolphin Plus features.

Button	Action
	communicate with instrument—toggle online versus offline
	monitor communications
	send parameter set to instrument
	save parameter set to file
	open the quick start wizard
	open the tabbed parameters window
	find a parameter in the tabbed parameters window
	toggle PROGRAM mode and RUN mode
	open the reporting windows
	load an echo profile from a file
	save the current echo profile to a file
	open the vertical echo profile and tank mimic window
	open the horizontal echo profile window
	take a measurement with the current transducer
	open the reading values (distance measurement) window
	print current echo profile
	open the Echo Info Editor window



# SIMATIC Process Device Manager (PDM)

(compatible with product software versions 1.07 and later)<sup>1</sup>

SIMATIC PDM is a software package for parameterizing, commissioning, diagnosing and maintaining process devices. For the MultiRanger 100/200, SIMATIC PDM connects directly to the device using Modbus over Port 1 or Port 2.

The MultiRanger 100/200 comes with Port 1 set for communications to SIMATIC PDM.

SIMATIC PDM contains a simple process monitor of the process values, alarms and status signals of the device. Using SIMATIC PDM you can

- display,
- set,
- change,
- compare,
- check the plausibility of,
- manage, and
- simulate

process device data.

More information about SIMATIC PDM is available at [www.siemens.com/processinstrumentation](http://www.siemens.com/processinstrumentation): go to Products & Solutions > Products & Systems > Communication and Software > Process Device Manager. Please consult the operating instructions or online help for details on using SIMATIC PDM. An Application Guide on using MultiRanger 100/200 with PDM and Modbus is available on our website: [www.siemens.com/processautomation](http://www.siemens.com/processautomation).

## Device Description



To use Process Device Manager (PDM) with MultiRanger 100/200, you need the Device Description for MultiRanger 100/200, which will be included with new versions of PDM. You can locate the Device Description in **Device Catalog**, under **Sensors/Level/ Echo/ Siemens Milltronics**. If you do not see MultiRanger 100/200 under Siemens Milltronics, you can download it from our website: [www.siemens.com/processautomation](http://www.siemens.com/processautomation). Go to the MultiRanger product page and click Downloads. After downloading the DD file, you need to execute DeviceInstall.

---

<sup>1</sup>. See P900 for Software Revision Number.

# Activating the MultiRanger

All the instructions in the following procedures apply to the hand programmer and assume that the MultiRanger is activated.





1. Power the MultiRanger.
2. Point the programmer at the unit and press PROGRAM .
3. Press DISPLAY .

**Note:** Power up display



- Single Point Model
  - preset to display distance from the face of the transducer to the material
  - transducer selection is preset for the XPS-10
  - empty distance is preset to 5 m
- Dual Point Model
  - starts in an OFF state and does not take level measurements
  - to set up measurement, the quick start parameters must be configured
  - See Quick Start parameters on page 119

## Changing Parameters

**Note:** If Parameter Value alteration is not permitted, access the Lock parameter (P000) and enter the security code, (see Security below).

1. Starting in RUN mode, press PROGRAM  and then press DISPLAY  to put the unit into PROGRAM mode.
2. Press DISPLAY  to select the Parameter Number field.
3. Enter the Parameter Number (e.g. 110). After the third digit is entered, the parameter value is shown.
4. Enter the new value, and press ENTER . The MultiRanger interprets the value, either accepting or replacing it with a valid value.

### Helpful Hints

- For parameters P001 to P009, press a single digit (1–9) and then press DISPLAY  to show that parameter.
- The ? icon indicates that the MultiRanger has accepted the value but that it conflicts with other values entered. Double-check your programming.
- By default, the SCROLL arrows   show only the Quick Start parameters and any that have been changed.
- P733 sets all parameters to be scroll-accessed.

# Security

The Lock parameter P000 secures the MultiRanger against parameter changes via the handheld programmer. The unit can still be put into PROGRAM mode when locked, and parameter values can be viewed, but no parameter values can be changed.

When P000 is set to **1954**, programming is enabled. To disable programming, enter another value.

P000 (1954) is a fixed value password. Therefore, you should use other means to secure the MultiRanger if security is a concern.

## Simulation

P000 Lock also controls how simulations affect control relays. By default, control relays are unaffected by simulation levels. But if P000 is set to **-1**, they react to the simulated level. See *Parameters P925–P927* on page 220 for running a simulation.

# Using Units or Percent (%)

Many parameters can be viewed either in measurement units (P005) or as a percentage. View the parameter and then press MODE  to toggle between units and percentage. The LCD shows the selected measurement type, either units (m, ft) or percentage (%).

## MR 200 only:

Percentage is also available when showing flow and volume with 100%, based on the parameter that defines the maximum.

Measurement	Maximum
Volume	P051
Flow	P604

# Parameters Types

## View Only Parameters

Parameter values indicating status only. They cannot be altered.

## Global Values

Parameter values common to all inputs and outputs on the MultiRanger.

When a global parameter is accessed, the index display automatically disappears. When a non-global parameter is accessed, the index display reappears showing the last index number.

## Default Values

Parameter default values are indicated with an \* in the parameter tables.



### P000 Lock

Primary Index	Global		
Value	1954	*	OFF: programming permitted
	-1		Simulation Controls (relays energize based on simulated level)
	other		ON: Lock activated and programming not permitted via the handheld programmer

The asterisk identifies **1954** as the default value.

## Parameter Reset

Returning a parameter to factory default.

1. Display the appropriate parameter number.
2. Display the appropriate index value (if required).
3. Press CLEAR .
4. Press ENTER .

### Master Reset (P999)

Returns all parameters to original values.

Use Conditions:



- before initial system installation
- following a software upgrade

If complete reprogramming is required, use Dolphin Plus to store and retrieve parameters.

When the dual point option is enabled, P999 is indexed by transducer. Use index **00** to reset the entire MultiRanger.

## Display Readout

The following readouts are shown when the MultiRanger cannot display a number.

Display	Definition
	Parameter has not been set
	All values not same when viewing index <b>0</b>
	Value too large for four-digit display

## Changing Parameters(Dolphin Plus)

The other method for changing parameter values is with Dolphin Plus software. It lets you access the MultiRanger from a PC or on site with a laptop and change MultiRanger parameters.

Most examples in this manual use the icons from the hand programmer but nearly all functions are also available through Dolphin Plus.

**Instrument Parameters Display/Edit**

Discrete IP's | Relay | Pump Control | Flush | Pump Records | OCM | Totalizer | Range Calib.  
 Temp. Comp. | Rate | Meas. Verif. | Scanning | Echo Proc. | Adv. Echo Proc. | TVT  
 Shot Config. | Measurement | Test | Profile Records | Install. Record | Max/Min Log | Security  
 Basic Setup | Volume | Reading | Display | Failsafe | mA I/P | mA O/P | Communications | SmartLinux

Operation: distance (preset)  
 Material: liquid or horiz. solid surface  
 Maximum Process Speed: 1 m/min (medium)(preset)  
 Transducer: not entered  
 Units: metres (m) (preset)

Empty Distance: 5.00  
 Span: 5.00

Note: Pt.#2 is only active when Operation = DPA or DPD

Point #: 1  
 Memory

Get All | Get Page | Help | Close

## Parameter Indexing

Parameters are indexed when they apply to more than one input or output. The index value defines the input/output for that parameter. Indexed parameters contain a value for each index, even if that index is not used.

### MultiRanger Display



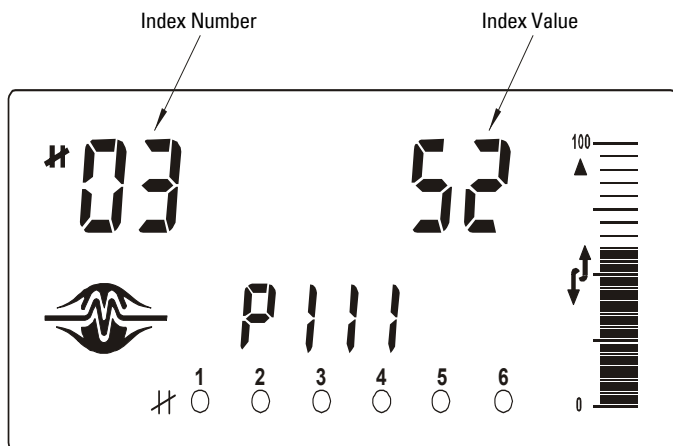

The index number and the index values are displayed above the parameter indicator on the LCD.



#### Notes

- Transducers are always indexed when the dual point option is enabled.
- An indexed transducer is commonly referred to as a Point (short for 'Measurement Point'). **Point Number** refers to indexed transducers.
- To set all indexed values for a parameter to the same value, use index **0**.
- **MR 200 only:** Transducer parameters are indexed only if Operation (P001) is set to **Difference** (value=4) or **Average** (value=5) on a single point MultiRanger.

### Accessing a Parameter Index

1. Press DISPLAY  once to clear current parameter field.
2. Enter the new parameter number.
3. Press DISPLAY  twice.
4. Press the number of the required index. Or press ARROW keys   to scroll through the available values.

**Note:** For optimum performance, set values accurately for indexed parameters. Ensure that the correct index value is being changed for each parameter value.

# Primary and Secondary Indexes

**Primary Index:** relates to direct input or output and can refer to relays, communications ports, and other parameters. In parameters that allow secondary indexes, the primary index is often referred to as a **point**.

**Secondary Index:** relates to previously indexed parameters where the parameter requires a second index, permitting multiple values on an indexed input or output.

## Primary Index

**Example Setting:** P111[3] = 52

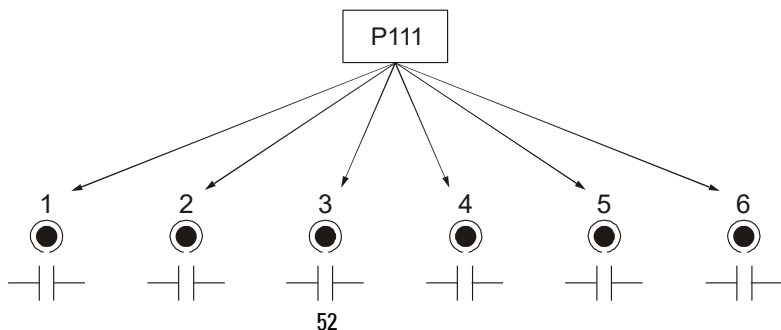



- P111 sets the Relay Control Function
- P111(3) = 52 sets Relay #3 to a value of 52.

## Secondary Index

Parameters with a secondary index permit multiple values for a primary index (point). For example, a volume calculation based on vessel characterization breakpoints requires a distinct set of breakpoints for each measured point.

Thus the primary index refers to the measurement point, and each secondary index refers to a characterization breakpoint value.

### Accessing a Secondary Index

1. Press MODE  and then press DISPLAY  to activate secondary index. The  icon appears under the index field.
2. Enter the secondary index, and then enter the values to set the secondary index.

### Example [MR 200 only]

P054 provides up to 32 breakpoint levels used with P055 (Volume Breakpoint) for universal volume calculation. The illustration indicates how you can set secondary indexes to specific functions.

A	B	C
P054 [1,6] = 2m	P054 [1,3] = 1.5m	P054 [1,1] = .75m
P054 [2,6] = 8m	P054 [2,3] = 5.5m	P054 [2,1] = 2.75m

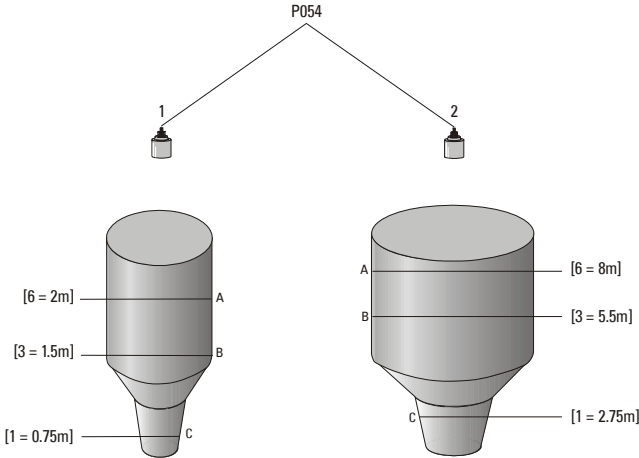

- P054 [1,1] = .75m sets breakpoint 1 on transducer 1 to .75m.
- P054 [2,1] = 8m sets breakpoint 1 on transducer 2 to 2.75m.

## Starting Measurement

The MultiRanger startup varies between single and dual point models.

**Note:** The number of points is an order option and is set by the factory. On a single point model, the index for P001 is global (G). On a dual point model the index for P001 is 1 or 2. To check the model in use, enter P001 on handheld programmer. For a single point device, parameter P001 will not show an entry for index number on the LCD. (See *MultiRanger Display* on page 36 for location of index number on the LCD.) Parameter P001 will display an index number for a dual point model.

## Single Point Models

The MultiRanger starts in DISTANCE mode with the transducer preset for the XPS-10 and an empty distance of 5 meters. Change the following parameters to reflect your application parameters.

Parameter	Index	Value	Description
P001	G	1	Operation = level
P002	G	1	Material = liquid
P003	G	2	Maximum Process Speed = medium
P004	G	104	Transducer = XPS-15
P005	G	1	Units = meters
P006	G	12	Empty = 12m
P007	G	10	Span = 10m



## Average or Differential [MR 200 only]

For differential or average operation with a single-point MultiRanger, set P001 to **4** (differential) or **5** (average) and connect two transducers of the same type. All of the relevant parameters then become indexed by the correct transducer:

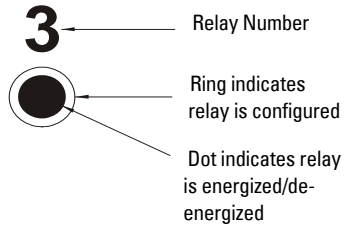

Index	Description
2	indexed by Transducer One or Two
3	indexed by level measurement 1 = Transducer One 2 = Transducer Two 3 = Calculated Level (average or difference)

## Dual Point Models

The MultiRanger starts in an OFF state and does not take level measurements. For measurement setup, configure these basic parameters:

If the application uses two measurement points, provide the basic information for each measurement point separately:

Parameter	Index	Value	Description
P001	1	1	Operation = level
	2	3	Operation = distance
P002	1	1	Material = Liquid
	2	1	
P003	1	2	Max. Process Speed = medium
	2	3	Max. Process Speed = fast
P004	1	104	Transducer = XPS - 15
	2	102	Transducer = XPS - 10
P005	G	1	Units = meters
P006	1	12	Empty = 12m
	2	4	Empty = 4m
P007	1	11	Span = 11m
	2	3.5	Span = 3.5m

## Average or Differential [MR 200 only]

For differential or average operation dual-point MultiRanger, set P001 to **4** (differential) or **5** (average) and connect two transducers of the same type.

All the relevant parameters are then indexed by the correct number:

Index	Description
2	indexed by Transducer One or Two
3	indexed by level measurement
	1 = Transducer One
	2 = Transducer Two
	3 = Calculated Level (average or difference)

## Measurement Conditions

The following information will help you configure your MultiRanger for optimal performance and reliability.

### Response Rate

The response rate of the device influences the measurement reliability. Use the slowest rate possible with the application requirements.

The response rate is also important to functions connected to the filling or emptying indicators.

### Dimensions [MR 200 only]

The dimensions of the vessel, wet well, or reservoir (except empty and span) are only important if you require volume.

Volume is required to report the level value in terms of volume. The pumped volume function can also report pumped volume or pump efficiencies.

### Failsafe

The failsafe parameters ensure that the devices controlled by the MultiRanger default to an appropriate state when a valid level reading is not available.

- P070 – Failsafe Timer activates if an error condition is detected. Upon expiration of the timer, relay status defaults to values based on P071.
- P071 – Failsafe Material Level determines the level reading if the Failsafe Timer expires and the unit is still in an error condition.
- P129 – Relay Failsafe controls the reaction of each relay. See *Relay Failsafe* on page 45 for more information.

If Failsafe Operation activates frequently, see the *Troubleshooting Appendix* on page 231.

# Relays

Relays are the primary controls of external devices such as pumps or alarms.

The MultiRanger comes with extensive control and alarm functions.

## General Introduction

Depending on the model, up to six onboard multi-purpose relays are provided on the MultiRanger. Each relay may be independently assigned to one function and has a corresponding status icon on the LCD.

The relay functions fall under three modes of operation:

Mode	Function
alarm	alarm ON = LCD Icon ON = relay coil de-energized
pump	pump ON = LCD Icon ON = relay coil energized
miscellaneous	contact closed = LCD Icon ON = relay coil energized

## Relay Function

**Note:** The MultiRanger 100 or 200 can be programmed with relays. The number of relays installed depends on the model. To determine the number of available relays that can be utilized in your MultiRanger 100 or 200, open the lid and count the large white relays to the left of the display. It is important to count the number of on-board relays as the software will allow programming of up to six relays whether they are installed or not.

## Alarm

### Level

In high alarm, the function goes on when the level rises to the ON setpoint and goes off when the level lowers to the OFF setpoint. In low alarm, the function goes on when the level lowers to the ON setpoint and goes off when the level rises to the OFF setpoint.

### In Bounds [MR 200]

The relay will be in alarm if the level is inside the zone between the setpoints.

### Out of Bounds [MR 200]

The relay will be in alarm if the level is outside the zone between the setpoints.

### Rate of Change [MR 200]

In filling alarm, the function goes on when the rate of filling increases to the ON setpoint and goes off when the rate of filling drops to the OFF setpoint. In emptying alarm, the function goes on when the rate of emptying increases to the ON setpoint and goes OFF when the rate of emptying drops to the OFF setpoint. For emptying alarm, the setpoints must be entered as negative values.

## Temperature [MR 200]

In high alarm, the function goes on when the temperature rises to the ON setpoint and goes off when the temperature lowers to the OFF setpoint. In low alarm, the function goes on when the temperature lowers to the ON setpoint and goes off when the temperature rises to the OFF setpoint.

## Loss of Echo

The function goes on when the fail-safe timer expires. The function goes OFF when a valid echo is received (fail-safe timer is reset).

## Pump

### Level

In pump down, the function goes on when the level rises to the ON setpoint and goes off when the level lowers to the OFF setpoint. In pump up, the function goes on when the level lowers to the ON setpoint and goes off when the level rises to the OFF setpoint.

## Miscellaneous

### Totalizer and Samplers [MR 200]

Refer to *Totalizing Pumped Volume* on page 65. Relays are normally de-energized, contact closure is approximately 200 mSec duration.

### Setpoint - ON / OFF

If the ON setpoint is higher than the OFF setpoint, the relay operates as:

- high alarm
- pump down control

If the ON setpoint is lower than the OFF setpoint, the relay operates as:

- low alarm
- pump up control

The ON and OFF setpoints can not be the same on an individual relay but may be common to other relays. The dead band or hysteresis is the difference between the ON and OFF setpoints. For in and out of bounds level alarms, the hysteresis is set at  $\pm 2\%$  of span from either boundary.

## Relay Status – Non Run Modes

When the fail-safe timer expires, pump control relays respond as previously described. However, alarm relays will respond in the following manner:

Fail-Safe Mode	Relay Status	
	High Alarm	Low Alarm
Fail-Safe High	ON	OFF
Fail-Safe Low	OFF	ON
Fail- Safe Hold	HOLD	HOLD

Upon entering the program mode, all pump control relays will be turned OFF. Alarm relays will hold their prior status.

### Cautions:

- If the relay status can affect plant operation or personnel safety, it is advisable to override the relay functions or disconnect the relay wiring during calibration or simulation.
- Keep power disconnected at main breaker when MultiRanger cover is opened.

## Relay States

The relays on the MultiRanger are completely programmable, allowing for any control scheme.

Relay Types
Relay 1,2,4,5 – NO (Form A)
Relay 3,6 – NO / NC (Form C)

## Relay Related Parameters

Some parameters affect how relays react during normal conditions:

### P100–Preset Applications [MR 200 only]

Sets the MultiRanger to a preset application. These preset applications quickly set up the MultiRanger with a minimum number of parameters.

### P111–Relay Control Function

Sets the default state differently, depending on whether the relay is programmed as an alarm or a control.

### P111–Alarm Functions

The alarm function de-energizes the relay coils. During normal operation (no alarms), the relay coils are energized.

### **P111–Control Functions**

The control function energizes the relay coils. When the instrument is at rest (no controls operating) the relay coils are de-energized.

### **P112–Relay ON Setpoint**

Sets the process point at which the relay is tripped.

### **P113–Relay OFF Setpoint**

Sets the process point at which the relay is reset.

### **P118–Relay Output Logic**

Affects relay reaction. Reverses the logic (normally-open to normally-closed or vice versa).

### **P129–Relay Failsafe**

Changes how individual relays react to a failsafe condition on the instrument.

## **Relay Wiring Test**

### **P119–Relay Logic Test**

Checks the application wiring by forcing a relay control function, such as a level alarm or pump control setpoint. Ensure all the relay programming and wiring works properly.

Please verify that **ON** and **OFF** respond correctly. Use P119 as a final test once all of the relay programming is done.

## **Relay Activation**

The flexibility of the relay functions ensures that the MultiRanger can support relay wiring for different systems and applications. Use the following as a guide to the most common parameters.

### **Relay Setpoints and Functionality**

**[MR 100]:** When a setpoint is reached, the corresponding action is taken. The setpoint can be an ON or OFF setpoint related to a process variable.

**[MR 200]:** The setpoint can be an ON or OFF setpoint related to a process variable, or a timed setpoint based on interval and duration.

**[MR 100]:** Functions affected by setpoint are configured by parameters that determine the application requirements such as timing. *P111 Pump and Control functions* (see page 134) sets the functions requirements.

**[MR 200]:** Functions affected by setpoint are configured by parameters that determine the application requirements such as timing. *P111 Pump and Control functions* (see page 134) sets the function requirements. Other function parameters:

- P132–Pump Start Delay
- P133–Pump Power Resumption Delay
- P645–Relay Duration

### **Relay Logic is Modified**

Normal operating conditions means that alarms are off and pumps are on. This can be reversed using P118–Relay Output Logic.

## **Relay Failsafe**

### **P129–Relay Failsafe**

Adjusts how individual relays react to a failsafe condition. Relays can be set to:

- OFF            Control is by P071–Failsafe Material Level
- HOlD         Keeps the relay in the current state
- dE             De-energizes the relay (default for pump controls)
- En             Energizes the relay

# Preset Applications

Preset applications set up the relay parameters to predetermined values shown below:

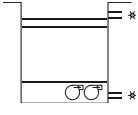
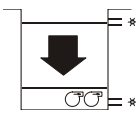
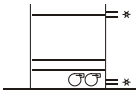
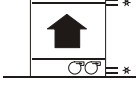
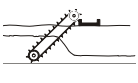
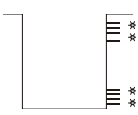
Value	#	Parameters Affected						
Off	0	All relays set to <b>OFF</b>						
Wet Well 1 	1	Pump down with the following settings:						
		Parameter	Relay #					
			1	2	3	4	5	6
		P111	52	52	1(H)	1(L)	0	0
		P112	70%	80%	90%	10%	–	–
P113	20%	20%	85%	15%	–	–		
Wet Well 2 	2	Pump down with the following level and rate settings:						
		Parameter	Relay #					
			1	2	3	4	5	6
		P111	52	52	1(H)	1(L)	0	0
		P112	70%	80%	90%	10%	–	–
		P113	20%	20%	85%	15%	–	–
P121			1					
P121 sets the pump relays to accept control by rate of level change once the first ON setpoint is reached. Because the pumps are started by rate, you must change P703 to desired empty rate.								
Reservoir 1 	3	Pump up with the following level settings:						
		Parameter	Relay #					
			1	2	3	4	5	6
		P111	52	52	1(H)	1(L)	0	0
		P112	30%	20%	90%	10%	–	–
P113	80%	80%	85%	15%	–	–		
Reservoir 2 	4	Pump up with the following level and rate settings:						
		Parameter	Relay #					
			1	2	3	4	5	6
		P111	52	52	1(H)	1(L)	0	0
		P112	20%	20%	90%	10%	–	–
		P113	80%	80%	85%	15%	–	–
P121			1					
P121 sets the pump relays to accept control by rate of level change once the first ON setpoint is reached. Because the pumps are started by rate you must change P702 to desired fill rate.								
Screen 	5	Differential control of a screen or rake:						
		Parameter	Relay #					
			1	2	3	4	5	6
		P110	3	1	2	3	0	0
		P111	50	1(H)	1(L)	1(H)	–	–
P112	80%	90%	10%	90%	–	–		
P113	20%	85%	15%	10%	–	–		
Alarms 	6	General alarms at four setpoints:						
		Parameter	Relay #					
			1	2	3	4	5	6
		P111	1(H)	1(L)	1(HH)	1(LL)	0	0
P112	80%	20%	90%	10%	–	–		
P113	75%	25%	85%	15%	–	–		



# Backup Level Override

Backup level override provides the option of overriding the ultrasonic input with another contacting point level device, for example, the Pointek CLS200. The ultrasonic reading is fixed at the programmed switch level until the discrete input is released and the ultrasonic device makes its decisions based on the override value.

## Backup Level Override Parameters

### P064: Reading Override Enable

Sets the discrete input as the source of a level reading override.

### P065: Reading Override Value

Substitutes value for current reading when the discrete input (P064) is enabled. Value is added in current units and is valid only for the following:

- level
- space
- distance
- difference
- average modes of operation
- head level in OCM mode

#### Example:

A high level backup switch is connected to Digital Input Two in the same application as Transducer One at level value 4.3 m.

#### Settings

Parameter	Index	Value
P064	1	2
P064	2	0
P065	1	4.3
P065	2	–

When the level rises to 4.3 m and the switch is activated, the reading is forced to 4.3 m where it stays until the switch is de-activated.

### P066: Override Time Delay

Sets the time (in seconds) used to calm the override condition input.

# Discrete Inputs

---

## Wiring the Discrete Inputs

Normal state is standard operation, with the MultiRanger sensing the material level and controlling the pumps.

The discrete input contacts are either **normally-open** or **normally-closed** when the system state is normal.

### Example:

Normal state for a backup high level switch is **open**, and the contacts on the discrete input are wired as **normally-open**.

See *Discrete Inputs* on page 21 for complete details on wiring the discrete inputs. To override a level using a discrete input, see *Backup Level Override* on page 47.

## Programming the Discrete Input Logic

The P270 series of parameters permits control over the discrete input.

DI State	P270 Setting
Normally Open	P270 = 2
Normally Closed	P270 = 3

The current value of the discrete input is reported in P275:

P275 Setting	MultiRanger State
0	Normal State
1	Exception State

To integrate the MultiRanger with other equipment, use the mA input and outputs.

**Note:** When a mA input parameter is accessed, a mA symbol appears in the upper left corner of the LCD display.

The mA input can be used as a level measurement or can be passed on to a SCADA system.

## mA Input [MR 200]

### Level Reading Parameters

Parameter	Index	Value	Description
P004	1	250	Transducer = mA input 1
P250	1	2	Scale = 4 to 20 mA
P251	1	0	4 mA = 0% of span
P252	1	100	20 mA = 100% of span
P253	1	0	Do not damp the input signal

To pass the mA input on to a SCADA system, read the value from the appropriate communication registers. For more information, go to the *MultiRanger Communications* section on page 89.

## mA Output



The MultiRanger has two mA outputs, used to send measurements to other devices.

Configuring the mA output to send a 4 to 20 mA signal scaled from 10% to 90% of span of the second transducer:

Parameter	Index	Value	Description
P200	1	2	set to 4 to 20 range
P201	1	1	send mA proportional to level reading
P202	1	2	base mA on level point 2
P210	1	10	set 4 mA at 10% of span <sup>1</sup>
P211	1	90	set 20 mA at 90% of span <sup>2</sup>
P219	1	0	set failsafe action as 0 mA



1. If the level reading drops below 10% of span, the mA output drops below 4 mA.
2. If the level reading rises above 90% of span, the mA output rises above 20 mA.

## Calibrating 4 mA Output

1. Connect the mA receiving device to the MultiRanger.
2. Put the MultiRanger into PROGRAM mode.
3. Set P911–mA Output Value to 4.0.
4. View the mA level on the receiving device.
5. If there is a discrepancy,
  - a. Attach ammeter to MultiRanger mA output.
  - b. Access P214, Index 1 (for mA output 1) or 2 (for mA output 2). Press CLEAR and ENTER  . The ammeter should show a value near 4 mA.
  - c. Enter the exact value displayed on the ammeter into P214 (Index 1 or 2).
  - d. The ammeter should then read exactly 4.00 mA.

The unit is now calibrated for 4 mA for the receiving device.

## Calibrating 20 mA Output

1. Connect the mA receiving device to the MultiRanger.
2. Put the MultiRanger into PROGRAM mode.
3. Set P911–mA Output Value to 20.0.
4. View the mA level on the receiving device.
5. If there is a discrepancy,
  - a. Attach ammeter to MultiRanger mA output.
  - b. Access P215, Index 1 (for mA output 1) or 2 (for mA output 2). Press CLEAR and ENTER  . The ammeter should show a value near 20 mA.
  - c. Enter the exact value displayed on the ammeter into P215 (Index 1 or 2).
  - d. The ammeter should then read exactly 20.00 mA.

The unit is now calibrated for 20 mA for the receiving device.

## Verifying the mA Range

Checks that the external device can track the entire 4 to 20 mA range sent by the MultiRanger.

1. Use P920 to put the MultiRanger into Simulation mode (see page 85).
2. Run the simulation through one complete fill / empty cycle.
3. View P911–mA Output Value to verify that it tracks to the simulation.
4. View the mA value reported on the external equipment to verify that it also tracks to the simulation.

Volume is a feature of the MultiRanger 200 only. Volume is used in two situations:

1. Calculate and display volume instead of level. For programming all setpoint parameters in terms of volume units rather than level units.
2. Calculate pumped volume to accomplish the following:
  - Totalize the volume of material that is pumped out of the wet well
  - Set an alarm on pump efficiency

If you require this functionality, please contact your local Siemens Milltronics representative at [www.siemens.com/processautomation](http://www.siemens.com/processautomation).

## Readings

When using volume, readings are given in arbitrary units specified in P051.

The default is 100, which gives a reading in percent of total. Use whatever units you want here. If the value is too large for the four-digit LCD, use a larger unit.

### Example

If a wet well has a maximum capacity of 250,000 liters, use the value 250.0 for P051 and set the reading in 1000s of liters.

## Tank Shape and Dimensions

There are many common tank shapes to select from. (See P050. If possible, use one of these.) Each tank shape uses the Empty distance (P006) in its calculations of volume.

Some tank shapes also require extra dimensions to calculate the volumes. Do not estimate these values. They must be correct to ensure the accuracy of your volume calculations.

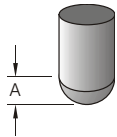

To configure volume for a tank with a half-sphere bottom, set the following:

Parameter	Index	Value	Description
P050	1	4	selects the correct tank shape
P051	1	100	sets maximum volume at 100 (percent)
P052	1	1.3	sets <b>A</b> to 1.3m

### Notes:

- The default reading changes to a range from 0 to 100 (the value in P051)
- Empty (P006) is still measured to the bottom of the tank, not the top of **A**.

# Characterization Chart [MR 200]

If you cannot use a pre-defined tank, then use one of the universal tank shapes and program the characterization curve.

1. Plot a volume to height chart. Usually a tank supplier will provide this chart. However, if you have a custom-built wet well then you will need access to complete drawings of the well or accurate measurements.
2. Enter the curve values from this chart into P054 and P055.
3. Ensure extra points are added around sharp transitions in the wet well volume (e.g: as steps in the well wall).

**Note:** The end points in the curve are 0,0 (fixed) and the point defined by P007–Span and P051–Maximum Volume.

## Example Chart

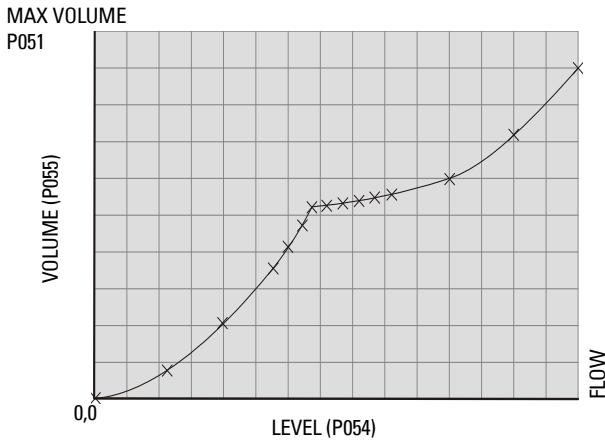

# MultiRanger 200 only

Parameter	Transducer	Index	Value	Description
P054	1	1	0.0	Determines the Level breakpoints at which the volumes are known.
		2	0.8	
		3	2.0	
		4	3.5	
		5	4.1	
		6	4.7	
		7	5.1	
		8	5.2	
		9	5.3	
		10	5.4	
		11	5.5	
		12	5.6	
		13	6.0	
		14	7.2	
		15	9.0	
P055	1	1	0.0	Determines the volumes which correspond to the level breakpoints. The universal calculations interpret between the breakpoints to produce an accurate model of the volume at all level readings.  <b>Settings</b> P050 = 9 for linear approximation P050 = 10 for curved approximation  Linear approximation uses a linear algorithm; curved approximation uses a cubic spline algorithm.
		2	2.1	
		3	4.0	
		4	5.6	
		5	5.9	
		6	6.3	
		7	6.7	
		8	7.1	
		9	7.8	
		10	8.2	
		11	8.8	
		12	9.2	
		13	10.9	
		14	13.0	
		15	15.0	

# Alarms

## Level

The level alarm is the most common. Use this alarm to warn you when your process is in danger of being upset due to high or low levels.

Generally, the four alarms used are Hi, Hi Hi, Lo, and Lo Lo.

### Set the Common Parameters

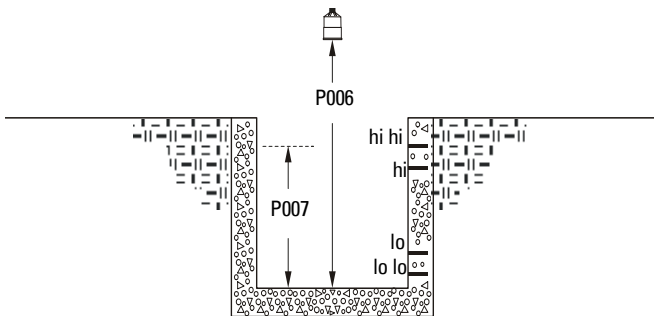

**Prerequisite:** You must know the details of your application and substitute the values for the sample values provided. If you are bench testing the unit, then set your test values to be the same as the sample values.





Parameter	Index <sup>1</sup>	Value	Description
P001	G	1	Operation = level
P002	G	1	Material = liquid
P003	G	2	Maximum Process Speed = medium
P004	G	102	Transducer = XPS-10
P005	G	1	Units = meters
P006	G	1.8	Empty = 1.8m
P007	G	1.4	Span = 1.4m

1. This example assumes a base, single measurement unit. If your unit has optional dual point software installed then some parameters are indexed by two.



# Setting Simple Level Alarms

To set Relay Five to a standard level alarm (Hi Hi, Hi, Lo, Lo Lo) do the following:

Parameter	Index	Value	Description
P110	5	1	• Set P110, indexed to relay, to the value <b>1</b> for Transducer One
P111	5	1	<ul style="list-style-type: none"> <li>• Set P111, indexed to relay, to the value <b>1</b> for level alarm</li> <li>• Press UNIT  to display the Auxiliary Function symbol.</li> <li>• Press ARROW keys   as required to scroll to the alarm designation (L, LL, H, or HH).</li> <li>• Press ENTER  to enter the value.</li> </ul>
P112	5	1.2m	• Set the <b>ON</b> setpoint
P113	5	1.15m	• Set the <b>OFF</b> setpoint

Available designations:

Alarm	Designation
Hi Hi	HH
Hi	H
Lo	L
Lo Lo	LL

## Rate [MR 200]

Rate alarms can trigger an alarm if the vessel is filling/emptying too quickly.

### Setting a Filling Rate Alarm

Parameter	Index	Value	Description
P111	5	4	These settings trip the alarm when the reservoir is filling faster than 1 m per minute and reset it at 0.9m per minute.
P112	5	1m	
P113	5	0.9m	

### Setting an Emptying Rate Alarm

Parameter	Index	Value	Description
P111	5	4	These settings trip the alarm when the reservoir is emptying faster than 10% of span per minute and reset the alarm when emptying falls to 5%.
P112	5	-10%	
P113	5	-5%	

## In Bounds/ Out of Bounds Range [MR 200]

Use the bounded range alarms to detect when the level is inside or outside of the range. By using a bounded range alarm, you can effectively put two level alarms (high and low) on one relay.

### Setting an Out of Bounds Alarm

Parameter	Index	Value
P111	5	3
P112	5	1.3
P113	5	0.3
P116	5	0.05

#### Results:

- Trips alarm above 1.35 m and below 0.25m
- Resets alarm below 1.25 m and above 0.35m

### Setting an In Bounds Alarm

Parameter	Index	Value
P111	5	2
P112	5	1.3
P113	5	0.3
P116	5	0.05

#### Results:

- Trips alarm below 1.25 m and above 0.35 m
- Resets alarm above 1.35 m and below 0.25 m

## Cable Fault

Activates an alarm if transducer cable circuit enters a shorted or opened state.

Parameter	Index	Value	Description
P111	5	7	Alarm on transducer cable fault
P110	5	1	Alarm on Transducer One

## Temperature [MR 200]

Use the temperature alarm to activate an alarm when the temperature reaches the **ON** setpoint (P112). This alarm uses the same setpoint parameters as the level alarms (P112 and P113).

With P112 and P113, you can set a high alarm (**P112 > P113**) or a low alarm (**P112 < P113**).

**This shows a high alarm:**

Parameter	Index	Value	Description
P111	5	5	Alarm on temperature
P112	5	45	<b>ON</b> setpoint at 45 °C
P113	5	43	<b>OFF</b> setpoint at 43 °C
P110	5	1	Take the temperature reading from Transducer One

The temperature source can be the temperature sensor built into the transducer or an external TS-3, as set by P660.

## Loss of Echo (LOE)

Parameter	Index	Value	Description
P110	5	1	Alarm on LOE for Transducer One
P111	5	6	Alarm on LOE
P070	G	0.5	Trip alarm when 0.5 minutes (30 seconds) pass without detecting a valid echo.

# Pump Control

## Setting a Pump Down Group

### Example: Sewage Wet Well

Setting a group of three pumps to pump down a wet well.

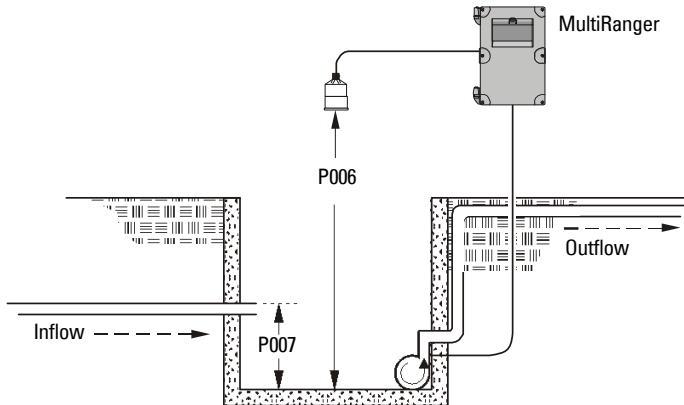

### Set the Common Parameters

**Prerequisite:** Substitute the details of your application in place of the sample values provided. If you are bench testing the unit, set your test values to be the same as the sample values.

Parameter	Index <sup>1</sup>	Value	Description
P001	G	1	Operation = level
P002	G	1	Material = liquid
P003	G	2	Maximum Process Speed = medium
P004	G	102	Transducer = XPS-10
P005	G	1	Units = meters
P006	G	1.8	Empty = 1.8m
P007	G	1.4	Span = 1.4m

<sup>1</sup>. Example assumes a single measurement unit. If your MultiRanger has dual point software installed then some parameters are indexed by two.

## Set Relays to ALTERNATE DUTY ASSIST

Parameter	Index	Value	Description
P111	1	52	Sets the pump relays (index 1, 2, and 3) to ALTERNATE DUTY ASSIST.
P111	2	52	
P111	3	52	

## Set the ON Setpoints

Parameter	Index	Value	Description
P112	1	1.0m	Sets the three setpoints for the pump relays.
P112	2	1.1m	The first cycle will use these setpoints.
P112	3	1.2m	Subsequent cycles rotate the setpoints among the pumps.

## Set the OFF Setpoints

Parameter	Index	Value	Description
P113	0	0.5m	By using index <b>0</b> all six relays are set at the same time, <b>including any alarm relays</b> . Use with caution.

## Setting a Pump Up (Reservoir) Group

Sets a group of three pumps to pump up a reservoir.

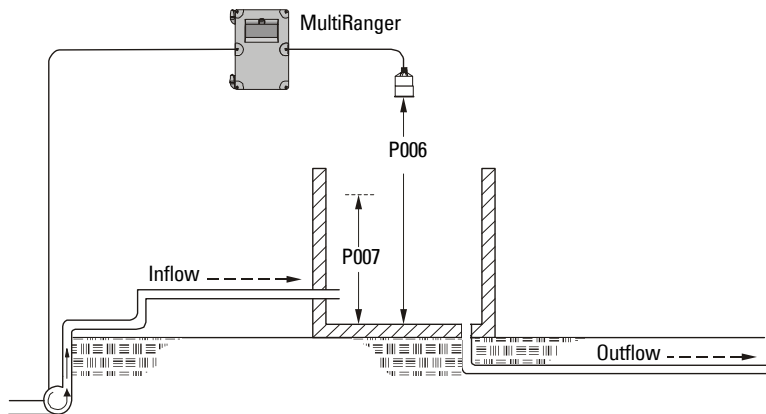

## Set the Common Parameters

**Prerequisite:** Substitute the details of your application in place of the sample values provided. If you are bench testing the unit, set your test values to be the same as the sample values.

Parameter	Index <sup>1</sup>	Value	Description
P001	G	1	Operation = level
P002	G	1	Material = liquid
P003	G	2	Maximum Process Speed = medium
P004	G	102	Transducer = XPS-10
P005	G	1	Units = meters
P006	G	1.8	Empty = 1.8m
P007	G	1.4	Span = 1.4m

- <sup>1</sup>. Example assumes a single measurement unit. If your MultiRanger has dual point software installed, some parameters are indexed by two.

## Set Relays to ALTERNATE DUTY ASSIST

Parameter	Index	Value	Description
P111	1	52	Sets the pump relays (index 1, 2, and 3) to ALTERNATE DUTY ASSIST.
P111	2	52	
P111	3	52	

## Set the Relay ON Setpoints

Parameter	Index	Value	Description
P112	1	0.4m	Sets the three setpoints for the pump relays.
P112	2	0.3m	The first cycle will use these setpoints.
P112	3	0.2m	Subsequent cycles rotate the setpoints among the pumps.

## Set the Relay OFF Setpoints

Parameter	Index	Value	Description
P113	0	1.3m	By using index <b>0</b> all six relays are set at the same time, <b>including any alarm relays</b> . Use with caution.

For more information, see *Appendix D: Pump Control Reference* on page 239.

# Other Pump Control Algorithms

## Set Relays to ALTERNATE DUTY BACKUP [MR 200]

Parameter	Index	Value	Description
P111	1	53	Sets the pump relays (index 1, 2, and 3) to ALTERNATE DUTY BACKUP.
P111	2	53	
P111	3	53	

### Set the Relay ON Setpoints [MR 200]

Parameter	Index	Value	Description
P112	1	0.4m	Sets the three setpoints for the pump relays.
P112	2	0.3m	The first cycle will use these setpoints.
P112	3	0.2m	Subsequent cycles rotate the setpoints among the pumps.

### Set the Relay OFF Setpoints [MR 200]

Parameter	Index	Value	Description
P113	0	1.3m	By using index <b>0</b> all six relays are set at the same time, <b>including any alarm relays</b> . Use with caution.

## Set Relays to FIXED DUTY ASSIST

Parameter	Index	Value	Description
P111	1	50	Sets the pump relays (index 1, 2, and 3) to FIXED DUTY ASSIST. Multiple pumps can run simultaneously.
P111	2	50	
P111	3	50	

### Set the Relay ON Setpoints

Parameter	Index	Value	Description
P112	1	0.4m	Sets the three setpoints for the pump relays.
P112	2	0.3m	The setpoints remain attached to the pump relays.
P112	3	0.2m	

### Set the Relay OFF Setpoints

Parameter	Index	Value	Description
P113	0	1.3m	By using index <b>0</b> all six relays are set at the same time, <b>including any alarm relays</b> . Use with caution.

## Set Relays to FIXED DUTY BACKUP [MR 200]

Parameter	Index	Value	Description
P111	1	51	Sets the pump relays (index 1, 2, and 3) to FIXED DUTY BACKUP. Only one pump will ever run at one time.
P111	2	51	
P111	3	51	

### Set the Relay ON Setpoints [MR 200]

Parameter	Index	Value	Description
P112	1	0.4m	Sets the three setpoints for the pump relays. The setpoints remain attached to the pump relays.
P112	2	0.3m	
P112	3	0.2m	

### Set the Relay OFF Setpoints [MR 200]

Parameter	Index	Value	Description
P113	0	1.3m	By using index <b>0</b> all six relays are set at the same time, <b>including any alarm relays</b> . Use with caution.

## Set Relays to ALTERNATE DUTY SERVICE [MR 200]

Parameter	Index	Value	Description
P111	1	54	Sets the pump relays (index 1, 2, and 3) to SERVICE RATIO DUTY ASSIST
P111	2	54	
P111	3	54	
P122	1	25	Sets the ratio to: 25% – Pump One 50% – Pump Two 25% – Pump Three
P122	2	50	
P122	3	25	

### Set the Relay ON Setpoints [MR 200]

Parameter	Index	Value	Description
P112	1	0.4m	Sets the three setpoints for the pump relays. The first cycle will use these setpoints. Subsequent cycles rotate the setpoints among the pumps.
P112	2	0.3m	
P112	3	0.2m	

### Set the Relay OFF Setpoints [MR 200]

Parameter	Index	Value	Description
P113	0	1.3m	By using index <b>0</b> all six relays are set at the same time, <b>including any alarm relays</b> . Use with caution.



# Set Relays to FIRST IN FIRST OUT (FIFO) ASSIST [MR 200]

Parameter	Index	Value	Description
P111	1	56	Sets the pump relays (index 1, 2, and 3) to FIFO DUTY ASSIST.
P111	2	56	
P111	3	56	

## Set the Relay ON Setpoints [MR 200]

Parameter	Index	Value	Description
P112	1	0.4m	Sets the three setpoints for the pump relays. The first cycle will use these setpoints. Subsequent cycles rotate the setpoints among the pumps.
P112	2	0.3m	
P112	3	0.2m	

## Set the Relay OFF Setpoints [MR 200]

Parameter	Index	Value	Description
P113	0	1.3m	By using index <b>0</b> all six relays are set at the same time, <b>including any alarm relays</b> . Use with caution.

# Optional Pump Controls

## Starting Pumps by Rate of Level Change [MR 200]

Use this function when multiple pumps will be controlled by rate of level change rather than setpoints. Pumping costs can be reduced because only the highest ON setpoint needs to be programmed. This results in a lower difference in head to the next wet well which, in turn, results in less energy being used to pump out the well.

Parameter	Index	Value	Description
P112	1	1.35	Starting pumps by rate allows all setpoints to be set higher to save money by pumping from the highest safe level of the wet well.
P112	2	1.35	
P112	3	1.35	
P113	1	0.5m	Notice that all indexed relays for both P112 and P113 are set to the same levels.
P113	2	0.5m	
P113	3	0.5m	
P121	1	1	The pumps will start on 20 second intervals until the rate set in P703 is met.
P121	2	1	
P121	3	1	
P132	G	20.0	

When the first ON setpoint is reached, the pumps will start, one by one, until the material level rate of change is set at the same value or greater than the value in:

- P703 – Emptying Indicator (pump down applications)
- P702 – Filling Indicator (pump up applications)

Set delay between pump starts using P132 – Pump Start Delay.

### Single and Dual Point [MR 200]

- Single Point Mode: one pump by rate control available that affects all pumps.
- Dual Point Mode: a single pump by rate control can be set up for each of the three available level points. Set Operation for difference or average (P001 = 4 or 5).

#### Notes:

- Set all pump control relay ON and OFF setpoints to the same value
- If the level is within 5% of Span (P007) of the OFF setpoint, then the next pump is not started

## Rotating Pumps by Service Ratio [MR 200]

**Prerequisite:** Set pump relays to a service ratio value (P111 = 54 or 55).

Parameter	Index	Value	Description
P122	1	1	These values will start Pump Two 50% of the time and Pumps One and Three each 25% of the time.
P122	2	2	
P122	3	1	

#### Notes:

- The MultiRanger will not sacrifice other pumping strategies to ensure that the ratio is held true
- If the pump relays are set to the same value, then the ratio equals 1:1 and all pumps are used equally (preset)

When more than one pump is assigned a Pump Service Ratio value (in any time units) and a pump start is required (P112 Relay Setpoint ON), the pump with the fewest running hours (with respect to the assigned ratio values) starts.



Conversely, when a pump stop is required (113 Relay Setpoint OFF), the pump with the most running hours (as compared to the assigned ratio values) stops.

# Totalizing Pumped Volume [MR 200]

**Prerequisite:** the volume of the vessel must be known.

Parameter	Index	Value	Description
P001	G	7	Operation = pumped volume
P002	G	1	These parameters are as shown above.
P003	G	2	
P004	G	102	
P005	G	1	
P006	G	1.8	
P007	G	1.4	
P050	G	1	
P051	G	17.6	Max volume is 17.6m <sup>3</sup> or 17,600 liters.
P111	1	52	Sets relays 1, 2, and 3 as a pump group using ALTERNATE DUTY ASSIST CONTROL.
P111	2	52	
P111	3	52	
P112	1	1.0	Sets the <b>ON</b> setpoints for the pump group.
P112	2	1.2	
P112	3	1.4	
P113	0	0.2	Sets the <b>OFF</b> setpoints for the pump group.

## Set in RUN Mode

1. Press PROGRAM  for RUN mode.
2. Press TOGGLE  to display pumped volume on the totalizer.
3. Press AUXILIARY  to display current level in the auxiliary reading area.

## Setting Independent Failsafe Controls

Independent failsafe controls allow you to vary an individual relay from the global failsafe controls programmed in P070 to P072.

### Example:

The global failsafe controls are set to hold and Relay Five is set to trigger an alarm bell.

Parameter	Index	Value	Description
P071	G	HOLd	Keep level at last known value.
P129	5	dE	De-energize Relay Five, and trigger alarm.

## Setting a Pump to Run On [MR 200]

When you need to pump below the normal OFF setpoint, use P130 (Pump Run-On Interval) and P131 (Pump Run-On Duration) to control this event.

### Example:

The pump connected to Relay Three is set to pump for an extra 60 seconds every 5 hours.

Parameter	Index	Value	Description
P130	3	5	Time in hours of run-on interval.
P131	3	60	Run-on for 60 seconds.

**Note:** P130 counts when the indexed relay is tripped, not the number of pump cycles. If the indexed relay only trips once every four pump cycles then the actual interval of the run-on will be 20 pump cycles, or five cycles of Relay Three.

## Setting the Pump Start Delays [MR 200]

The pump start delay ensures that all of the pumps do not start at once to avoid power surges. There are two parameters used here: P132–Pump Start Delay and P133–Pump Power Resumption Delay. The default is 10 seconds but you can increase this if your pumps take longer to spin up.

### Example:

The delay between pumps is set to 20 seconds and the delay of the first pump is set to 30 seconds.

Parameter	Index	Value	Description
P132	G	20	Wait at least 20 seconds between pump starts.
P133	G	30	Wait for 30 seconds when power is restored.

## Reducing Wall Cling [MR 200]

Use the Wall Cling parameter to randomly alter the ON and OFF setpoints over a range. This eliminates the ridge of material that builds up at the setpoint that can give false echoes.

This setting may increase the number of days between trips to clean the wet well.

Wall cling reduction is set by P136. The relay setpoints ON and OFF are randomly varied inside a range so the material level does not stop at the same point.

### Example [MR 200]:

A range of 0.5 meters is used to vary the setpoint. The randomly-selected setpoints are always **inside** the ON and OFF setpoints.

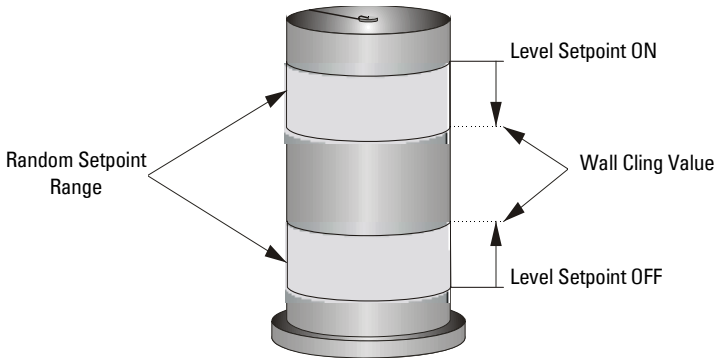

## Grouping Pumps [MR 200]

You can group pumps and use the same pumping algorithm separately on each group. If you specify different pumping algorithms then the pumps are already grouped by algorithm and you do not need to use this parameter.

Group pumps only when four pumps are using the same algorithm and you want to split them into two groups.

### Example:

Pumps One and Two can operate as a group and Pumps Three and Four can operate as another group.

Parameter	Index	Value	Description
P137	1	1	Groups Pumps One and Two
P137	2	1	
P137	3	2	Groups Pumps Three and Four
P137	4	2	

## Setting a Flush Valve [MR 200]

A flush valve stirs up the sediment on the bottom of the well during pumping so that it doesn't accumulate. These parameters will control any relays set with P111 = 64 (Flush Valve).

Most sets of parameters will work with only one or two changes; however, for these parameters to work, all of them must be set to a value.

**Example:**

The flush valve connects to Relay Four and the watched pump is on Relay One.

Parameter	Index	Value	Description
P170	G	1	Watch Relay One to count pump cycles.
P171	G	3	Open the flush valve for 3 cycles.
P172	G	10	Use the flush valve every 10 cycles.
P173	G	120	Open the flush valve for 120 seconds.

## Relay Controlled by Communications

A relay can be controlled directly by a remote system through communications. No other control schemes can then be used with a relay configured this way. Communications can be used to force status of some control relays, such as pumps.

**Settings:**

Parameter	Index	Value	Description
P111	5	65	Sets Relay Five to communications control.

## Tracking Pump Usage

You can find out how much an individual pump has been used by viewing the pump records parameters.

Information Available	Parameter Access
Current RUN time	P309
Total pump hours	P310
Total pump starts	P311
Total pump RUN on occurrences	P312 <b>[MR 200 ONLY]</b>

# Rake (Screen) Control [MR 200]

This feature is only available on the MultiRanger 200.

Screens or rakes are mounted on the inflow channel of the wastewater treatment plant to prevent debris from clogging the equipment.

When material builds up on the screen, a level differential is created, and the water level is higher in front of the screen than behind it. When this differential reaches the programmed setpoint, the MultiRanger activates a relay to operate mechanical rakes that clean the screen and ensure a steady flow.

## Setting a Rake Control

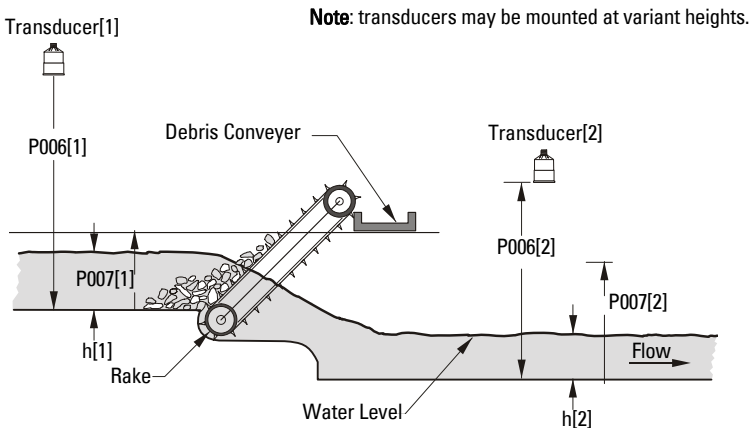
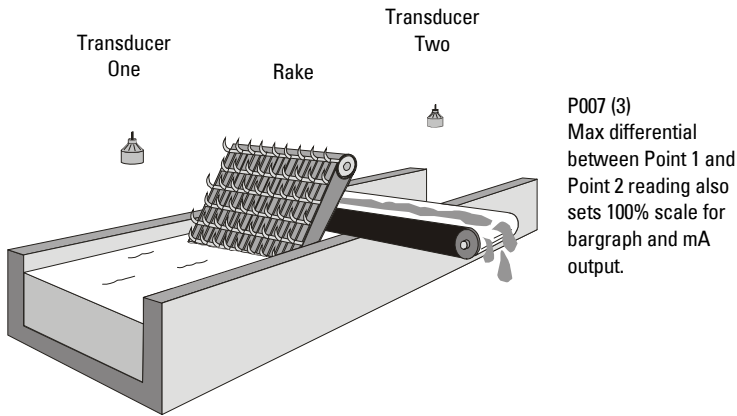

Point Three: Level Distance =  $h[1] - h[2]$

# Setting the Common Parameters

**Prerequisite:** Substitute the details of your application in place of the sample values provided. If you are bench testing the unit, set your test values to be the same as the sample values.

Parameter	Index	Value	Description	
P001	G	4	Operation	= Differential
P002	G	1	Material	= liquid
P003	1,2	2	Max. Process Speed	= medium
P004	1,2	102	Transducer	= XPS-10
P005	G	1	Units	= meters
P006	1	1.8	Empty	= 1.8m
	2	2.2	Empty	= 2.2m
P007	1	1.4	Span	= 1.4m
	2	1.4	Span	= 1.4m
	3	1.4	Max Differential	= 1.4m

## Set Relay 1 (Operate Rake)

Parameter	Index	Value	Description
P110	1	3	Starts the rake when the difference between the two levels rises above 0.4m and stop the rake when the difference falls below 0.1m.
P111	1	50	
P112	1	0.4	
P113	1	0.1	

## Set Relays 2 to 4 (Level Alarms)

P110	2	1	Description
P110	2	1	Sets Relay Two as a high level alarm for Transducer One with an ON setpoint of 1.3m and an OFF setpoint of 1.2m.
P111	2	1	
P112	2	1.3	
P113	2	1.2	
P110	3	2	Sets Relay Three as a low level alarm for Transducer Two with an ON setpoint of 0.2m and an OFF setpoint of 0.4m.
P111	3	1	
P112	3	0.2	
P113	3	0.4	
P110	4	3	Sets Relay Four as a <b>rake failure</b> alarm as it uses the differential level point (3) with an ON setpoint of 1.0m and an OFF setpoint of 0.9m.
P111	4	1	
P112	4	1.0	
P113	4	0.9	



# External Totalizers and Flow Samplers

## [MR 200]

This feature is only available on the MultiRanger 200.

External totalizers are simple counters which count the number of relay clicks produced by the MultiRanger. This is generally used to keep track of OCM or pumped volume totals. Note that both of these values are also stored in the MultiRanger and are available through communications.

Flow samplers are devices which take a sample of liquid when triggered by a relay click. These samples are used to monitor water quality over time. Flow samplers can be driven by OCM volume or by relay click volume settings depending on the application requirements.

## Relay Contacts

Pumped volume is calculated at the end of the pump cycle. Totalized volume given through a relay set up for totalizer (P111[r]=40) will be given in bursts at this time.

Both the open and closed times for the relay contact are provided by P645 and are preset to 0.2 seconds. Partial units are added to the next pump cycle.

### Example:

Shows a relay set up to make one contact for every cubic metre (m<sup>3</sup>) of liquid.

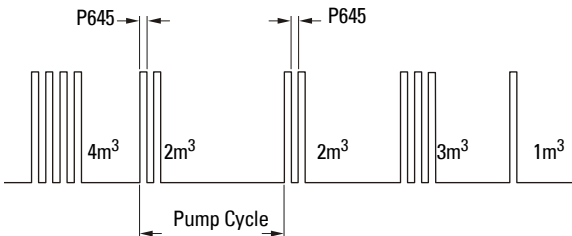

## Totalizer

To set the totalizer to provide relay contact to an external counter, use the following:

Counter Formula	
1 Contact per 10 <sup>P640</sup> units	P640 is preset to 0 so the default number of contacts for a pumped volume cycle is equivalent to the number of volume units.

**The source of units depends on the operation:**

<b>Operation</b>	<b>Units Source Parameter</b>
OCM (P001=6)	P604–Maximum Flow, or P608–Flowrate Units
Pumped Volume (P001=7)	P051–Max Volume

## Flow Sampler

### Based on Volume and Time

To trigger a flow sampler relay based on flow, use P111[r]=41 and set the other parameters:

#### Counter Formula

1 Contact per  $P641 \times 10^{P642}$  units

<b>Operation</b>	<b>Units Source Parameter</b>
OCM (P001=6)	P604 – Maximum Flow, or P608 – Flowrate Units

By using a mantissa (P641) and an exponent (P642), the relay contacts can be based on a volume other than a multiple of ten.

During the periods of low flow, the sampler may be idle for lengths of time. Program P115 to a time interval in hours to drive the sampler. The sampler will operate based on the volume of flow or the time interval, whichever comes first.

# Open Channel Monitoring (OCM)

## [MR 200]

An OCM installation is defined one of three ways, based on the Primary Measuring Device (PMD):

### 1. Dimensional (P600 = 2,3,6,7)

For some common weir and flume types. PMD dimensions (P602) are entered directly.

- BS-3680 / ISO 1438/1 Thin plate V notch weir on page 75
- BS-3680 / ISO 4359 Rectangular Flume on page 76
- Palmer Bowlus Flume on page 77
- H Flume on page 78

### 2. Exponential (P600 = 1)

For most other weir and flume types. PMD exponents provided by the manufacturer are entered. Flow is calculated using the exponent (P601) and the maximum values (P603 and P604).

- Standard Weirs on page 79
- Parshall Flume on page 80
- Leopold Lagco on page 81
- Cut Throat Flume on page 82

### 3. Universal (P600 = 4,5)

For all other PMDs, the head-to-flow curve can be plotted based on known breakpoints, usually supplied by the PMD manufacturer.

- Typical Flow Characterization on page 83
- Example Flumes on page 84
- Example Weirs on page 84

## Common Parameters

These Quick Start parameters are required for all installations.

Parameter	Index	Value	Description
P001	G	6	Operation = OCM
P002	G	1	Material = liquid
P003	G	2	Max. Process Speed = medium
P004	G	102	Transducer = XPS-10
P005	G	1	Units = meters
P006	G	1.8	Empty = 1.8m
P007	G	1.0	Span = 1.4m
P801	G	0.8	Range Extension to avoid LOE

# Setting Zero Head

Many PMDs start flowing higher than the traditional empty distance of the application. You can account for the flow in one of two ways:

1. Use P605 (Zero Head) to have OCM calculations ignore levels below that value.  
Possible head = P007 minus P605.

**Note:** P603 (Max. Head) is preset to P007 and is not updated when P605 is used. Make sure you set P603 to the correct value when using P605.

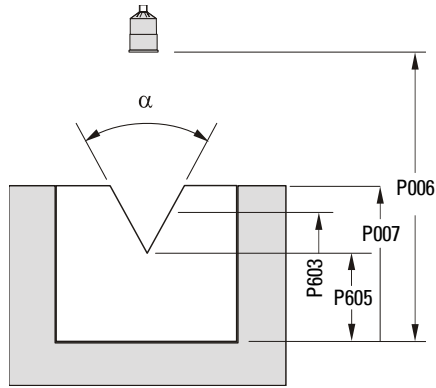

2. Use P801 Range Extension where the Empty level is set to the bottom of the weir, and above the bottom of the channel. It should be used if the surface monitored can fall past the Empty (P006) level in normal operation without reporting an LOE. The value is added to Empty (P006) and can be greater than the range of the transducer.

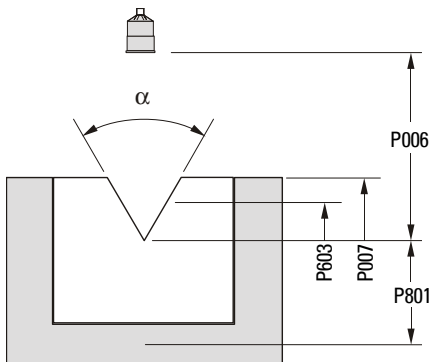

The examples on the following pages show both methods.

# Setting Totalized Volume

To display the totalized volume on the LCD use the following parameters:

Parameter	Index	Value	Description
P737	G	2	Show the eight digit totalizer in the primary display

## Applications Supported by MultiRanger 200

### BS-3680 / ISO 1438/1 Thin plate V notch weir

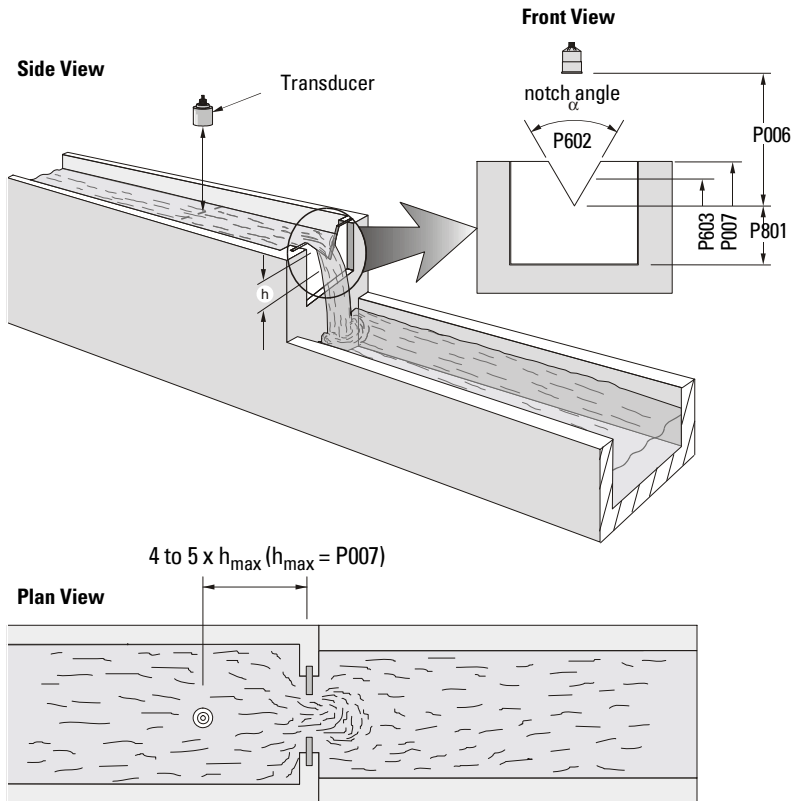

Parameter	Index	Value
P600	G	7-ISO 1438/1 V Notch Weir
P602	1	Notch angle
(view only)	2	Discharge coefficient ( $C_e$ )
P603	G	Maximum Head (preset to P007)
P801	G	Range Extension
P608	G	Flowrate Units

# BS-3680 / ISO 4359 Rectangular Flume

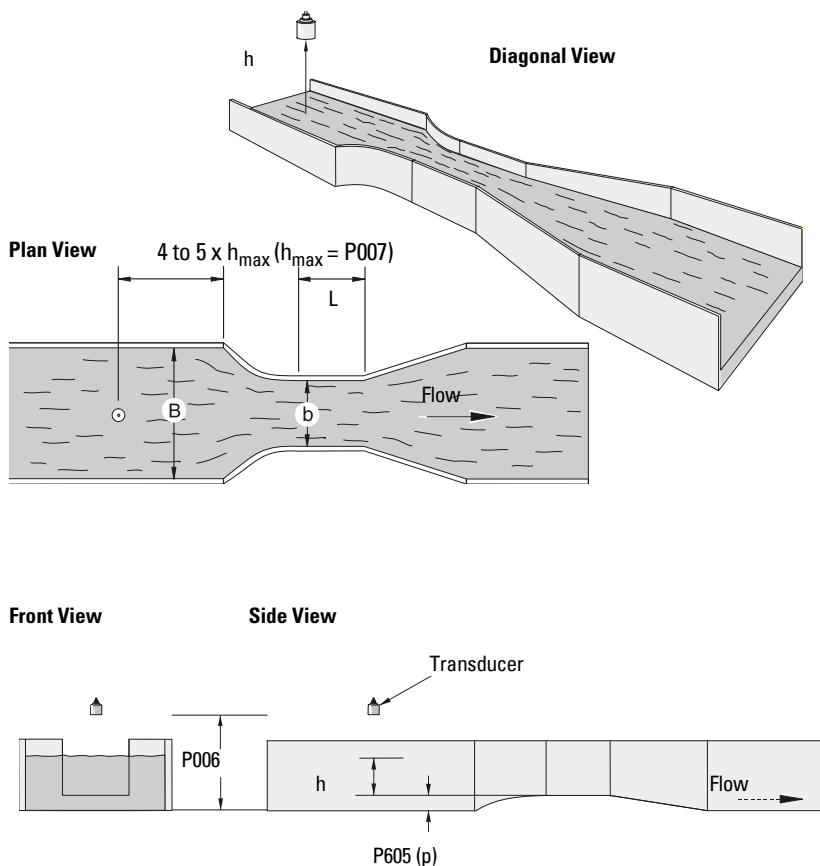

Parameter	Index	Value
P600	G	6-ISO 4359 Rectangular Flume
P602	1	Approach width (B)
	2	Throat width (b)
	3	Hump Height (p)
	4	Throat length (L)
(view only)	5	Velocity coefficient (Cv)
(view only)	6	Discharge coefficient (Cd)
(view only)	7	Cross sectional area
P605	G	Zero Head
P608	G	Flowrate Units

# Palmer Bowlus Flume

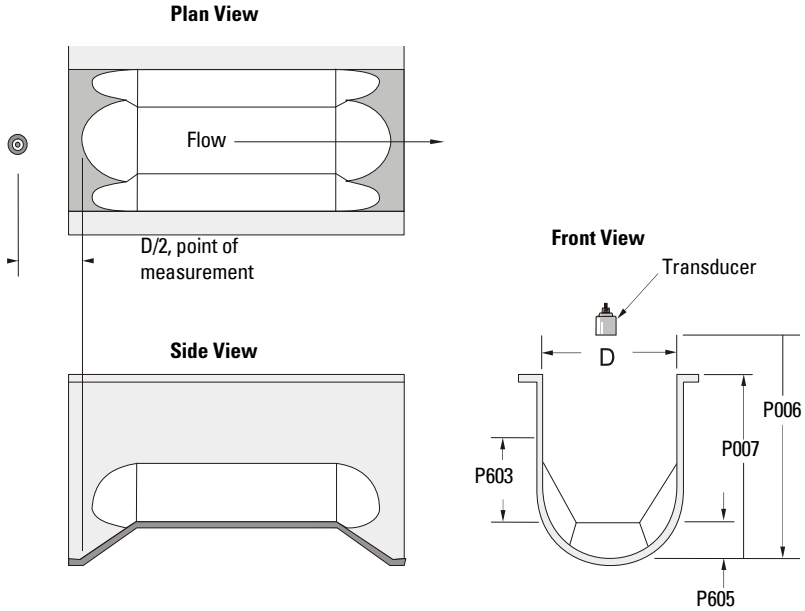

Parameter	Index	Value
P600	G	2-Palmer Bowlus Flume
P602	1	Flume width (D)
P603	G	Maximum Head (preset = P007)
P604	G	Maximum Flow
P605	G	Zero Head
P606	G	Time Units

## Application Information

- Sized by pipe diameter D
- Flume relief is trapezoidal
- Designed to install directly into pipelines and manholes
- Head is referenced to bottom of the throat, not bottom of the pipe
- For rated flows under free flow conditions, the head is measured at a distance of D/2 upstream from the beginning of the converging section

# H Flume

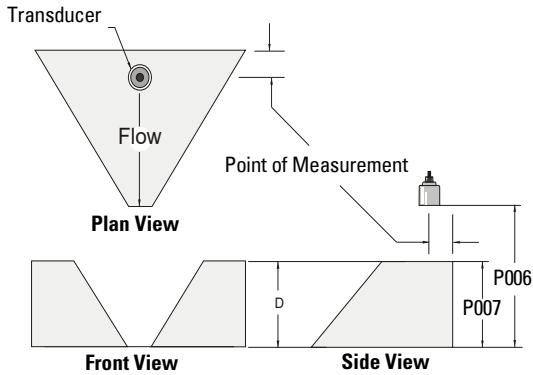

Parameter	Index	Value
P600	G	3-H Flume
P602	1	Flume height (D)
P603	G	Maximum Head (preset = P007)
P604	G	Maximum Flow
P606	G	Time Units

- Sized by maximum depth of flume
- Approach is preferably rectangular, matching width and depth for distance 3 to 5 times the depth of the flume
- May be installed in channels under partial submergence (ratio of downstream level to head). Typical errors are:
  - 1% @ 30% submergence
  - 3% @ 50% submergence
- For rated flows under free flow conditions, the head is measured at a point downstream from the flume entrance

Flume Size (Diameter in feet)	Point of Measurement	
	cm	inches
0.5	5	1¾
0.75	7	2¾
1.0	9	3¾
1.5	14	5½
2.0	18	7¼
2.5	23	9
3.0	28	10¾
4.5	41	16¼

- H flumes come with a flat or sloping floor. The same flow table can be used because error is less than 1%.



# PMDs with Exponential Flow to Head Function

For Primary Measuring Devices (PMDs) that measure flow by an exponential equation, use these parameters. Ensure that you use the correct exponent for your PMD; the values below are samples only.

## Standard Weirs

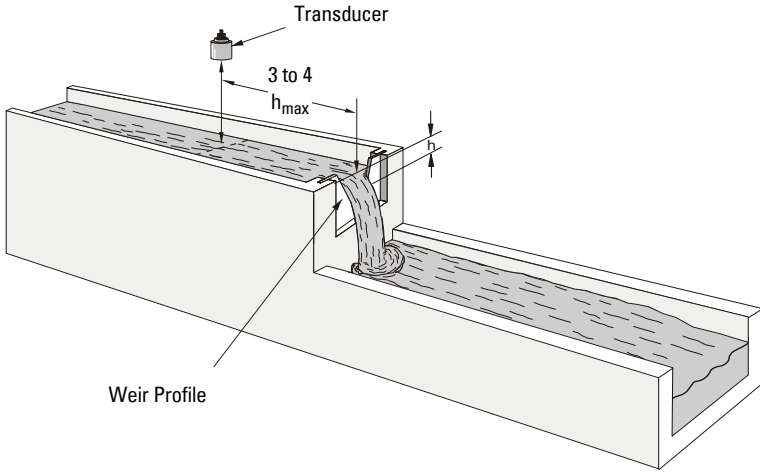

## Applicable Weir Profiles

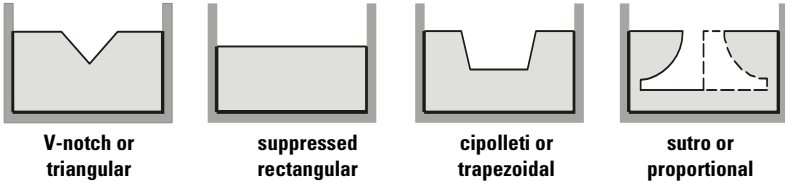

Parameter	Index	Value	
P600	G	1 - Exponential Function	
P601	G	<b>Weir Type</b>	<b>Value<sup>1</sup></b>
		V-notch	2.50
		Suppressed rectangular	1.50
		Cippolletti or trapezoidal	1.50
		Sutro or proportional	1.00
P603	G	Maximum Head	
P604	G	Maximum Flow	
P606	G	Time Units	
P801	G	Range Extension	

1. Values are samples only. Consult weir manufacturer's documentation for correct flow exponent.

## Non-Applicable Weir Profiles

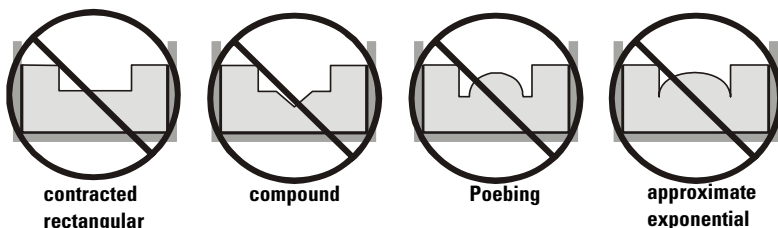

Flows through these weirs can be measured using the Universal Flow Calculation P600 = 4 or 5. See *Universal Calculation Support* on page 83.

## Parshall Flume

**Note:** C = Converging Dimension.

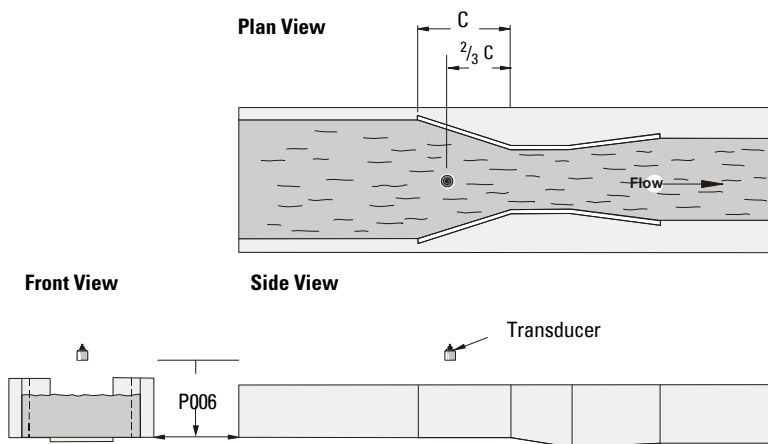

### Application Information

- Sized by throat width
- Set on solid foundation
- For rated flows under free flow conditions, the head is measured at  $\frac{2}{3}$  the length of the converging section from the beginning of the throat section

Parameter	Index	Value
P600	G	1-Parshall Flume
P601	G	1.22-1.607 (consult your flume documentation)
P603	G	Maximum Head
P604	G	Maximum Flow (Q)
P606	G	Time Units

# Leopold Lagco Flume

Plan View

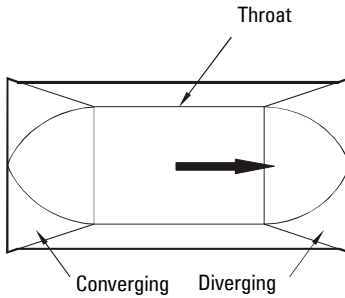

Side View

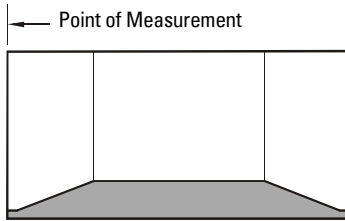

Front View

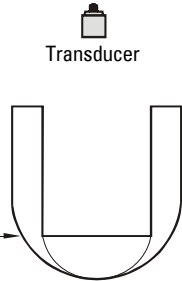

Parameter	Index	Value
P600	G	1–Leopold Lagco Flume
P601	G	1.55
P603	G	Maximum Head (preset P007)
P604	G	Maximum Flow
P605	G	Zero Head
P606	G	Time Units

## Application Information

- Designed to be installed directly into pipelines and manholes
- Leopold Lagco may be classed as a rectangular Palmer-Bowlus flume
- Sized by pipe (sewer) diameter
- For rated flows under free flow conditions, the head is measured at a point upstream referenced to the beginning of the converging section. Refer to the following table:

Flume Size (pipe diameter in inches)	Point of Measurement	
	cm	inches
4-12	2.5	1
15	3.2	1¼
18	4.4	1¾
21	5.1	2
24	6.4	2½
30	7.6	3
42	8.9	3½
48	10.2	4
54	11.4	4½
60	12.7	5
66	14.0	5½
72	15.2	6

## Cut Throat Flume

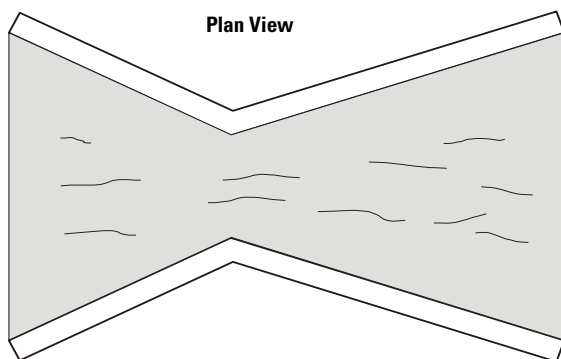

### Application Information

- Similar to Parshall flume except that the floor is flat bottomed and throat has no virtual length.
- Refer to manufacturer's specifications for flow equation and point of head measurement.

Parameter	Index	Value
P600	G	1–Cut Throat Flume
P601	G	1.55
P603	G	Maximum Head (preset P007)
P604	G	Maximum Flow
P606	G	Time Units

# Universal Calculation Support

When the primary measuring device (PMD) doesn't fit one of the standard types, it can be programmed using a universal characterization. When Universal is selected as the PMD type (P600), then both P610 and P611 must be entered to define the flow.

Two curve types are supported:

- P600 = 4-linear (piece wise linear)
- P600 = 5-curved (cubic spline)

Both are shown in the following chart.

## Typical Flow Characterization

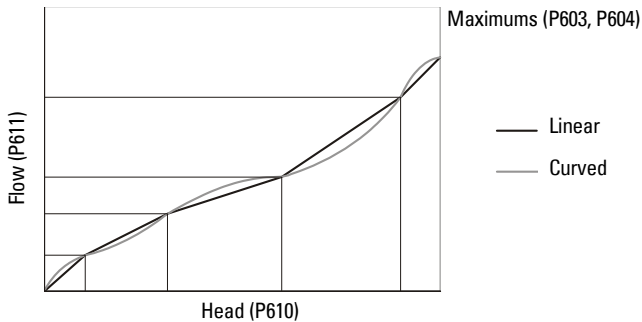

Characterization is achieved by entering the head (P610) and corresponding flow (P611), either from empirical measurement or from the manufacturer's specification. Increasing the number of defined breakpoints will increase the accuracy of the flow measurement.

Breakpoints should be concentrated in areas exhibiting the higher degrees of non linear flow. A maximum of 32 breakpoints can be defined. The curve's end point is always specified by the parameters Maximum Head (P603) and Maximum Flow (P604) for a maximum total of 33 breakpoints.

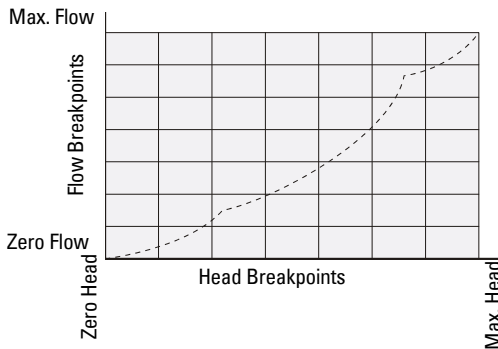

Use as many breakpoints as required by the complexity of your PMD.

See *Volume* on page 51 for more information and parameters P610 and P611 for characterization.

## Example Flumes

These example flumes would both require a universal calculation.

### Trapezoidal

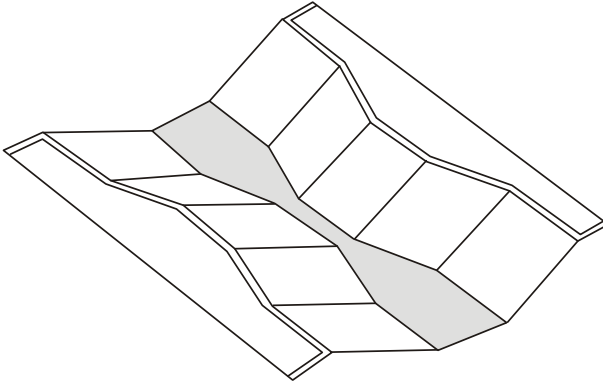

### Dual Range (nested) Parshall

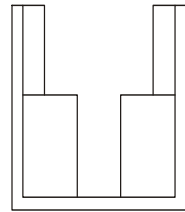
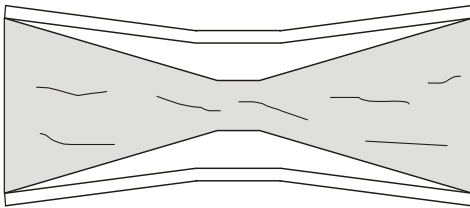

## Example Weirs

These weirs could require universal calculation.

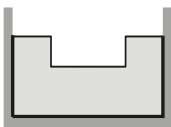

**contracted  
rectangular**

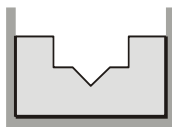

**compound**

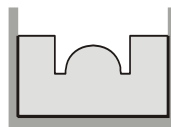

**Poebing**

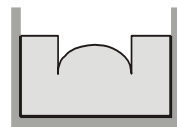

**approximate  
exponential**

# Testing the Configuration



After programming the unit, you must test the device to ensure that it performs to your specifications. This test can be run in simulation mode or by varying the level in the application. The latter is preferred as it more accurately represents running conditions. However, if it is not possible to do a physical test, a simulation will ensure that control programming is correct.

## Simulation

In simulation mode, the LCD display reacts to the simulated level changes. Alarm relays will also react to the simulation, but any pump or control relays will not react.

To allow pump or control relays to operate on the simulated level, set P000 to -1.

## Simulating a Single Measurement

Access the appropriate parameter: (press PROGRAM  and then key in the parameter number). Press TRANSDUCER  five times to overcome Echo Lock (P711) if applicable: the associated Reading is displayed in the Parameter Value field, and any **alarm** relays are set accordingly.

### To verify Reading calculations (P920 to P926)



1. Go to the parameter to be simulated (P920, P921, P922, P923, P924, P925, or P926), and key in a material level in Units (Units defined in P005), or % of Span (% of Span defined in P007).
2. Press ENTER  to display the calculated Reading. [Regardless of setting for P001, the parameter value being simulated will display as the primary reading. The auxiliary reading will always display the level value (P921). See "Display" on page 22 for positions of the primary and auxiliary readings on the LCD.]
3. Verify the calculated Reading. (At this point, the simulation is in Stop state. The effect of the ARROW key is based on this state. See chart on page 86.)

**Note:** When you set P001 = 3 (Distance), span (P007) is preset to empty (P006), therefore the primary and auxiliary readings may display the same value when Space (P922) is being simulated.



## Simulating a Level Cycle

### Starting a (P920, P921, P922, or P923) simulation when level = 0:

1. Go to the parameter to be simulated (P920, P921, P922, or P923).
2. Press ENTER  to simulate level rise and fall. At the start of a simulation, the default rate is 1% of Span / second.

- Press the ARROW  or  to adjust the simulated rate of rise or fall, based on the chart on page 86. The maximum rate is 4% of Span / second.

The effect of the ARROW key is determined by the state (rate of rise or fall) immediately before the key is pressed.

Action	State (prior to pressing key)	Effect
Press 	Stop	Rise at 1% of Span / second
	Rise at 1% of Span / second	Rise at 4% of Span / second (max.)
	Rise at 4% of Span / second (max.)	No effect
	Fall at 1% of Span / second	Stop
	Fall at 4% of Span / second	Fall at 1% of Span / second
Press 	Stop	Fall at 1% of Span / second
	Rise at 1% of Span / second	Stop
	Rise at 4% of Span / second (max.)	Rise at 1% of Span / second
	Fall at 1% of Span / second	Fall at 4% of Span / second (max.)
	Fall at 4% of Span / second (max.)	No effect

When the level rises to 100% or falls to 0%, it reverses direction at the same rate.

## Checking Volume Characterization [MR 200]

**To confirm universal volume calculations (P050 = 9, 10) are correct:**

- Go to P920.
- Key in a level associated with a known volume.
- Press ENTER .
- Check the returned volume against the manufacturer's chart.
- Change parameters P054 and P055, as required.
- Repeat steps 2 to 5 until the volume curve is verified.

## Checking OCM Flow Characterization [MR 200]

**To confirm universal flow calculations (P600 = 4, 5) are accurate:**

- Go to P925.
- Enter a level with a known flow.
- Press ENTER .
- Check the returned flow against the manufacturer's chart.



5. Change parameters P610 and P611, as required.
6. Repeat steps 2 to 5 until the flow curve is verified.

## I/O Checkout

After the unit is installed, test to verify the wiring.

### Relays

Use P119 to force a state change and verify that the results are as expected (pump starts, alarm sounds, etc.).

### Discrete Inputs

Use P270 to force the input value and verify that the results are as expected.

1. Go to P270 [DI] where DI = the discrete input to be tested
2. Set P270 to **0 (forced OFF)**
3. Go to P275 [DI] to verify that the value is forced
4. Check the state of outputs to ensure that they respond as expected
5. Go to P270 [DI]
6. Set P270 to **1 (forced ON)**
7. Go to P275 [DI] to verify that the value is forced
8. Check the state of outputs to ensure that they respond as expected

For further information see *Discrete Inputs* section on page 48.

### mA Input [MR 200]

Use P254 to test the mA input value against a true level. Use a trusted external mA source to generate the signal required for testing, and verify the incoming signal with P260. Check that the system responds as expected when the mA level is changed.

### mA Output

Use an external device to test the mA output against the measured level. Check that the mA value changes to reflect the changes in the measured level.

## Application Test

If you are testing the application by varying the material level (the preferred test method) make sure that none of the control devices is connected (or at least that no power is available to them).

If you are testing the application in simulation mode (and P000 is not -1), then control relays are not energized and the control devices can remain connected.

While the level is being cycled, check the results of the discrete inputs either by closing the circuit externally (preferred) or by using P270 Discrete Input Function to force the input ON or OFF. Try all possible combinations to thoroughly test the setup. For each combination, run a complete cycle to verify that the relays operate as expected.

Monitor system performance carefully, under all anticipated operating conditions.

1. When the MultiRanger performs exactly as required, programming is complete.
2. If alternate Reading units, Failsafe action, or relay operation is desired, update the parameters for the new functionality.
3. If the system performance experiences problems, see *General Appendix C: Troubleshooting*, on page 231.

If you cannot observe all possible operating conditions during the System Performance Evaluation, use the level simulation (see page 85) to verify programming.

When a simulation is run, alarm relays will react to the simulated level changes, but control relays will not react. You can set P000 to value -1 to trigger the control relays based on the simulated level.

Retest the system every time you adjust any control parameters.

# MultiRanger Communications

## MultiRanger Communication Systems

The MultiRanger is an integrated level controller capable of communicating process information to a Supervisory Control and Data Acquisition (SCADA) system, via a serial device such as a radio modem, leased line, or dial-up modem.

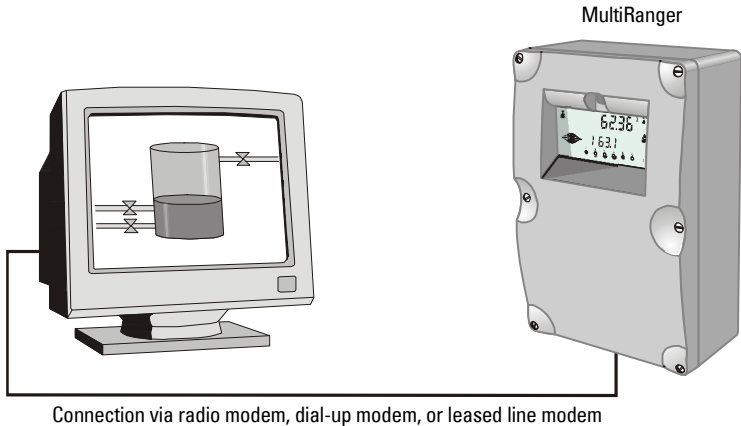

The standard MultiRanger supports the following two communication protocols:

### Modbus

Modbus is an industry standard protocol used by SCADA and HMI systems. The MultiRanger uses Modbus to communicate via the RS-485 port. For a description of the Modbus protocol, contact your local Schneider representative.

### Dolphin

Dolphin is a proprietary Siemens Milltronics protocol designed to be used with Dolphin Plus. For more information on Dolphin Plus or to obtain a copy of the software, please go to [www.siemens.com/processautomation](http://www.siemens.com/processautomation) to contact your Siemens Milltronics representative.

## Optional SmartLinx<sup>®</sup> Cards

The standard MultiRanger unit may also be enhanced with Siemens Milltronics SmartLinx<sup>®</sup> communication modules that provide an interface to popular industrial communication systems.

This manual only describes the built-in communications. For more information on SmartLinx, please consult the appropriate SmartLinx manual.

# Communication Systems

The MultiRanger is capable of communicating with most SCADA systems, PLCs, and PCs. The supported protocols are:

- Modbus RTU/ASCII – base unit on RS-232 or RS-485 transport
- PROFIBUS DP – optional SmartLinx<sup>®</sup> module
- Allen-Bradley<sup>®</sup> <sup>1</sup> Remote I/O – optional SmartLinx module
- DeviceNet<sup>®</sup> – optional SmartLinx module

## Communication Ports

The MultiRanger comes with two communication ports on the base unit.

Port	Connection	Location	Interface
1	RJ-11 connector	inside enclosure on main board	RS-232
2	terminal block	terminal block	RS-485

### RS-232

The RJ-11 jack connects to a laptop computer for the following:

- initial setup
- configuration
- troubleshooting
- periodic maintenance

### RS-485

The RS-485 port on the terminal blocks connects into industrial communications wiring and has the following advantages:

- runs communications cable farther
- allows multiple slave units on the network, addressed by P771 – Network Address

To communicate with equipment requiring RS-485 capability, Siemens Milltronics offers the RS-485 External Modem Kit. For more information, go to [www.siemens.com/processautomation](http://www.siemens.com/processautomation).

## Modbus

The Modbus protocol is supported in the base unit and can be configured using the Communications parameters P770 to P782.

To set up communications with a Modbus RTU master device on port 2 using RS-485, set the following parameters:

---

<sup>1</sup>. Allen-Bradley is a registered trademark of Rockwell Automation.  
DeviceNet is a registered trademark of Open DeviceNet Vendor Association.

Parameter	Index	Value	Description
P770	2	3	Modbus RTU slave
P771	2	1	Network address, only used for RS-485
P772	2	19.2	Data rate of 19.2 kbaud
P773	2	0	No parity, common setting
P774	2	8	8 data bits, common setting
P775	2	1	1 stop bit, common setting
P778	2	0	No modem connected
P782	2	0	Index parameter values globally

## SmartLinx

Other protocols are available through optional SmartLinx communications modules. Details on how to install and program these modules are contained in the SmartLinx documentation.

## Dolphin Plus

Dolphin Plus software makes it easy to record and compare parameter sets for all the MultiRangers in your company. Dolphin Plus uses a proprietary protocol called *Dolphin* to communicate with Siemens Milltronics instruments. This protocol is set when P770 = 1.

By default the settings for port 1 (RJ-11 connection) and Dolphin Plus match. These settings are:

Parameter	Index	Value	Description
P770	1	1	Dolphin
P772	1	115.2	Data rate of 115.2 Kilo baud
P773	1	0	No parity, common setting
P774	1	8	8 data bits, common setting
P775	1	1	1 stop bit, common setting

# Communications Installation

## Wiring Guidelines

- the RJ-11 cable maximum length is 3 meters
- RS-485 maximum length is 1,200 meters (4,000 feet)
- use 24 AWG (minimum)
- use good quality communication grade (shielded twisted pairs) cable that is recommended for RS-485 for port 2 (Belden 9842)
- run the communication cable separately from power and control cables (do not tie wrap your RS-232 or RS-485 cable to the power cable or have them in the same conduit)
- use shielded cable and connect to ground at one end only
- follow proper grounding guidelines for all devices on the bus

**Note:** Improper wiring and incorrect choice of cables are two of the most common causes of communication problems.

## Ports 1 and 2

Port	Wall Mount
1	RS-232 port (RJ-11 modular telephone jack) is on the motherboard and is generally used with a laptop computer or modem.
2	Connections for the RS-485 port are on the terminal block.

## Ports 1 and 2: RS-232 RJ-11 Jack and RS-485 Locations

The RJ-11 jack and the RS-485 port are inside the enclosure of the unit.

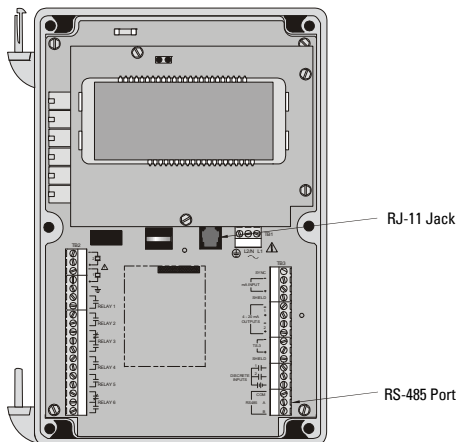

# Port 1: RS-232 RJ-11 Jack

To connect the unit to a PC using an RS-232 jack, use the cable as shown:

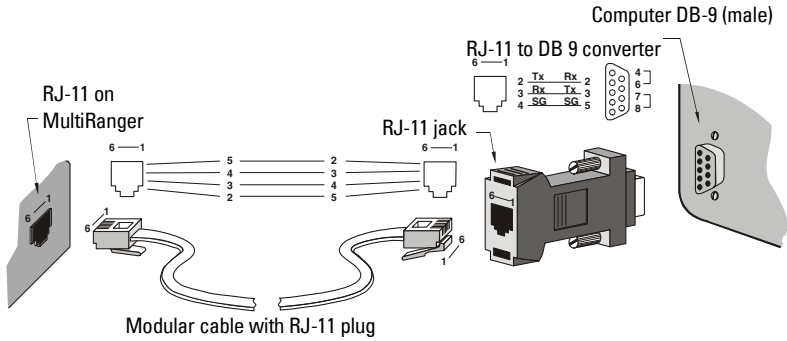

**Note:** Jumper pins 4-6 and 7-8 at the DB-9.

To connect the unit to a modem using an RS-232 jack:

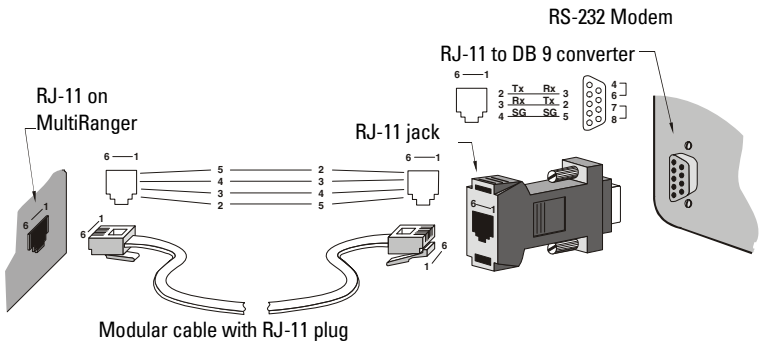

**Note:** Jumper pins 4-6 and 7-8 at the DB-9.

# Port 2: RS-485

To connect the unit to an RS-232 modem:

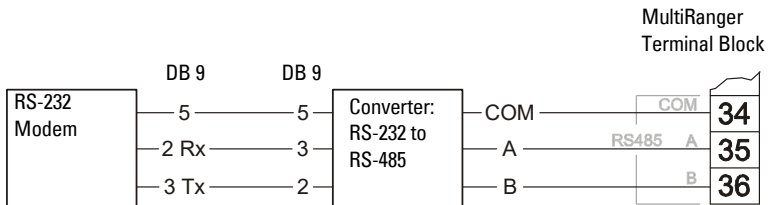

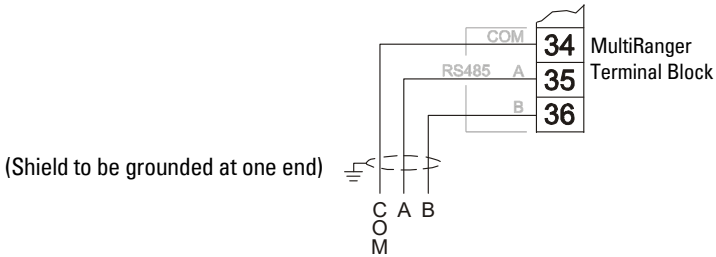

To connect the unit to a modem using an RS-485 port:

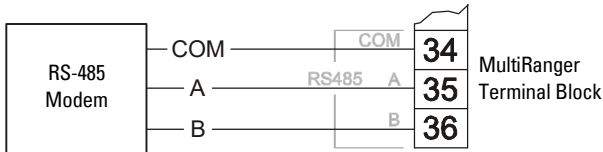

## Configuring Communication Ports (Parameters)

The 11 parameters listed are indexed to the two communication ports, unless otherwise noted: An asterisk (\*) identifies the preset value.

Port	Description
1	RS-232 port (RJ-11 modular telephone)
2	The RS-485 port is on the terminal blocks

### P770 Port Protocol

*The communications protocol used between the MultiRanger and other devices.*

Primary Index	Communications Port	
Values	0	Communications port disabled
	1	* Siemens Milltronics Dolphin protocol (preset for port 1)
	2	Modbus ASCII slave serial protocol
	3	* Modbus RTU slave serial protocol (preset for port 2)

The MultiRanger supports the Siemens Milltronics Dolphin format ([www.siemens.com/processautomation](http://www.siemens.com/processautomation)), and the internationally recognized Modbus standard in both ASCII and RTU formats. Other protocols are available with optional SmartLinx cards.

### P771 Network Address

*The unique identifier of the MultiRanger on the network.*

Primary Index	Communications Port	
Values	Range: 0 to 9999	
	1	* Preset



For devices connected with the Siemens Milltronics protocol, this parameter is ignored. For devices connected with a serial Modbus slave protocol, this parameter is a number from 1-247. The network administrator must ensure that all devices on the network have unique addresses. Do not use the value **0** for Modbus communications as this is the broadcast address and is inappropriate for a slave device.

## P772 Baud Rate

*The communication rate with the master device.*

Primary Index	Communications Port		
Values	4.8		4800 baud
	9.6		9600 baud
	19.2	*	19,200 baud (preset for port 2)
	115.2	*	115,200 baud (preset for port 1)

This specifies the rate of communication in Kbaud. Any value may be entered, but the only values supported are those shown above. The baud rate should reflect the speed of the connected hardware and protocol used.

## P773 Parity

*The serial port parity.*

Primary Index	Communications Port		
Values	0	*	No Parity
	1		Odd Parity
	2		Even Parity

Ensure that the communications parameters are identical between the MultiRanger and all connected devices, as many modems default to N-8-1.

## P774 Data Bits

*The number of data bits per character.*

Primary Index	Communications Port		
Values	Range: 5 to 8		
	8	*	Modbus RTU
	7 or 8		Modbus ASCII
	7 or 8		Dolphin Plus

## P775 Stop Bits

*The number of bits between the data bits.*

Primary Index	Communications Port		
Values	Range: 1 or 2		
	1	*	Preset

## P778 Modem Available

*Sets the MultiRanger to use an external modem.*

<b>Primary Index</b>	Communications Port		
<b>Values</b>	0	*	No modem connected
	1		Answer only

## P779 Modem Inactivity Timeout

*Sets the time that the unit will keep the modem connected with no activity.*

<b>Primary Index</b>	Communications Port		
<b>Values</b>	Range: 0-9999 seconds		
	0	*	No timeout

To use this parameter, ensure that P778 (Modem Available) =1. Ensure that the value is low enough to avoid unnecessary delays when an unexpected disconnect occurs but long enough to avoid timeout while you are still legitimately connected. This parameter value is ignored by the Modbus Master Drivers as they automatically disconnect when done communicating.

### Hangup

If the line is idle and the P779 Modem Inactivity Timeout expires, then the modem is directed to hang up the line. Ensure that P779 is set longer than the standard polling time of the connected master device. Set P779 to **0** to disable the inactivity timer.

## P782 Parameter Index Location

*Determines where index information is stored for the parameter access area for the Modbus register map.*

<b>Primary Index</b>	Global		
<b>Values</b>	0	*	Global
	1		Parameter-Specific

For more on Parameter Index Location, see *Parameter Access* on page 102.

# Modbus Register Map

Features affecting *volume*, *mA input*, and *Average or Difference* readings apply to the MultiRanger 200 only. They are clearly marked.

The memory map of the MultiRanger occupies the Modbus holding registers (R40,001 and up). This map is used when the protocol is Modbus RTU slave or Modbus ASCII slave.

## Register Map for Most Common Data

Legend	
Type	The type of data held in the group of registers.
Start	The first register to hold the referenced data.
Data Type	The possible values of the data in the register. See <i>Data Types</i> on page 107 for more information.
Description	The type of data held in the individual registers.
#R	The number of registers used for the referenced data.
Read/Write	Indicates whether the register is readable, writeable or both.

Type	Description	Start	#R <sup>1</sup>	Data Type	Read/Write
	Word Order	40,062		0/1	R/W
Map ID	Register Map Type	40,063	1	0/1 = P782	R/W
ID	Siemens Milltronics Product Code	40,064	1	4 = Model 200 6 = Model 100	R
Single Parameter Access (SPA)		R40,090	7	see <i>Appendix A</i> on page 114	
Point	Reading (3) <sup>2</sup>	41,010	2	-20,000 to 20,000	R
Data	Volume (2) <sup>3</sup> <b>[MR 200]</b>	41,020	2	-20,000 to 20,000	R

1. Maximum registers shown; fewer may be used depending on options installed.

2. Varies according to model.

**MR 100:** Available as reading 1 and reading 2 when in either Single or Dual Point Mode. In Dual Point Mode, reading 1 and reading 2 are always available.

**MR 200:** Available as reading 1, reading 2, and Average or Difference when in either Single or Dual Point Mode. In Single Point Mode, point 2 and 3 are only available if P001 = Average or Difference. In Dual Point Mode, reading 1 and reading 2 are always available. Point 3 is only available if P001[3]= Average or Difference.

3. 2<sup>nd</sup> volume available in Dual Point Mode only.

Type	Description	Start	#R <sup>1</sup>	Data Type	Read/Write
Point Data	Temperature (2)	41,030	2	-50 to 150	R
	Totalizer for points 1 and 2 [MR 200]	41,040	4	UINT32	R/W
I/O	Discrete Inputs (2)	41,070	1	Bit Mapped	R
	Relay Outputs (3 or 6)	41,080	1	Bit Mapped	R/W
	mA Input (1) [MR 200]	41,090	1	0000 to 20,000	R
	mA Output (2)	41,110	2	0000 to 20,000	R/W
Pump Control	Pump on Setpoint (3 or 6)	41,420	6	0000 to 10,000	R/W
	Pump off Setpoint (3 or 6)	41,430	6	0000 to 10,000	R/W
	Pumped Volume (2) [MR 200]	41,440	4	UINT32	R
	Pump Hours (3 or 6)	41,450	12	UINT32	R
	Pump Starts (3 or 6)	41,470	6	0000 to 10,000	R
Parameter Access		43,998 to 46999			R/W

<sup>1</sup> Maximum registers shown; fewer may be used depending on options installed.

The MultiRanger was designed to make it easy for master devices to get useful information via Modbus. This chart gives an overview of the different sections. A more detailed explanation of each section follows below.

## Word Order (R40,062)

This determines the format of unsigned, double-register integers (UINT32).

- **0** indicates that the most significant word (MSW) is given first
- **1** indicates that the least significant word (LSW) is given first

See *Unsigned Double Precision Integer (UINT32)* on page 107 for more information.

**Note:** Additional information is available from our Web site at [www.siemens.com/processautomation](http://www.siemens.com/processautomation)

## Map ID (R40,063)

This value identifies the register map used by the MultiRanger. See *P782 Parameter Index Location* on page 96.

See also *Parameter Access (R43,998 – R46,999)* on page 102 for details.

# Product ID (R40,064)

This value identifies the Siemens device type:

Device Type	Value
MultiRanger 100	6
MultiRanger 200	4

## Point Data (R41,010 – R41,031)

Measurement point data contain the current instrument readings. These are the values shown for the reading measurement for each measurement point. The reading is based on the setting for P001 (operation). P001 can be set to **level**, **distance**, **OCM flow**, or **volume**. See *Parameter Reference* section on page 117 for details.

The measurement registers are 41,010 to 41,012. The MultiRanger uses 41,010 when configured with a single transducer and 41,010 to 41,012 when configured with two transducers (P111=4 or 5 only). Two transducers can create three readings because they can generate an average or differential reading (R41,012) as well as the two level readings (R41,010 and R41,011).

### Available registers:

Data	Registers	Parameter
Reading	41,010 to 41,012	P920
Volume [MR 200]	41,020, 41,021	P924
Temperature	41,030 and 41,031	P912

The reading is expressed as a percentage of full scale, multiplied by 100:

Reading	Value
0	0.00%
5000	50.00%
7564	75.64%
20,000	200.00%

## Totalizer (R41,040 – R41,043)

The totalizers are stored as 32 bit integers using two registers. The totalizers can be read with R41,040 and R41,041 as totalizer for Point 1, and R41,042 and R41,043 as totalizer for Point 2. The totalizer values can be reset to any value by writing that value to the registers. The values can be cleared by writing zero (0) to the registers.

## Input/Output (R41,070 – R41,143)

The MultiRanger has discrete inputs, mA inputs, mA outputs and relay outputs. See below for details for each I/O type.

## Discrete Inputs (R41,070)

This table shows the current status of the discrete inputs. Only register 41,070 is used.

Discrete Input	Data Address
1	41,070, bit 1
2	41,070, bit 2

## Relay Outputs (R41,080)

This table shows the current status of the relays. A reading of **0** means that the relay function is not asserted and a **1** means that it is asserted. For example, a **1** for a pump relay means that the pump is running.

Relay	Data Address
1	41,080, bit 1
2	41,080, bit 2
3	41,080, bit 3
4	41,080, bit 4
5	41,080, bit 5
6	41,080, bit 6

Values are written to control a relay only if the Relay Control Function (P111) is set to **communications (65)**. See *Relay Function Codes (P111 Only)* on page 110.

## mA Input (R41,090) [MR 200]

The mA input is scaled from 0 to 2,000 (0 to 20 mA multiplied by 100). P254 displays the value of the input. This parameter is indexed by the input number.

## mA Output (R41,110-41,111)

The mA output is scaled from 0 to 2,000 (0 to 20 mA multiplied by 100). This is displayed in P911.

## Pump Control (R41,400 – R41,474)

Only relays set for pump control (P111 = 50 to 52) are available. These registers have no effect on relays programmed for other uses.

## Pump ON Setpoint (R41,420 – R41,425)

The **ON** setpoint level (P112) for the referenced pump relay.

The setpoint is scaled from 0 to 10,000 (0 to 100% of span multiplied by 100). So 54.02% is shown in the register as 5402.

## Pump OFF Setpoint (R41,430 – R41,435)

The **OFF** setpoint level (P113) for the referenced pump relay.

The setpoint is scaled from 0 to 10,000 (0 to 100% of span multiplied by 100). So 54.02% is shown in the register as 5402.

## Pumped Volume (R41,440 – R41,443) [MR 200]

The pumped volume registers hold the current total for all of the pumps associated with a level point. These registers are available only if operation is set to **pumped volume** (P001 = 7).

These volumes can become very large. Therefore, two registers are used to hold the value. See *Unsigned Double Precision Integer (UUINT32)* on page 107 for more information.

The value in the registers is given as an integer value but must be interpreted as having the number of decimals set in P633 (LCD Totalized Decimal Position): this number can be **0** to **3**. Ensure that your software accounts for these decimal places before you report the pumped volume totals.

## Pump Hours (R41,450 – R41,461)

The number of running hours for the referenced pump relay. The hours are given to three decimal places, so the integer must be divided by 1000 to get the correct value. For example 12,340 represents 12.34 hours.

This value comes from parameter P310. See page 157 of the *Parameter Reference* section for details.

## Pump Starts (R41,470 – R41,475)

The number of pump starts for the referenced pump relay.

This value comes from parameter P311. See page 157 of the *Parameter Reference* section for details.

# Parameter Access (R43,998 – R46,999)

Parameter values are given as integers in the range of registers from R44,000 to R44,999. The last three numbers of the register correspond to the parameter number.

Parameter Register #	Format Register #	Parameter #
44,000	46,000	P000
44,001	46,001	P001
44,002	46002	P002
...	...	...
44,999	46,999	P999

Usually, the parameters are all **read / write**.

### Note:

- Parameters P000 and P999 are **read only**. If P000 is set to **lock activated** then all of the parameters are **read only** via the handheld programmer
- Parameter P999 (Master Reset) cannot be used via Modbus
- See *Data Types* on page 107 for a description of the different types of data associated with different parameters

Each parameter register has a corresponding format register that holds the format information required to interpret the value. See *Format Words (R46,000 to R46,999)* on page 105.

## Parameter Indexing

Many parameters are indexed. There are two possible indexes: a primary index and a secondary index. A secondary index is a sub-address of the primary index. Some indexed parameters affect multiple I/O devices.

The following is an example of a primary index:

P111 is the Relay Control Function. This parameter determines how a relay is controlled by the MultiRanger (used as an alarm, for pump control, etc.). Because there are up to six relays on the MultiRanger, P111 is indexed by six to allow each relay to be programmed independently.

A few parameters also have a secondary index. While a secondary index is important for setting up the MultiRanger, it is almost never needed through remote communications.

## Indexing the Parameter Access Area

Each parameter communicates its value to only one register. You must know the index(es) for the parameter in order to interpret the information in the register correctly.

For example, to make use of the value returned in register R44,111 you must know which relay it is referring to. See *Relay Function Codes (P111 Only)* on page 110 for details on P111 values.

To determine the index values, the primary and secondary index must be **read or write**. The two possible methods of handling these index values are described in the following paragraphs: *Global Index Method* and *Parameter Specific Index Method*.



# Reading Parameters

To read parameter values, follow the steps listed in either the Global or the Parameter Specific Index Method that follow. You must be able to program your HMI or SCADA system before completing these methods.

## Global Index Method (P782 = 0)

Global format method sets index values for all parameters simultaneously. Use this method to read multiple values set to the same index values.

1. Write the primary index value into R43,999.

This is a value between **0** and **40** which specifies the input or output indexed by the parameter.

### Examples are:

- Transducer 1 is index 1
  - Discrete input 2 is index 2
  - Relay 5 is index 5
2. Write the secondary index value into R43,998.  
This is a value between **0** and **40** that specifies the secondary index on the parameter. This value is usually **0**.
  3. Write the desired format value into the appropriate format register. Because the primary and secondary indexes are already specified, these portions of the format word are ignored and only the last digit is significant.  
See *Format Registers* on page 115 for details.
  4. Read the value from the appropriate parameter register.

### Types of values are:

- *Numeric Values*, on page 107
- *Bit Values*, on page 107
- *Split Values*, on page 108
- *Text Messages*, on page 109
- *Relay Function Codes (P111 Only)*, on page 110

A value of 22,222 indicates that an error has occurred. Specify a different format type and try again.

## Parameter Specific Index Method (P782 = 1)

The Parameter Specific index method sets the index values for each parameter independently. Use this method to read multiple parameters with different index values.

1. Write the primary index, secondary index, and data format values into the appropriate format register.

For example, to read the following information:

- measured level (P921)
- in units with three decimal places

- from Transducer One

Send the integer value 01008 to register 46,921.

2. Read the value from the appropriate parameter register (the example uses 44,921).

Types of values are:

- *Numeric Values* on page 107
- *Bit Values* on page 107
- *Split Values* on page 108
- *Text Messages* on page 109
- *Relay Function Codes (P111 Only)* on page 110

A value of 22,222 indicates that an error occurred. Specify a different format type and try again.

## Writing Parameters

The method of writing parameters is similar to the method of reading them. Become familiar with *Reading Parameters*, page 103, before attempting to write any parameters.

To write parameter values to the MultiRanger, follow these steps:

### Global Index Method (P782 = 0)

1. Write the primary index value into R43,999.
2. Write the secondary index value into R43,998.
3. Write the desired format value into the appropriate format register.
4. Write the value to the appropriate parameter register.

### Parameter Specific Index Method (P782 = 1)

1. Write the primary index, secondary index, and data format values into the appropriate format register.
2. Write the value to the appropriate parameter register.

# Format Words (R46,000 to R46,999)

Format words are unsigned integers that contain up to three values (described below). The number of values used in the format words depends on the Parameter Index Location (P782) that is used.

*Parameter P782 Parameter Index Location*, described on page 96, determines which of two methods is used to access the format words: Global Index Method or Parameter Specific Index Method.

## Global Index Method (P782 = 0)

Only the final digit of the format word determines the decimal offset (below).

## Parameter-Specific Index Method (P782 = 1)

All three decimal fields are used to determine the parameter value's primary index, secondary index, and decimal offset.

## Format Registers

Each format register is made up of three decimal fields:

- decimal offset
- secondary index
- primary index

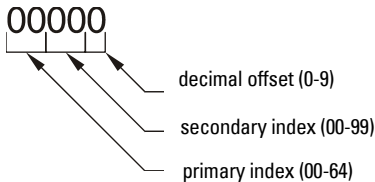

The primary and secondary indices correspond to those that are used by the parameter.

The decimal offset indicates how the remote system must interpret the integer value that is stored in the parameter access register. The following table shows how different parameter values can be shown based on a register value (integer) of **1234**.

Decimal	Offset	Example
0	0	1,234
1	-1	12,340
2	-2	123,400
3	-3	1,234,000
4	-4	12,340,000
5	-5	123,400,000
6	+1	123.4
7	+2	12.34
8	+3	1.234
9	Percent	12.34%

Examples of using the format word for both the index values and the decimal offset value are shown below:

Format	Primary Index	Secondary Index	Decimal
00000	00	00	0
01003	01	00	3 right
02038	02	03	3 left
05159	05	15	percent

To write these values you can use a decimal offset as follows: format word = (primary index x 1000) + (secondary index x 10) + (decimal).

# Data Types

The MultiRanger parameters do not always use integers to hold values. For the convenience of the programmer, those values are converted to and from a 16-bit integer number. This section describes the conversion process. The sections that follow describe where those values are in the discrete I/O and block transfer addresses, and how to get the parameters you need.

## Numeric Values

Numeric parameter values are the most common. For example, parameter P920 (Reading) returns a number that represents the current reading (either **level** or **volume**, depending on the MultiRanger configuration).

Numeric values are requested or set in units or percent of span, and may be specified with a number of decimal places.

Numeric values must be in the range  $-20,000$  to  $+20,000$  to be valid. If a parameter is requested and its value is more than  $+20,000$ , the number  $32,767$  is returned; if it is less than  $-20,000$ , the number  $-32,768$  is returned. If this overflow happens, decrease the number of decimal places.

If a parameter cannot be expressed in terms of percent of span, or has no meaningful value, the number  $22,222$  is returned. Try requesting the parameter in units, or refer to P005 in the *Parameter Reference* section on page 122.

## Bit Values

Bits are packed into registers in groups of 16 bits (1 word). In this manual, the bits are numbered from 1 to 16, with bit 1 as the least significant bit (LSB) and bit 16 as the most significant bit (MSB).

16	15	14	13	12	11	10	09	08	07	06	05	04	03	02	01
MSB															LSB

## Unsigned Double Precision Integer (UINT32)

Large numbers are put into unsigned 32 bit integers. By default, they are set up so that the first word (register) is the most significant word (MSW) and the second word (register) is the least significant word (LSW).

For example, if R41,442 is read as a UINT32, the 32 bits would look like this:

R41,442			R41,443		
16	MSW	1	16	LSW	1
32	32-bit integer value (UINT32)				1

The two registers are read as a 32-bit integer.

The most significant word (MSW) and least significant word (LSW) can be reversed to accommodate some Modbus drivers. See *Word Order (R40,062)* on page 98 for details.

The position of the decimal place is dependent on the register. For more details see the description of the register.

## Split Values

Certain parameters are actually a pair of numbers separated by a colon, using this format: **xx:yy**.

**One example is P807, Transducer Noise, where:**

**xx** = the average noise value in dB

**yy** = the peak noise in dB

The number which corresponds to **xx:yy**, either for reading or setting a parameter, is determined by the following formula:

For storing to the device:

$$\text{value} = (\mathbf{xx} + 128) \times 256 + (\mathbf{yy} + 128)$$

For reading from the device:

$$\mathbf{xx} = (\text{value} / 256) - 128$$

$$\mathbf{yy} = (\text{value} \% 256) - 128$$

where % is the modulus operator.

The modulus can be computed by following these steps:

$$\text{value}_1 = \text{value} / 256$$

$$\text{value}_2 = \text{remainder of value}_1$$

$$\text{value}_3 = \text{value}_2 \times 256$$

$$\mathbf{yy} = \text{value}_3 - 128$$

It may simplify Parameter to notice:

$$\mathbf{xx} = (\text{most significant byte of value}) - 128$$

$$\mathbf{yy} = (\text{least significant byte of value}) - 128$$

# Text Messages

If a device parameter returns a text message, that message is converted to an integer and provided in the register. The numbers are shown in the following table:

Number	Text Message as displayed on LCD
22222	Invalid value
30000	Off
30001	On
30002	≡ ≡ ≡ ≡
30003	⊠ ⊠ ⊠ ⊠ (parameter does not exist)
30004	Err
30005	Err1
30006	Open
30007	Short
30008	Pass
30009	Fail
30010	Hold
30011	Lo
30012	Hi
30013	De
30014	En
30015	---- (parameter has not been set)
-32768	Value is less than -20,000
32767	Value is greater than 20,000

## Relay Function Codes (P111 Only)

Please note that the MultiRanger 200 offers more function codes.

If a device parameter returns a relay function code, that message is converted to a number and is then provided in the register. The numbers are shown in the following table:

### MultiRanger 100

Control	Relay Function Code	Number	P111
General	OFF, relay not used	0	0
	Undesignated Level Alarm	1	1
	Low-Low Level Alarm	2	1 – LL
	Low Level Alarm	3	1 – L
	High Level Alarm	4	1 – H
	High-High Level Alarm	5	1 – HH
	Loss of Echo (LOE) Alarm	20	6
	Transducer Cable Fault Alarm	16	7
Pump	Fixed Duty Assist	25	50
	Alternate Duty Assist	30	52
Control	Communication	66	65

### MultiRanger 200

Control	Relay Function Code	Number	P111
General	OFF, relay not used	0	0
	Undesignated Level Alarm	1	1
	Low-Low Level Alarm	2	1 – LL
	Low Level Alarm	3	1 – L
	High Level Alarm	4	1 – H
	High-High Level Alarm	5	1 – HH
	In Bounds Alarm	6	2
	Out of Bounds Alarm	9	3
	Rate of Level Change Alarm	12	4
	Temperature Alarm	15	5
	Loss of Echo (LOE) Alarm	20	6
		Transducer Cable Fault Alarm	16
Pump	Totalizer	22	40
	Flow Sampler	23	41
	Fixed Duty Assist	25	50
	Fixed Duty Backup	26	51
	Alternate Duty Assist	30	52
Pump (con't)	Alternate Duty Backup	31	53
	Service Ratio Duty Assist	35	54
	Service Ratio Duty Backup	36	55
	First In First Out (FIFO)	40	56
Control	Flush Valve	65	64
	Communication	66	65

See P111 on page 134 of the *Parameter Reference* section.



# Error Handling

## Modbus Responses

When polled by a Modbus Master, a slave device will do one of the following:

1. Not reply. This means that something went wrong with the transmission of the message.
2. Echo back the command with the correct response (see the Modbus specification for more details). This is the normal response.
3. Return an Exception Code. This reflects an error in the message.

MultiRanger uses the following exception codes:

Code	Name	Meaning
01	Illegal Function	The function code received in the query is not an allowable action for the slave.
02	Illegal Data Address	The data address received in the query is not an allowable address for the slave.
03	Illegal Data Value	A value contained in the query data field is not an allowable value for the slave.

## Error Handling

Errors can be traced to two general sources:

1. There is an error in transmission.

**OR**

2. The host tries to do something that is not a valid action.

In the first case, the MultiRanger does not respond and the master waits for a **response time out** error, which causes the master to re-send the message.

In the second case, the response depends on what the host tries to do. In general, MultiRanger will not give an error to the host request. Various actions and the expected outcome are as follows:

- If the host reads an invalid register, the host will get an undetermined value back.
- If the host writes an invalid register (a non-existing parameter or a **read only** parameter), the value will be ignored and no error response will be made. However, the current value will not reflect the desired new value.
- If the host writes a **read only** register, then the value will be ignored and no error response will be made. However, the current value will not reflect the desired new value.
- If P000 is activated, then the value will be ignored and no error response will be made. However, the current value will not reflect the desired new value.

- If the host attempts to write one or more registers that are out of range, an exception response code **2** or **3** is generated, depending if the start address is valid.
- If the host used an unsupported function code, an exception response code of **01** should be generated. However, this is not guaranteed and there may be no response.

# Communication Troubleshooting

---

## Generally

1. Check the following:
  - There is power at the unit
  - The LCD is showing the relevant data
  - The device can be programmed using the hand programmer
2. Check the wiring pin outs and verify that the connection is correct.
3. Verify that values in the set-up parameters (P770 to P779) match the settings in the computer used to communicate with the unit.
4. Check that the port on the computer is correct. Sometimes trying a different Modbus driver will solve the problem. An easy stand-alone driver called ModScan32 is available from Win-Tech at [www.win-tech.com](http://www.win-tech.com). This driver is helpful for testing communications.

## Specifically

1. The MultiRanger is set to communicate via a modem but no communication is returning to the master.
  - Check that the parameters are set up correctly and that the correct port is configured
  - Verify the wiring diagram. Note that there is a difference between wiring directly to a computer and wiring to a modem.
  - Verify that the modem is set up correctly. Siemens Milltronics has a series of Application Guides that may help. Please contact your local Siemens Milltronics representative for more information on Application Guides.
2. A MultiRanger parameter is set via remote communications, but the parameter remains unchanged.
  - Some parameters can only be changed when the device is not scanning. Try putting the device in program mode, using the operating mode function.
  - Try setting the parameter from the keypad. If it can not be set using the keypad, check the lock parameter and set it to **1954**.

# Communication Appendix A: Single Parameter Access (SPA)

---

This Appendix is intended to provide someone with advanced communications knowledge the ability to access any parameter value in any available format.

Built into MultiRanger is an advanced handshaking area that can be used to read and write single registers to the MultiRanger. This section performs a similar function to the Parameter access section. The differences are:

1. Advanced section is more powerful and harder to program.
2. Advanced section only gives you access to one parameter at a time.

## Mapping

Parameter Read and Write (40,090 – 40,097) is a series of eight registers used for reading and writing parameter values to and from the MultiRanger. The first three registers are always unsigned integers representing parameters and index values. The second five registers are the format and value(s) of the parameter.

All parameters normally accessed through the hand-held programmer are available through these registers.

Address	Description
40,090	Parameter (integer)
40,091	Primary Index (integer)
40,092	Secondary Index (integer)
40,093	Format word (bit mapped)
40,094	Read value, word 1
40,095	Read value, word 2
40,096	Write value, word 1
40,097	Write value, word 2

## Reading Parameters

To read parameters through Modbus do the following steps:

1. Send the parameter, its primary index, and its secondary index (usually 0), and format to registers 40,090 to 40,093.
2. Wait until you can read the written values from the registers (40,090 to 40,093) to confirm that the operation is complete.
3. Read the value from registers 40,094 and 40,095.

# Writing Parameters

To set parameters through Modbus do the following steps:

1. Send the parameter, its primary index, and its secondary index (usually **0**) to registers 40,090, 40,091, and 40,092.
2. Write the value to registers 40,096 and 40,097.
3. Write the desired format word to register 40,093 to enable the MultiRanger to interpret the value correctly.

## Format Register

Bits	Values	Description
1-8	0-2	Error Code
9-11	0-7	3-bit number representing decimal offset
12	0/1	direction of offset (0 = right, 1 = left)
13	0/1	Numeric format: Fixed (0) or Float (1)
14	0/1	Read or Write of data, Read (0), Write (1)
15	0/1	Word order: Most Significant Word first (0), Least Significant Word first (1)
16		Reserved

For example, to format the level reading so that it is shown in percent with two decimal places shifted left, the format bits would look like this:

Bit Numbers	16	15	14	13	12	11	10	09	08	07	06	05	04	03	02	01
Bit Values	0	0	0	0	0	0	1	0	0	0	0	0	0	0	0	0
	reserved	most significant first	read	fixed format	offset direction to right	decimal offset of 2			no error code							

The value sent to the MultiRanger is 0001001000000000 binary or 512 decimal. The value **512** is sent as an integer to register 40,093 to format the output words 40,094 and 40,095 accordingly.

If the numeric data type is set for integer and the value contains decimal places, they are ignored. In this situation, use the decimal offset to ensure that you have an integer value and then write your code to recognize and handle the decimal offset.

# Error Codes

The error codes returned in the format area are 8-bit integers found in the lowest eight bits of the format word. This allows for 256 potential error codes.

Currently the MultiRanger has two error codes available.

Values	Description
0	No error
1	Data not available as percent (available as units)
2-255	Reserved

# Parameter Reference

---

The MultiRanger is configured through its parameters, and the application determines the parameter values which are entered into the unit.

Please check your value entries carefully before operating the MultiRanger to ensure optimum performance.

## MultiRanger 100 and MultiRanger 200

All MultiRanger 100 and MultiRanger 200 parameters are listed in this section. MultiRanger 200 parameters are identified separately. The parameter title includes this marking **[MR 200]**, indicating that parameter applies to the MultiRanger 200 only.

As a general rule, parameters affecting volume apply only to the MultiRanger 200.

## Helpful Hints

Please note the following:

- **Default** values are always indicated with an asterisk (\*)
- **Global** values are common for all inputs and outputs on the unit
- **Indexed** parameters can apply to more than one input or output
- **Primary index** relates to an input or output
- **Secondary index** allows for multiple values on an indexed point

### Accessing a Secondary Index

1. Press MODE  $\left[ \begin{array}{c} \blacktriangle \\ \% \end{array} \right]$  and then press DISPLAY  $\left[ \begin{array}{c} \blacktriangle \\ \blacktriangle \end{array} \right]$  to activate secondary index.  
The  $\rightarrow$  icon appears under the index field.
2. Enter the secondary index, and then enter the values to set the secondary index.

# Index types

Name	Description	# of indexes
Global	This parameter applies to the entire unit	n/a
View only	This parameter can not be set, only viewed	n/a
Breakpoint	Indexed by breakpoint	Parameter dependent
Dimension	Indexed by PMD dimension	up to 7
Discrete Input	Indexed by discrete input	2
Echo Profile	Indexed by stored echo profile	10
Level <sup>1</sup>	Indexed by level point	1, 2 or 3
mA input <sup>1</sup>	Indexed by mA input	1
mA output <sup>1</sup>	Indexed by mA output	0 or 2
Comm. Port	Indexed by communications port	2
Relay	Indexed by relay	3 or 6
Transducer <sup>2</sup>	Indexed by transducer	1 or 2

- MultiRanger 100:** The two level points are: Transducer One and Transducer Two.  
Level point typically has 1 index in Single Point Mode (standard), and 2 indexes in Dual Point Mode (optional).

**MultiRanger 200:** The three level points are: transducer 1, transducer 2, and the calculated point which can be difference (P001=4) or average (P001=5).  
Level point typically has 1 index in Single Point Mode (standard), and 2 indexes in Dual Point Mode (optional). A third index is available in both modes when Operation (P001) is set for DPD (P001=4) or DPA (P001=5).
- MultiRanger 200:** The number of indexes available in Single Point Mode (standard) is typically 1, but can be expanded to 2 if Operation (P001) is set for DPD (P001=4) or DPA (P001=5).  
In Dual Point Mode (optional), the number of available indexes is always 2.



# P000 Lock

## Notes:

- This lock only applies to the handheld programmer: it does not lock access through communications.
- A remote master can change configuration if P799 is set to allow this.

*Secures the MultiRanger from changes via the handheld programmer.*

<b>Primary Index</b>	Global		
<b>Values</b>	1954	*	OFF (programming permitted)
	-1		Simulation Controls (relays energize based on simulated level)
	other		lock activated (programming secured)
<b>Related</b>			• Simulation on page 85

## WARNING:

**Use this lock as backup security only. It uses a fixed value which can be discovered by unauthorized personnel.**

Access this parameter directly (type **000**) and enter any value (except 1954) to secure programming lock. To unlock the MultiRanger, access this parameter and enter **1954**.

## Quick Start (P001 to P007)

### P001 Operation

*Sets the type of measurement required for the application.*

Primary Index	Single Point Model		Dual Point Model
	Global		Transducer
<b>Values</b>	0		Out-of-service
	1		Level – how full the vessel is ( <b>MR 200</b> : volume – P050)
	2		Space – how empty the vessel is ( <b>MR 200</b> : ullage – P050)
	3	*	Distance – distance from transducer to material
	4		DPD – dual point difference [ <b>MR 200</b> ]
	5		DPA – dual point average [ <b>MR 200</b> ]
	6		OCM – flow rate in an open channel [ <b>MR 200</b> ]
	7		Pump Totalizer – total pumped volume [ <b>MR 200</b> ]
<b>Alters</b>	• P600 Primary Measuring Device		

## For DPD and DPA Programming [MR 200]

Please note that this feature is only available on the MultiRanger 200.

### Single Point Model Use

For Dual Point Difference (DPD) or Dual Point Average (DPA), the unit requires either two transducers of the same type, or one transducer and one mA input. If two transducers are used, all transducer parameters become indexed, and a third level point is calculated.

- DPD (difference) = Point 1 - Point 2
- DPA (average) = (Point 1 + Point 2) / 2. The calculated DPD or DPA is always based on level measurements of points 1 and 2.

For these operations any of three level points (transducer 1, transducer 2, or the calculated point) can be used to trigger relays (see *P110 Level Source* on page 134).

The points must be globally set to either 4 or 5 (as required). Point 3 becomes the calculated value as shown above. See *Rake Control* example on page 69.

### Dual Point Model Use

To set a dual point MultiRanger for DPA or DPD functions, Point 3 must be set to either 4 or 5 (as required). Points 1 and 2 cannot be set to 4 or 5, but these points are used to calculate the value in point 3.

This table shows the available functions:

Operation [index]	Available Values
P001 [1]	1, 2, 3, 6, 7
P001 [2]	1, 2, 3, 6, 7
P001 [3]	4,5

## P002 Material

*Specifies material type.*

Primary Index	Single Point Model		Dual Point Model
	Global		Transducer
Values	1	*	Liquid or horizontal solid surface
	2		Solid or angled surface
Alters	• P830 TVT Type		

# P003 Maximum Process Speed

*Determines level change reaction.*

Primary Index	Transducer	
Values	1	Slow (0.1 m/min)
	2	* Medium (1 m/min)
	3	Fast (10 m/min)
Alters	<ul style="list-style-type: none"> <li>• P070 Failsafe Timer</li> <li>• P700 Max Fill Rate</li> <li>• P701 Max Empty Rate</li> <li>• P702 Filling Indicator</li> <li>• P703 Emptying Indicator</li> <li>• P704 Rate Filter</li> <li>• P710 Fuzz Filter</li> <li>• P713 Echo Lock Window</li> <li>• P727 Scan Delay</li> <li>• P841 Long Shot Number</li> </ul>	
Related	<ul style="list-style-type: none"> <li>• Failsafe (P070 to P072)</li> <li>• P121 Pump by Rate</li> <li>• Rate (P700 to P708)</li> <li>• Measurement Verification (P710 to P713)</li> <li>• Transducer Scanning (P726 to P729)</li> <li>• P905 Transmit Pulse</li> </ul>	

Use a setting just fast enough to keep up with your process. Slower settings provide higher accuracy. Faster settings allow for more level fluctuations.

# P004 Transducer

*Specifies the Siemens Milltronics transducer connected to the unit.*

Primary Index	Single Point Model		Dual Point Model
	Global		Transducer
Values	0	*	No transducer attached (preset for Dual Point)
	1		ST-25
	2		ST-50
	100		STH
	101		XCT-8
	102	*	XPS-10 (preset for Single Point Model)
	103		XCT-12
	104		XPS-15
	112		XRS-5
	250		mA input <b>[MR 200]</b>

(chart con't next page)

<b>Related</b> (chart cont'd from previous page)	<ul style="list-style-type: none"> <li>• P203 mA Output Value/Transducer</li> <li>• mA Input (P250 to P260) (related only to Value 250)</li> <li>• P800 Near Blanking</li> <li>• P823 Reform Echo</li> <li>• P832 TVT Shaper Adjust</li> <li>• P840 Short Shot Number</li> <li>• P841 Long Shot Number</li> <li>• P842 Short Shot Frequency</li> <li>• P843 Long Shot Frequency</li> <li>• P844 Short Shot Width</li> <li>• P845 Long Shot Width</li> <li>• P852 Short Shot Range</li> </ul>
---	--

## P005 Units

*Specifies measurement units used for dimensional values.*

<b>Primary Index</b>	Global	
<b>Values</b>	1	Meters
	2	Centimeters
	3	Millimeters
	4	Feet
	5	Inches
<b>Alters</b>	<ul style="list-style-type: none"> <li>• P006 Empty</li> <li>• P007 Span</li> <li>• P603 Maximum Head</li> <li>• P605 Zero Head</li> <li>• P620 Low Flow Cutoff</li> <li>• P921 Material Measurement</li> <li>• P926 Head Measurement</li> <li>• P927 Distance Measurement</li> </ul>	

Changing this value automatically changes the units displayed for many parameters. Existing values are converted and do not have to be re-entered.

## P006 Empty

*Enter distance in **units** (P005) from the face of the transducer to the process empty point.*

<b>Primary Index</b>	Transducer
<b>Values</b>	Range: 0.000 to 99.000 m (or equivalent depending on units)
	Preset: 5.000 m (or equivalent depending on units)
<b>Alters</b>	<ul style="list-style-type: none"> <li>• P007 Span</li> </ul>
<b>Altered By</b>	<ul style="list-style-type: none"> <li>• P005 Units</li> </ul>
<b>Related</b>	<ul style="list-style-type: none"> <li>• P800 Near Blanking</li> <li>• P921 material Measurement</li> <li>• P927 Distance Measurement</li> </ul>

Setting this value also sets Span (P007) unless Span was already set to another value. For distance operation (P001=3), Span is preset to Empty.

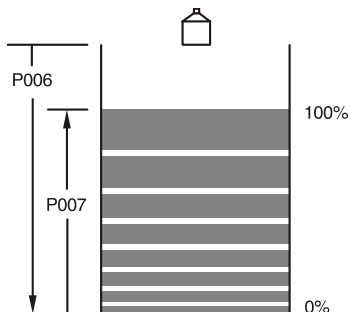

## P007 Span

*Sets the range levels to be measured.*

<b>Primary Index</b>	Level
<b>Values</b>	Range: 0.000 to 99.000 m (or equivalent depending on units)
	Preset: based on Empty (P006)
<b>Alters</b>	<ul style="list-style-type: none"> <li>• P605 Zero Head</li> <li>• P112 Relay ON Setpoint</li> <li>• P113 Relay OFF Setpoint</li> </ul>
<b>Altered By</b>	<ul style="list-style-type: none"> <li>• P005 Units</li> <li>• P006 Empty</li> </ul>
<b>Related</b>	<ul style="list-style-type: none"> <li>• Volume (P050 to P055)</li> <li>• P800 Near Blanking</li> <li>• P921 Material Measurement</li> <li>• P922 Space Measurement</li> <li>• P926 Head Measurement</li> </ul>

Span is preset for a value close to the maximum available. Enter a value reflecting maximum application range.

Always prevent the monitored surface from approaching within 0.3 m (1 ft) of the transducer face as this is the minimum blanking for most Siemens Milltronics transducers (some require more blanking – see your transducer manual).

Many other parameters are set as a percentage of span (even if they are entered in units). The values of these other parameters may change if the span is altered after installation and the other parameters are measured using a level determined upward from the Empty level toward the transducer face.

### MultiRanger 200

All volumes are based on span so it should be set for the maximum volume point if volume calculations are needed.

## Volume (P050 to P055) [MR 200]

Please note that the volume parameters apply only to the MultiRanger 200.



Use these parameters to enable the MultiRanger to show readings based on vessel or wet well volume (rather than level)..



# P050 Tank Shape [MR 200]

Enter the Tank Shape value matching the monitored vessel or wet well.

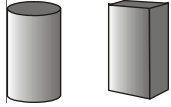
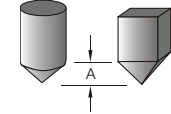
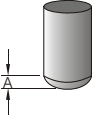
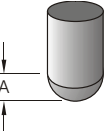
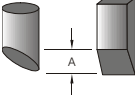
When Operation is **LEVEL** (P001 = 1), liquid (material) volume is calculated.

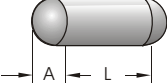
Alternatively, when Operation is **SPACE** (P001 = 2), remaining vessel capacity is calculated. In RUN mode, readings are displayed in percent of maximum volume. To convert readings to volumetric units, see *Maximum Volume (P051)*.

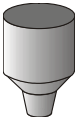
Primary Index	Level		
	#	Shape	Description
Values	0	*	volume calculation not required (preset)
	1		Flat Level Bottom
	2		Cone/Pyramid Bottom
	3		Parabola Bottom
	4		Half Sphere Bottom
	5		Flat Sloped Bottom
	6		Flat Ends
	7		Parabola Ends

<b>Values</b>	8		Sphere
	9		Universal Linear
	10		Universal Curved
<b>Alters</b>	<ul style="list-style-type: none"> <li>• P001 Operation</li> <li>• P051 Maximum Volume</li> <li>• Pump Efficiency (P180-P186)</li> <li>• Pumped Volume Totalizer (P622-P623)</li> <li>• P920 Reading Measurement</li> </ul>		

## P051 Maximum Volume [MR 200]

*For Readings in volumetric units (rather than percent), enter the equivalent vessel volume for Span (P007).*

<b>Primary Index</b>	Level
<b>Values</b>	Range: 0.000 to 99999
	Preset: 100.0
<b>Alters</b>	P060 Decimal Position
<b>Related</b>	<ul style="list-style-type: none"> <li>• P006 Empty</li> <li>• P007 Span</li> <li>• P924 Volume Measurement</li> </ul>

Any volume units can be chosen because volume is calculated from empty to maximum span and is scaled according to the Tank Shape (P050) value.

**Note:** Make sure selected chosen units allow LCD volume display.

**Examples:**

- If max. volume = 3650 m<sup>3</sup>, enter 3650
- If max. volume = 267500 gallons, enter 267.5 (thousands of gallons)

## P052 Tank Dimension A [MR 200]

*Dimension A as used in P050 Tank Shape.*

<b>Primary Index</b>	Level
<b>Values</b>	Range: 0.0 to 99.00 m (or equivalent depending on units)
	Preset: 0.000
<b>Related</b>	• P050 Tank Shape

Enter one of the following:

- height of the tank bottom if P050 = 2,3,4, or 5

OR

- length of one end section of the tank if P050 = 7, in Units (P005)

## P053 Tank Dimension L [MR 200]

*Dimension L as used in P050 Tank Shape.*

<b>Primary Index</b>	Level
<b>Values</b>	Range: 0.0 to 99.00 m (or equivalent depending on units)
	Preset: 0.000
<b>Related</b>	• P050 Tank Shape

Enter the following:

- tank length (excluding both end sections) if P050 = 7

## P054 Level Breakpoints (Universal Volume Calculation) [MR 200]

*When the tank shape is too complex for any of the preconfigured shapes, you can specify the volume based on segments. See "Accessing a Secondary Index" on page 117 for more information.*

<b>Primary Index</b>	Level
<b>Secondary Index</b>	Breakpoint
<b>Values</b>	Range: 0.0 to 99.00 m or Max. volume (P051) (or equivalent depending on units)
<b>Related</b>	• P055 Volume Breakpoints

Enter the following:

- up to 32 level breakpoints (where volume is known) if P050 = 9 or 10

### Entering a Level Breakpoint

1. Go to Parameter P054.
2. For each index enter a breakpoint in measurement units.
3. Ensure that each breakpoint corresponds to the same index for P055.



# P055 Volume Breakpoints and Characterization (Universal Volume Calculation) [MR 200]

Each segment defined by the level breakpoints (P055) requires a volume so that the MultiRanger can make the level-to-volume calculations.

<b>Primary Index</b>	Level
<b>Secondary Index</b>	Breakpoint
<b>Values</b>	Range: 0.0 to 99999
<b>Related</b>	<ul style="list-style-type: none"> <li>P054 Breakpoints Levels (Universal Volume Calculation)</li> </ul>

## Typical volume calculations

Cone

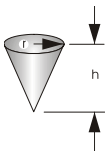

$$V = (1/3)\pi r^2 h$$

Cylinder

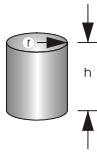

$$V = \pi r^2 h$$

## Entering a Volume Breakpoint

1. Go to Parameter P055.
2. For each index enter a volume.
3. Ensure that each volume corresponds to the same index for P054.

For more on *Volume Characterization*, go to page 52.

## Display and Reading (P060 to P062)

These parameters are used to:

- Change the number of decimal places displayed
- Convert the Reading to alternate units
- Reference measurements to other than Empty (P006) or Span (P007)

## P060 Decimal Position

Defines the maximum number of decimal places used on the LCD.

<b>Primary Index</b>	Level	
<b>Values</b>	0	No digits after the decimal point
	1	1 digit after the decimal point
	2 *	2 digits after the decimal point
	3	3 digits after the decimal point (limited by device resolution)

<b>Alters</b>		• P607 Flowrate Decimal
<b>Altered by</b>		• P051 Maximum volume
<b>Related</b>		• P920 Reading Measurement

In RUN mode, the decimal position adjusts to prevent the number of digits from exceeding the display capabilities. To keep the decimal place from shifting, reduce the number of decimal places to that shown at 100%.

**Example:**

If 100% is 15m, use two decimal places for sample readings of 15.00 or 12.15.

## P061 Convert Reading [MR 200]

*Multiplies the current value by the specified amount to allow for scaling.*

<b>Primary Index</b>	Level
<b>Values</b>	Range: -999 to 9999
	Preset: 1.000
<b>Related</b>	• P920 Reading Measurement

**Examples:**

- If the measured value is in feet, enter **0.3333** to display the number of yards
- For simple linear, volume conversions set P005 to **1** (meters) and then enter the volume measurement per unit to get the correct conversion. For example, if the reservoir contains 100 litres per vertical meter, use **100** to get the reading in litres.

**Notes:**

- This method does not calculate volume. It must not be used in place of the volume parameters if any volume dependent features (such as pump efficiency) are used. To calculate true volumes see *Volume* (P050 to P055).
- Avoid entering a value that, when multiplied by the maximum current Reading, exceeds the display capabilities. If value exceeds four digits, **EEEE** is shown.

## P062 Offset Reading

*Adds the specified value to the level reading, usually to reference the reading to sea level or another datum level.*

<b>Primary Index</b>	Level
<b>Values</b>	Range: -999 to 9999
	Preset: 0.000
<b>Related</b>	• P920 Reading Measurement

The operation of the device is not affected by the Offset Reading. This value is used for display purposes only. All control measurements are still referenced to Empty.

# Backup Level Override

Use this feature to override the ultrasonic reading by a discrete input such as a contacting point device. The ultrasonic reading will be fixed at the programmed switch level until the discrete input is released.

The ultrasonic device makes decisions based on the override values.

## P064 Reading Override Enable

*Sets the discrete input to act as the source for a level reading override.*

<b>Primary Index</b>	Transducer		
<b>Values</b>	0	*	OFF: No override.
	1-2		ON: Number = discrete input of override signal
<b>Related</b>	<ul style="list-style-type: none"><li>• P065 Reading Override Value</li><li>• P270 Discrete Input Function</li></ul>		

## P065 Reading Override Value

*This value is substituted for the current reading when the selected discrete input is enabled and activated.*

<b>Primary Index</b>	Transducer		
<b>Values</b>	Range: 0.0 to 99.00 m (or equivalent depending on units)		
	Preset: 0.00		
<b>Alters</b>	Current reading		
<b>Related</b>	<ul style="list-style-type: none"><li>• P001 Operation</li><li>• P005 Units</li><li>• P006 Empty</li><li>• P007 Span</li><li>• P064 Override Enable</li></ul>		

Please note the following:

- enter value in current units (as selected in P005)
- valid for level, space, and distance
- volume is calculated based on the Backup level

**Example:**

Transducer One is configured for a level measurement. Digital Input 2 is connected to a Hi Level Backup switch located a level of 4.3m.

Parameter	Index	Value
P064	1	2
P065	1	4.3

When the level rises to 4.3m, and the switch is activated, the reading is forced to 4.3m. The reading stays at 4.3m until the switch is de-activated.

## P066 Override Time Delay

*Defines the time used to calm (debounce) the override condition input. Set in seconds.*

<b>Primary Index</b>	Transducer
<b>Values</b>	Range: 0.0 to 9999 Preset: 5.0
<b>Related</b>	<ul style="list-style-type: none"><li>• P064 Override Enable</li><li>• P065 Reading Override Value</li><li>• P270 Discrete Input Function</li></ul>

**Note:** Activation of the Level Override is subject to the measurement cycle. This can add up to four seconds to the overall response time depending on operating conditions and programming.

## P069 Password

*Holds the current password for P000. Select by typing in **069**. You cannot scroll to this parameter.*

<b>Primary Index</b>	Global
<b>Values</b>	Range: 0 to 9999 Default: 1954
<b>Related</b>	<ul style="list-style-type: none"><li>• P000 Lock</li></ul>

This parameter is write-only, and can only be selected by entering **069**. To change the password, unlock the device by entering the current password into P000. Then enter the new password into P069. To lock the device, enter a password other than the correct one in P000. While the device is unlocked, the password is visible in P000.

# Failsafe (P070 to P072)

## P070 Failsafe Timer

*The time for invalid measurements to elapse before Failsafe State activates.*

Primary Index	Single Point Model	Dual Point Model
		Global
Values	Range: 0 to 15 minutes	
	Preset 10.00 minutes	
Altered by	<ul style="list-style-type: none"> <li>P003 Maximum Process Speed</li> </ul>	
Related	<ul style="list-style-type: none"> <li>P129 Relay Failsafe</li> </ul>	

### Once activated, the Failsafe State initiates the following:

- The material level is reported based on P071 Failsafe Material Level.
  - The unit responds to the new level as programmed (control and alarm relays activate as defined by the programming).
  - Individual relays can have independent failsafe responses. See *P129 Relay Failsafe*.
- The appropriate error is displayed:
  - LOE** for loss of echo from the transducer
  - Short** for a shorted transducer cable
  - Open** for a cut transducer cable
  - Error** for all other problems

When modifying the preset value, set it short enough to protect the process but long enough to avoid false alarms. Only use **No Delay (0.0 Minutes)** for testing.





## P071 Failsafe Material Level

*The material level reported when a Failsafe State is initiated.*

Primary Index	Level	
Values	Range: -4999 to 9999	Value in units or % (-50% to 150% of span)
	HI	Level goes to maximum span
	LO	Level goes to 0 span (Empty)
	HOLd *	Level remains at last reading
Related	<ul style="list-style-type: none"> <li>P001 Operation</li> <li>P006 Empty</li> <li>P007 Span</li> <li>P111 Relay Control Function</li> <li>P112 Relay ON Setpoint</li> <li>P113 relay OFF Setpoint</li> <li>P129 Relay Failsafe</li> </ul>	

Select the Failsafe Material Level based upon the relay operation required during failsafe operation.

## Selecting HI, LO, or HOLD

1. Press FUNCTION  to display the Auxiliary Function symbol.
2. Press ARROWS   to scroll to the desired option.
3. Press ENTER  to set the value.

## Entering a Measurement

To enter a specific Failsafe Material Level within -50 to 150% of Span (P007), in Units (P005).

## Relay reaction

The way in which relay programming reacts to the failsafe level depends on P129 Relay Failsafe (page 140). By default:

- Alarm relays have P129 = OFF and so react to the Failsafe Material Level.
- Control relays have P129 = **dE** and so de-energize the relay when the unit enters Failsafe mode regardless of the Failsafe Material Level.

## P072 Failsafe Level Advance

*Sets the speed the MultiRanger advances to and returns from the Failsafe Material Level.*

Primary Index	Level			
Values	1	*	Restricted	Advances to/from Failsafe Material Level as set by P003, P700 and P701.
	2		Immediate	Failsafe Material Level assumed right away
	3		Fast Back	Failsafe Level Advance is restricted, return is immediate
Related	<ul style="list-style-type: none"><li>• P003 Maximum Process Speed</li><li>• P070 Failsafe Timer</li><li>• P071 Failsafe Material Level</li><li>• P700 Max Fill rate</li><li>• P701 Max Empty rate</li></ul>			

## Relays (P100 to P119)

The MultiRanger has three or six relays (or digital outputs) used to control devices and alarms. While the number of devices is limited by the relays, all control functions are accessible through software and each parameter is indexed to the three or six relays. See the *Relay* section on page 41.

## Preset Applications (P100)

The MultiRanger makes standard applications easier to program by providing an extensive list of presets.

## Control Functions (P111)

Each relay can be configured independently to take advantage of the MultiRanger's advanced features and flexibility. Start with a preset application and then change the required parameters to make the task more efficient.

## Setpoints (P112, P113)

Each relay is triggered by one or more setpoints. The setpoints can be based on absolute level (P112, P113) or rate of change (P702, P703). Each control function specifies which setpoints are required.

# P100 Preset Applications [MR 200]

*Six preset applications to configure or bench test the unit.*

Primary Index	Global	
Values	0	* OFF
	1	Wet Well 1
	2	Wet Well 2
	3	Reservoir 1
	4	Reservoir 2
	5	Screen
	6	Alarms
Alters	<ul style="list-style-type: none"><li>• P110 Level Source</li><li>• P111 Relay Control Function</li><li>• P112 Relay On Setpoint</li><li>• P113 Relay OFF Setpoint</li><li>• P121 Pump by Rate</li></ul>	
Related	<ul style="list-style-type: none"><li>• P001 Operation</li></ul>	

Select an application that is similar to yours and change the parameters required. If none suit, then refer to P111 Relay Control Function on page 134.

**Note:** Programming the relays independently is the most common method used.

# P110 Level Source

*Sets the level source on which the indexed relay is assigned to a measurement point.*

Please note that Difference and Average settings are MultiRanger 200 features.

<b>Primary Index</b>	Relay		
<b>Values</b>	Range: 1 to 3		
	1	*	Point # 1 = Transducer One
	2		Point # 2 = Transducer Two
	3		Point # 3 = Difference (P001=4) or Average (P001=5)
<b>Altered by:</b>	<b>[MR 200]</b>	<b>[MR 200]</b>	<ul style="list-style-type: none"> <li>• P003 Maximum Process Speed</li> <li>• P700 Max Fill rate</li> <li>• P701 Max Empty rate</li> <li>• P070 Failsafe Timer</li> <li>• P071 Failsafe Material Level</li> </ul>

## MultiRanger 200

Please note that these features are only available on the MultiRanger 200.

### In Single Point Mode (standard):

Points 2 and 3 are available only if Operation is set for **difference** or **average** (P001 = 4 or 5).

### In Dual Point Mode (optional):

Point 2 is always available, and Point 3 is available only if Operation is set for **difference** or **average** (P001 = 4 or 5).

# P111 Relay Control Function

*Sets the control algorithm used to trip the relay.*

Please note that parameter P111 values vary between the MultiRanger 100 and the MultiRanger 200.

<b>Primary Index</b>	Relay
<b>Values</b>	See chart below
<b>Altered by</b>	<ul style="list-style-type: none"> <li>• P100 Preset Applications</li> </ul>

Use zero **0** (preset) to disable control of the indexed relay.

**Note:** All relay ON/OFF points must be referenced from Empty (P006), regardless of Operation Mode selection (P001).



## MultiRanger 100

Values For P111			
Control	Type	#1	Relay Control
General	OFF	0*	Relay set off, no action (preset)
	Level	1	Based on level setpoints ON and OFF
	Loss of Echo (LOE)	6	When echo is lost
	Cable Fault	7	When the circuit to a transducer is opened
Pump	Fixed Duty Assist	50	At fixed ON and OFF setpoints and allows multiple pumps to run
	Alternate Duty Assist	52	At rotating ON and OFF setpoints and allows multiple pumps to run
	Communication	65	Based on input from external communications. See <i>Communications</i> section on page 89 for further reference.

1. When reading and setting this parameter through Modbus or SmartLinX communications the parameter values are mapped to different numbers. See *MultiRanger Communications* on page 89 for Modbus information or the relevant SmartLinX<sup>®</sup> manual.

## MultiRanger 200

Values For P111			
Control	Type	#1	Relay Control
General	Off	0*	Relay set off, no action (preset)
	Level	1	Based on level setpoints ON and OFF
	In Bounds	2	When level enters the range between ON and OFF setpoints
	Out of Bounds	3	When level exits the range between ON and OFF setpoints
	Rate of Change	4	Based on rate setpoints ON and OFF
	Temperature	5	Based on temperature setpoints ON and OFF
	Loss of Echo (LOE)	6	When echo is lost
	Cable Fault	7	When the circuit to a transducer is opened
Flow	Totalizer	40	Every 10 <sup>y</sup> units (P641-P645)
	Flow Sampler	41	Every $y \times 10^2$ units (P641-P645) or time duration (P115)

		Values For P111	
Control	Type	# <sup>1</sup>	Relay Control
Pump	Fixed Duty Assist	50	At fixed ON and OFF setpoints and allows multiple pumps to run or for rake control
	Fixed Duty Backup	51	At fixed ON and OFF setpoints and allows only one pump to run
	Alternate Duty Assist	52	At rotating ON and OFF setpoints and allows multiple pumps to run
	Alternate Duty Backup	53	At rotating ON and OFF setpoints and allows only one pump to run
	Service Ratio Duty Assist	54	On service ratio at ON and OFF setpoints and allows multiple pumps to run
	Service Ratio Duty Backup	55	On service ratio at ON and OFF setpoints and allows only one pump to run
	First In First Out (FIFO)	56	As Alternate Duty Assist, resets the relay from staggered OFF setpoints
Control	Flush Valve	64	Used to control a pump flushing device based on Flush Systems (P170 to P173)
	Communication	65	Based on input from external communications. See <i>Communications</i> section on page 89 for further reference.

1. When reading and setting this parameter through Modbus or SmartLinX communications the parameter values are mapped to different numbers. See the *MultiRanger Communications* section on page 89 for Modbus information or the relevant SmartLinX<sup>®</sup> manual.

## P112 Relay ON Setpoint

*Sets the process point at which the relay changes from its NORMAL state.*

<b>Primary Index</b>	Relay
<b>Values</b>	Range: -999 to 9999
	Preset: ----
<b>Altered by</b>	<ul style="list-style-type: none"> <li>• P007 Span</li> </ul>
<b>Related</b>	<ul style="list-style-type: none"> <li>• P100 Preset Applications</li> <li>• P111 Relay Control Function</li> <li>• P113 Relay OFF Setpoint</li> </ul>

For most applications, the relay is tripped at this point. For IN-BOUNDS and OUT-OF-BOUNDS alarms, it is the high point in the specified range. This parameter is set according to Span (P007) even when another reading, such as volume, is shown on the LCD.

# P113 Relay OFF Setpoint

*Sets the process point at which the relay returns to its NORMAL state.*

<b>Primary Index</b>	Relay
<b>Values</b>	Range: -999 to 9999
	Preset: ----
<b>Altered by</b>	<ul style="list-style-type: none"><li>• P007 Span</li></ul>
<b>Related</b>	<ul style="list-style-type: none"><li>• P100 Preset Applications</li><li>• P111 Relay Control Function</li><li>• P112 Relay ON Setpoint</li></ul>

For most applications, the relay is reset at this point. For IN-BOUNDS and OUT-OF-BOUNDS alarms, it is the low point in the specified range. This parameter is set to Span (P007), even when another reading, such as volume, is shown on the LCD.

# P115 Relay Interval Setpoint [MR 200]

*The length of time in hours between starts.*

<b>Primary Index</b>	Relay
<b>Values</b>	Range: 0 to 9000 hours
	Preset: 0.000
<b>Altered by</b>	<ul style="list-style-type: none"><li>• P100 Preset Applications</li></ul>
<b>Related</b>	<ul style="list-style-type: none"><li>• P111 Relay Control Function</li></ul>

# P116 Dead Band [MR 200]

*The distance above and below the bound alarm setpoints.*

<b>Primary Index</b>	Relay
<b>Values</b>	Range: 0.000 to Span Value (P007), or equivalent depending on units
	Preset: 2% of span
<b>Related</b>	<ul style="list-style-type: none"><li>• P111 Relay Control Function</li><li>• P112 Relay ON Setpoint</li><li>• P113 Relay OFF Setpoint</li></ul>

For IN-BOUNDS and OUT-OF-BOUNDS Relay Functions (P111 = 2 and 3 respectively), a dead band prevents relay chatter due to material level fluctuations at both the upper and lower setpoints.

Enter the dead band in either percent of span or units of measure (P005). The dead band value is applied both above and below the upper and lower bound setpoints as shown in the figure.

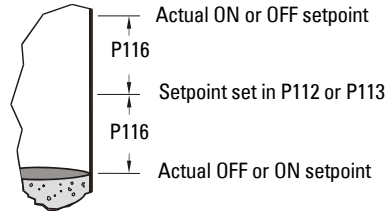

## P118 Relay Output Logic

*The logic applied to relays to determine the contact open or closed state.*

Primary Index	Relay					
Values	Value	Logic	Alarm Contact	Pump or Control Contact		
	2	*	Positive	Normally Closed	Normally Open	
	3		Negative	Normally Open	Normally Closed	
Related	<ul style="list-style-type: none"> <li>P111 Relay Control Function</li> </ul>					

The relay contact operation is **NORMALLY CLOSED** for alarms and **NORMALLY OPEN** for controls. See P111 *Relay Control Function* for more information.

**Note:** P118 is not reset by a master reset (P999).

### Power Failure

When power is cut to the MultiRanger, its relays fail to the following states:

Relay States	
Relay	Fail State
1,2,4,5	Open
3,6	Open or Closed <sup>1</sup>

- Relays 3 and 6 are Form C types, so you can wire it either **NORMALLY OPEN** or **NORMALLY CLOSED**. Check the wiring before programming.

To use relays 3 or 6 as general alarm indicators, set P118 to **3 – negative logic** and wire the alarm for normally open operation. When an alarm event occurs (see below) or when power is cut, the circuit closes and the alarm activates.

## Positive Logic

In software, all relays are programmed the same way, with ON setpoints indicating when to change the relay contact state (open or closed). This parameter allows the reversal of the operation so that relay contacts can be NORMALLY CLOSED or NORMALLY OPEN. P118 is preset to 2 which is positive logic.

## Negative Logic

When P118 = 3 (negative logic), the operation for the indexed relay is reversed from normal.

## P119 Relay Logic Test

*Forces the relay control logic into an ACTIVATED or DE-ACTIVATED state.*

Primary Index	Relay	
Values	0	* OFF - Control from MultiRanger algorithms
	1	Activate relay control
	2	De-activate relay control
Related	<ul style="list-style-type: none"><li>• P111 Relay Control Function</li><li>• P910 Toggle Relays</li></ul>	

This parameter tests site wiring and control logic programming. Forcing the relay to an activated or de-activated state is similar to the MultiRanger detecting an event and responding to it. Helpful in testing new installations and diagnosing control problems.

## Pump Setpoint Modifiers (P121 and P122) [MR 200]

Please note that these parameters apply to the MultiRanger 200 only.

These parameters provide alternate ways of starting the pumps in the pump group. See the *Pump Control* section on page 58 for descriptions of the pump control algorithms.

## P121 Pump by Rate [MR 200]

*Sets the pump relays to accept control by rate of level change once the first ON setpoint is reached.*

Primary Index	Single Point Model		Dual Point Model
	Transducer		Level
Values	0	* OFF (pump by level)	
	1	ON (pump by rate)	
Related	<ul style="list-style-type: none"><li>• P007 Span</li><li>• P111 Relay Control Function</li><li>• P132 Pump Start Delay</li><li>• Rate (P700 to P708)</li></ul>		

Use this function when multiple pumps are to be controlled by rate of level change rather than by setpoints.

The delay between pump starts is set by P132 Pump Start Delay.

This only applies to any relays set to pump control (P111 = 50 to 56).

**Notes:**

- All pump control relay ON and OFF setpoints must be the same value
- If the level is within 5% of Span (P007) of the OFF setpoint, the next pump is not started

## P122 Pump Service Ratio [MR 200]

*Selects pump usage based on the RUN time ratio rather than last used.*

<b>Primary Index</b>	Relay
<b>Values</b>	Range: 0.000 to 9999
	Preset: 20.00
<b>Related</b>	<ul style="list-style-type: none"><li>• P111 Relay Control Function</li></ul>

This parameter only relates to relays with P111 = 54 or 55.

To make this parameter useful, assign it to all of the pump relays. The number assigned to each pump relay represents the ratio applied to decide the next pump to start or stop.

**Notes:**

- The MultiRanger will not sacrifice other pumping strategies to ensure that the ratio is held true
- If the pump relays are set to the same value then the ratio equals 1:1 and all pumps are used equally (preset)

## Independent Relay Failsafe (P129)

### P129 Relay Failsafe

*Sets how individual relays react to a failsafe condition, to allow for more flexible programming.*





<b>Primary Index</b>	Relay		
<b>Values</b>	OFF	*	Response governed by P071 Failsafe Material Level
	HOLD		For LAST KNOWN relay state retention
	dE		To have the relay de-energize immediately on failsafe
	En		To have the relay energize immediately on failsafe
<b>Altered by</b>	<ul style="list-style-type: none"><li>• P071 Failsafe Material Level</li><li>• P070 Failsafe Timer</li><li>• P111 Relay Control Function</li></ul>		

Use this for operations independent of the Failsafe Material Level (P071).

Relay Failsafe is only available for the following relay functions (P111) and is not used for any other relay control function.

Relay Function (P111)	Preset (P129)
1 – level alarm	OFF
2 – in bounds alarm	
3 – out of bounds alarm	
4 – rate of change alarm	
5 – temperature alarm	
50 to 56 – all pump controls	dE

### To select an independent Relay Failsafe value:

1. Press FUNCTION  to display the Auxiliary Function symbol.
2. Press ARROWS   to scroll through the failsafe options.
3. Select option and press ENTER .

## Advanced Pump Control Modifiers (P130 to P137) [MR 200]

Please note that these parameters apply to the MultiRanger 200 only.

These parameters only affect relays set to pump operation (P111 = 50 to 56).

### P130 Pump Run-On Interval [MR 200]

*Sets the number of hours between pump run-on occurrences.*

<b>Primary Index</b>	Global
<b>Values</b>	Range: 0.000 to 1000
	Preset: 0.000
<b>Related</b>	<ul style="list-style-type: none"> <li>Advanced Pump Control Modifiers (P130 to P136)</li> </ul>

To clear sediment in a **pump-down** wet well, run the pump after the normal OFF setpoint is reached to force some solid material through. This parameter sets the time between such events. Only the last pump running can run-on.

## P131 Pump Run-On Duration [MR 200]

*Sets the number of seconds that the pump runs on.*

<b>Primary Index</b>	Relay
<b>Values</b>	Range: 0.0 to 9999
	Preset: 0.000
<b>Related</b>	<ul style="list-style-type: none"> <li>Advanced Pump Control Modifiers (P130 to P136)</li> </ul>

Your pump capacity determines the amount of material that can be removed. Choose a value long enough to clean out the vessel bottom, yet short enough not to run the pump dry. Also be sure that this value does not overlap with P130 (Interval). The timing should look something like this:

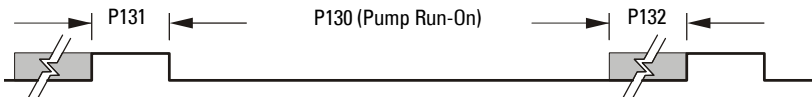

## P132 Pump Start Delay [MR 200]

*Sets the minimum delay (in seconds) between pump starts.*

<b>Primary Index</b>	Global
<b>Values</b>	Range: 0.0 to 9999
	Preset: 10 seconds
	Value is divided by 10 in simulation mode.
<b>Related</b>	<ul style="list-style-type: none"> <li>Advanced Pump Control Modifiers (P130 to P136)</li> <li>P121 Pump by Rate</li> </ul>

Use this feature to reduce a power surge from all pumps starting at the same time. This delay determines when the next pump is permitted to start.

## P133 Pump Power Resumption Delay [MR 200]

*Sets the minimum delay before the first pump restarts after power failure.*

<b>Primary Index</b>	Global
<b>Values</b>	Range: 0.000 to 9999
	Preset: 10 seconds
<b>Related</b>	<ul style="list-style-type: none"> <li>Advanced Pump Control Modifiers (P130 to P136)</li> <li>P132 Pump Start Delay</li> </ul>

This reduces the surge from the first pump starting immediately on power resumption. When this delay expires, other pumps will start as per P132.



# P136 Wall Cling Reduction [MR 200]

*Varies the upper and lower setpoints to reduce material buildup on the walls.*

Primary Index	Single Point Model		Dual Point Model	
		Global		Transducer
Values	Range: 0.000 to 9999			
	Preset: 0.000			

This value is the range in which the setpoints are allowed to deviate in percent or units. The Relay Setpoints ON and OFF values are randomly varied inside the range to ensure that the material level does not consistently stop at the same point.

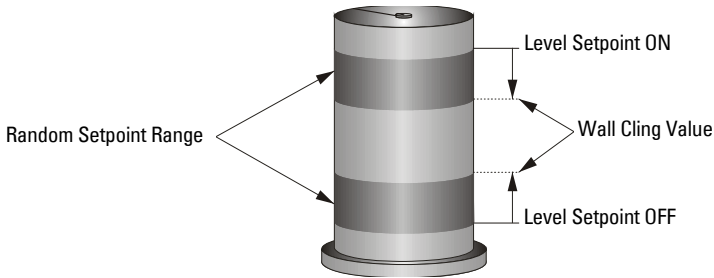

# P137 Pump Group [MR 200]

*Puts pumps into groups for multiple pump rotations on one transducer.*

Primary Index	Relay		
Values	Range: 1 to 2		
	1	*	group 1
	2		group 2
Alters	<ul style="list-style-type: none"> <li>P111 Relay Control Function when P111=52 (Alternate duty assist) or 53 (Alternate duty backup)</li> </ul>		

This feature groups pumps (relay points 1 - 6) into groups 1 or 2. It is applied to pump rotation and occurs independently within each group.

# Flush Systems (P170 to P173) [MR 200]

Please note that these parameters apply to the MultiRanger 200 only.

Use this feature to control an electrically operated flush valve on a pump to divert some pump output back into the wet well to stir up sediment.

## Notes:

- If any of the following parameters are set to **0**, this feature will not work.
- In Dual Point mode, a flush valve can be set up for each of the three available level inputs (P001 = **4** or **5**).

## Single Point Mode

Enter the MultiRanger relay number of the pump with the flush valve. The activation of this pump relay drives the usage of the flush system. Both P172 Flush Interval and P171 Flush Cycles are based on the operation of this relay and control any relay set to P111 = 64, Flush Valve.

## Dual Point Mode

The indexed relay is the one that controls the flush device. The value is the pump relay that is watched by the flush system. Enter the pump relay value into the parameter at the flush relay index.

## Example

If you need to watch pump Relay One to control a flush valve on Relay Two you would set P170[2]=1.

# P170 Flush Pump [MR 200]

*Picks the number of the pump relay which triggers the flushing device.*

Primary Index	Single Point Model	Dual Point Model
	Global	Relay
Values	Range: 0 to 6	
	Preset: 0	
Related	• P111 = 64, Flush Valve	

Enter the MultiRanger relay number of the pump with the flush valve. The activation of this pump relay drives the usage of the flush system. Both P172 Flush Interval [MR 200] and P171 Flush Cycles [MR 200] are based on the operation of this relay and controls any relay set to P111 = 64, Flush Valve.

## P171 Flush Cycles [MR 200]

*Sets the number of pump cycles requiring flush control.*

Primary Index	Single Point Model	Dual Point Model
		Global
Values	Range: 0 to 9999	
	Preset: 0	
Related	<ul style="list-style-type: none"> <li>P111 = 64, Flush Valve</li> </ul>	

**If three flush cycles are required after every ten pump cycles then:**

P172 (Flush Interval) = **10**

P171 (Flush Cycles) = **3**

## P172 Flush Interval [MR 200]

*Sets the number of pump cycles before flush control is enabled.*

Primary Index	Single Point Model	Dual Point Model
		Global
Values	Range: 0 to 9999	
	Preset: 0	
Related	<ul style="list-style-type: none"> <li>P111 = 64, Flush Valve</li> </ul>	

To start a new flush cycle every ten times the pumps are run, set this to **10**.

## P173 Flush Duration [MR 200]

*The length of time for each flush cycle that the flush control is active.*

Primary Index	Single Point Model	Dual Point Model
		Global
Values	Range: 0.000 to 9999 s	
	Preset: 0.000	
Related	<ul style="list-style-type: none"> <li>P111 = 64, Flush Valve</li> </ul>	

# mA Output (P200 to P219)

## P200 mA Output Range

*Determines the mA output range.*

Primary Index	mA output		
Values	0		off
	1		0 to 20 mA
	2	*	4 to 20 mA
	3		20 to 0 mA
	4		20 to 4 mA
Related	• P911 mA Output Value		

If either **1** or **2** is selected, the mA output is directly proportional to the mA Function. If either **3** or **4** is selected, then the output is inversely proportional. After setting P200, verify that P212 has a valid entry for mA Output Min Limit, as P212 is not changed automatically by a change to P200.

## P201 mA Output Function

*Alters the mA output/measurement relationship.*

Please note that parameter P201 values vary between the MultiRanger 100 and the MultiRanger 200.

### MultiRanger 100

Primary Index	mA output		
Values	value	mA function	Operation (P001)
	0	OFF	
	1	level	level
	2	space	space
	3	distance	distance
Related	• P202 mA Output Allocation • P911 mA Output Value		
Altered By	• P001 Operation		

## MultiRanger 200

Primary Index	mA output		
Values	value	mA function	Operation (P001)
	0	OFF	
	1	level	level, differential, or average
	2	space	space
	3	distance	distance
	4	volume	level or space
	5	flow	OCM
	6	head	
	7	volume rate	
	8	mA input	
9	comms input		
Related	<ul style="list-style-type: none"> <li>P202 mA Output Allocation</li> <li>P911 mA Output Value</li> </ul>		
Altered By	<ul style="list-style-type: none"> <li>P001 Operation</li> </ul>		

## P202 mA Output Allocation

*Sets the input source from which the mA output is calculated.*

Please note that parameter P202 values vary between the MultiRanger 100 and the MultiRanger 200.

### MultiRanger 100

Primary Index	mA output		
Values	1	*	Point 1
	2		Point 2
	1:2		Average of readings from Point 1 and Point 2
Related	<ul style="list-style-type: none"> <li>P201 mA Output Function</li> </ul>		

### MultiRanger 200

Primary Index	mA output		
Values	1	*	Point 1
	2		Point 2
	1:2		Average of readings from Point 1 and Point 2
	3		Point 3
Related	<ul style="list-style-type: none"> <li>P201 mA Output Function</li> </ul>		

Enter the Point Number the mA output is based on. This value depends on whether mA function (P201) is set as transducer or mA input.

For a single point device, if P201 uses a transducer, parameter P202 can only be altered if P001 (Operation) is set for DPD or DPA.

P202 can be set to a particular point or range of points. When set to a range of points, the mA output will be the average of the readings from all in service transducers in the range. Out of service transducers will be ignored.

If P202 mA Output Allocation End contains the value 0, then only 1 transducer has been assigned to the mA output.

## P203 mA Output Value / Transducer

*Displays current mA output value for the Point Number.*

<b>Primary Index</b>	Level
<b>Values</b>	Range: 0.000 to 22.00 (view only)

This displays as an Auxiliary Reading when  key is pressed in the RUN mode and does not include adjustments made using Trim features (P214 / P215).

P203 holds the mA value associated with a transducer. This value is used for run mode display of the mA output. When only one mA output is associated with a transducer, this parameter holds the value of that mA output. When more than one transducer is associated with a mA output (set via P202), P203 holds the mA output calculated from the resulting average of the associated transducer readings. When more than one mA output is associated with a transducer, P203 holds the value of the first mA output associated with the transducer.

**Note:** This parameter is applicable only if any mA output has the transducer Point Number as its input source (see P201 and P202).

# Independent mA Setpoints (P210 and P211)

Use these features to reference the minimum and/or maximum mA output to any point in the measurement range.

P201—mA Function Settings	Action
Level, Space, or Distance	Enter the material level in Units (P005) or percent of Span (P007) as referenced to Empty (P006).
Volume [MR 200]	Enter the volume in Max Volume (P051) units or as a percent of Max Volume.
Flow [MR 200]	Enter the flowrate in OCM Max Flow (P604) units or as a percent of OCM Max Flow.
Head [MR 200]	Enter the head in level units (P005) or percent of Max Head (P603).
Volume Rate [MR 200]	Enter the volume rate in volume/min. Ensure the % symbol is displayed before attempting to enter a % value.
mA input or Communications Input	Not Applicable

## P210 0/4 mA Output Setpoint

*Sets the process level corresponding to the 0 or 4mA value.*

<b>Primary Index</b>	mA output
<b>Values</b>	Range: -999 to 9999
<b>Related</b>	<ul style="list-style-type: none"> <li>P211 20 mA Output Setpoint</li> </ul>

Enter the value (in applicable units or %) to correspond to 0 or 4 mA.

## P211 20 mA Output Setpoint

*Sets the process level that corresponds to the 20 mA value.*

<b>Primary Index</b>	mA output
<b>Values</b>	Range: -999 to 9999
<b>Related</b>	<ul style="list-style-type: none"> <li>P210 0/4 mA Output Setpoint</li> </ul>

Enter the value (in applicable units or %) to correspond to 20 mA.

## mA Output Limits (P212 and P213)

Use these features to adjust the minimum and/or maximum mA output values, which should suit the input limit requirements of the external device.

## P212 mA Output Min Limit

*Sets the minimum mA output value (in mA) to be produced.*

<b>Primary Index</b>	mA output
<b>Values</b>	Range: 0.000 to 22.00
	Preset: 3.8
<b>Related</b>	<ul style="list-style-type: none"><li>• P200 mA Output Range</li><li>• P213 mA Output Max Limit</li></ul>

## P213 mA Output Max Limit



*Sets the maximum mA output value (in mA) to be produced.*

<b>Primary Index</b>	mA output
<b>Values</b>	Range: 0.000 to 22.00
	Preset: 20.2 mA
<b>Related</b>	<ul style="list-style-type: none"><li>• P200 mA Output Range / P212 mA Output Min Limit</li></ul>

## mA Output Trim (P214 to P215)

This does not affect the P203 value shown, and is used when recalibration of an external device is impractical.

To adjust the value so that the device correctly indicates 4.00 (when P214 is accessed) or 20.00 mA (when P215 is accessed):

1. Attach ammeter to MultiRanger 4 to 20 mA output.
2. Access P214, Index 1 (for mA output 1) or 2 (for mA output 2). Press CLEAR and ENTER  . The ammeter should show a value near 4 mA.
3. Enter the exact value displayed on the ammeter into P214 (Index 1 or 2).
4. The ammeter should then read exactly 4.00 mA.
5. Repeat steps 1 to 4 to set P215, using 20 mA as the desired value.

## P214 4 mA Output Trim

*Calibrates the 4 mA output.*

<b>Primary Index</b>	mA output
<b>Values</b>	Preset: 4.00
<b>Related</b>	<ul style="list-style-type: none"><li>• P215 20 mA Output Trim</li></ul>

Adjust this value so the device indicates 4.000 mA when P214 is accessed.



# P215 20 mA Output Trim

*Calibrates the 20 mA output.*

<b>Primary Index</b>	mA output
<b>Values</b>	Preset: 20.00
<b>Related</b>	<ul style="list-style-type: none"><li>• P214 4mA Output Trim</li></ul>

Adjust this value so the device indicates 20.00 mA when P215 is accessed.

## mA Output Failsafe (P219) [MR 200]





Please note that this parameter applies to the MultiRanger 200 only.

### P219 mA Output Failsafe [MR 200]

*Use for failsafe operation, independent of the Failsafe Material Level (P071).*

<b>Primary Index</b>	mA output		
<b>Values</b>	Range: 0.000 to 22.00		
	OFF	*	mA output responds to Failsafe Material Level (P071).
	HOLd		last <b>known</b> value is held until normal operation resumes
	LO		produce the <b>Empty</b> mA output immediately
	HI		produce the <b>Span</b> mA output immediately
<b>Related</b>	<ul style="list-style-type: none"><li>• P201 mA Output Function</li></ul>		

#### Selecting an independent mA Failsafe option:

1. Press MODE  to display the Auxiliary Function symbol.
2. Press ARROWS   to scroll access the failsafe options.
3. Press ENTER  when the desired option displayed.

Or, to produce an mA output at a specific value, enter the value required. This is used only if mA output is allocated to a transducer (P201 = 1 to 7).

## mA Input (P250 to P260) [MR 200]

Please note that these parameters apply to the MultiRanger 200 only.

## P250 mA Input Range [MR 200]

*Shows the mA input range of the connected mA device.*

<b>Primary Index</b>	Global		
<b>Values</b>	1		0 to 20 mA
	2	*	4 to 20 mA

Ensure this range corresponds to the output range of the external device. All level measurements will equate % of Span with the % of the mA range.

## P251 0 or 4 mA Input Level [MR 200]

*Shows the process level corresponding to the 0 or 4 mA value.*

<b>Primary Index</b>	Global		
<b>Values</b>	Range: -999 to 9999%		
	Preset: 0%		
<b>Related</b>	<ul style="list-style-type: none"><li>• P006 Empty</li><li>• P007 Span</li></ul>		

When using an external mA signal to determine level, the input range must be scaled to give accurate results.

## P252 20 mA Input Level [MR 200]

*Shows the process level corresponding to the 20 mA value.*

<b>Primary Index</b>	Global		
<b>Values</b>	Range: -999 to 9999%		
	Preset: 100%		
<b>Related</b>	<ul style="list-style-type: none"><li>• P006 Empty</li><li>• P007 Span</li></ul>		

Input range is scaled for accuracy if an external mA signal calculates level.

## P253 Input Filter Time Constant [MR 200]

*Shows the time constant used in the mA input filter to dampen signal fluctuations.*

<b>Primary Index</b>	Global
<b>Values</b>	Range: 0 to 9999
	Preset: 1

This number in seconds is used in the damping calculations. Larger values damp more than smaller values and **0** disables the signal filter.

## P254 Scaled mA Input Value [MR 200]

*Shows the resulting level value after scaling.*

<b>Primary Index</b>	Global
<b>Values</b>	Range: -999 to 9999% (view only)
	Preset: calculated from the input mA signal

This parameter is calculated from the input mA signal.

## P260 mA Raw Input [MR 200]

*Shows the raw mA input supplied by the external device.*

<b>Primary Index</b>	mA input
<b>Values</b>	Range: 0.000 to 20.00 (view only)

## Discrete Input Functions (P270 to P275)

Discrete inputs can be used for the following:

- Passing other information to a remote system through communications
- Backup level override

Use the parameters listed above to have discrete inputs modify the unit's operation.

Use the following parameters to configure the discrete input itself.

See also the *Pump Control* section on page 58 for a description of the MultiRanger's pump control algorithms, including how the discrete inputs alter its operation.

## P270 Discrete Input Function

*Sets how discrete signals are interpreted by the MultiRanger.*

<b>Primary Index</b>	Discrete input	
<b>Values</b>	0	Forced <b>OFF</b>
	1	Forced <b>ON</b>
	2 *	Normally Open – 0 (DI open), 1 (DI closed)
	3	Normally Closed – 0 (DI closed), 1 (DI open)
<b>Related</b>	<ul style="list-style-type: none"> <li>Pump Control section</li> </ul>	

## P275 Scaled Discrete Input Value

*Shows the current value of the discrete input after any scaling is applied.*

<b>Primary Index</b>	Discrete input	
<b>Values</b>	Display: view only	
	Values: dependent on the function of the discrete input	
	<b>Range of Values</b>	<b>Function (P270)</b>
	1	Forced <b>ON</b>
	0	Forced <b>OFF</b>
	0 (DI open), 1 (DI closed)	Normally Open
	0 (DI closed), 1 (DI open)	Normally Closed

Readings are updated continuously even in PROGRAM mode. The value signals a level override event.

## Standard Data Logging (P300 to P321)

All records can be reset by pressing the CLEAR   keys.

## Record Temperatures (P300 to P303)



These features display the high and/or low temperatures in °C. When a parameter relating to a TS-3 Temperature Sensor is accessed, the Point Type display changes to the TS-3 symbol .

If the unit is powered up without a temperature sensor connected, the value –50°C is displayed. This information can help trace problems with both built in and external temperature sensors.

## P300 Temperature, Transducer Maximum

*Shows the highest temperature encountered, as measured by the temperature sensor in the transducer (if applicable).*



<b>Primary Index</b>	Transducer
<b>Values</b>	Range: - 50 to 150°C (view only)
	Preset: - 50°C
<b>Related</b>	<ul style="list-style-type: none"><li>• P301 Temperature, Transducer Min</li></ul>

Press CLEAR   keys to reset the log after a short circuit on the transducer wiring.

## P301 Temperature, Transducer Minimum

*View the lowest temperature encountered, as measured by the temperature sensor in the transducer (if applicable).*



<b>Primary Index</b>	Transducer
<b>Values</b>	Range: - 50 to 150°C (view only)
	Preset: 150°C
<b>Related</b>	<ul style="list-style-type: none"><li>• P300 Temperature, Transducer Max</li></ul>

Press CLEAR   keys to reset the log after an open circuit on the transducer wiring.

## P302 Temperature, Sensor Maximum

*View the highest temperature encountered, as measured by the TS-3 Temperature Sensor (if applicable).*



<b>Primary Index</b>	Global
<b>Values</b>	Range: - 50 to 150°C (view only)
	Preset: - 50°C
<b>Related</b>	<ul style="list-style-type: none"><li>• P303 Temperature, Sensor Min</li></ul>

Press CLEAR   keys to reset the log after a short circuit on the transducer wiring.



## P303 Temperature, Sensor Minimum

*Shows the lowest temperature encountered, as measured by the TS-3 Temperature Sensor (if applicable).*

<b>Primary Index</b>	Global
<b>Values</b>	Range: - 50 to 150°C (view only)
	Preset: 150°C
<b>Related</b>	<ul style="list-style-type: none"><li>• P302 Temperature, Sensor Max</li></ul>

Press CLEAR   keys to reset the log after an open circuit on the transducer wiring.

## Record Readings (P304 and P305)

This identifies the occurrence of the record high and low level readings. Press CLEAR   keys to reset these values once the installation is working correctly.

### P304 Reading Max

*Shows the highest Reading calculated (in normal Reading units or %).*

<b>Primary Index</b>	Level
<b>Values</b>	Range: -999 to 9999 (view only)
<b>Related</b>	<ul style="list-style-type: none"><li>• P305 Reading Min</li></ul>

### P305 Reading Min

*Shows the lowest Reading calculated (in normal Reading units or %).*

<b>Primary Index</b>	Level
<b>Values</b>	Range: -999 to 9999 (view only)
<b>Related</b>	<ul style="list-style-type: none"><li>• P304 Reading Max</li></ul>

## Pump Records (P309 to P312)

These features to identify pump usage and if the associated Relay Function (P111) is set for any **pump control** feature. The value is that of the pump connected to the associated terminals.

Enter a value to set the current record to that value. Use this if a pump is added with a known number of hours logged, or the value can be reset to zero **0** after maintenance.

## P309 Pump RUN Time

*Displays the amount of time in minutes since a relay was last activated.*

<b>Primary Index</b>	Relay
<b>Values</b>	Range: 0 to 9999 minutes (view only)
<b>Related</b>	<ul style="list-style-type: none"><li>Relay Function (P111) set for any pump control feature</li></ul>

Parameter measures the length of time since a relay was asserted, most often to determine how long a pump has been running. Alternatively, it can monitor a relay to show how long it has been in a state of alarm. It resets every time the relay is activated.

## P310 Pump Hours

*View or reset the accumulate ON time for the displayed Relay Number.*

<b>Primary Index</b>	Relay
<b>Values</b>	Range: 0.000 to 9999
<b>Related</b>	<ul style="list-style-type: none"><li>Relay Function (P111) set for any <b>pump control</b> feature</li></ul>

Value is displayed with a floating decimal point (the more figures displayed before the decimal, the fewer displayed after). It is the value displayed when  key is pressed in the RUN mode.

## P311 Pump Starts

*View or reset the accumulated number of times the Relay Number has been ON.*

<b>Primary Index</b>	Relay
<b>Values</b>	Range: 0 to 9999
<b>Related</b>	<ul style="list-style-type: none"><li>Relay Function (P111) set for any <b>pump control</b> feature</li></ul>

This value is displayed when  key is pressed and held for five seconds in RUN mode.

## P312 Pump Run Ons [MR 200]



*View or reset the accumulated number of times the displayed Relay Number has been held ON via Run On Interval (P130).*

Please note that this parameter applies to the MultiRanger 200 only.

<b>Primary Index</b>	Relay
<b>Values</b>	Range: 0 to 9999
<b>Related</b>	<ul style="list-style-type: none"><li>Relay Function (P111) set for any <b>pump control</b> feature</li></ul>

# Flow Records (P320 and P321) [MR 200]

Please note that these parameters apply to the MultiRanger 200 only.

These features are enabled if Operation is set for OCM (P001 = 6), or an OCM device is defined (P600 ≠ 0). Use them to identify the occurrence of the record high and low flow rates as displayed in OCM Max Flow (P604) units, or as a percent of OCM Max Flow. Press CLEAR   keys to reset values once the installation is working correctly.

## P320 Flow Max [MR 200]

*View the highest flow rate calculated (in units or %).*

Primary Index	Single Point Model	Dual Point Model
	Global	Transducer
Values	Range: -999 to 9999 (view only)	
Related	• P604 Maximum Flow	

## P321 Flow Min [MR 200]

*View the lowest flow rate calculated (in units or %).*

Primary Index	Single Point Model	Dual Point Model
	Global	Transducer
Values	Range: -999 to 9999 (view only)	
Related	• P604 Maximum Flow	

## LCD Totalizer (P322 and P323) [MR 200]

Please note that these parameters apply to the MultiRanger 200 only.

Use these features to view, reset, or preset the eight-digit display totalizer when Operation is set for OCM or Pumped Volume (P001 = 6 or 7). The eight-digit totalizer is divided into two groups of four digits. The four least significant totalizer digits are stored in P322, and the four most significant digits are stored in P323. Adjust these values separately to set a new total.

### Example

P323 = 0017

P322 = 6.294

Totalizer Display = 00176.294



Totalizer units are dependent upon programming. Enter zero **0** (if required) to reset the totalizer to zero. Alternatively, enter any other (applicable) value, to preset the totalizer to the necessary value.

**Note:** A second point is available only if the Dual Point Feature is enabled.

## P322 LCD Total Low [MR 200]

*View and/or alter the four least significant digits of the totalizer value.*

Primary Index	Single Point Model	Dual Point Model
		Global
Values	Range: 0.000 to 9999	
Related	<ul style="list-style-type: none"> <li>• P630 LCD Totalized Multiplier</li> <li>• P633 LCD Totalized Decimal Position</li> <li>• P737 Primary Reading</li> </ul>	

## P323 LCD Total High [MR 200]

*View and/or alter the four most significant digits of the totalizer value.*

Primary Index	Single Point Model	Dual Point Model
		Global
Values	Range: 0.000 to 9999	
Related	<ul style="list-style-type: none"> <li>• P630 LCD Totalized Multiplier</li> <li>• P633 LCD Totalized Decimal Position</li> <li>• P737 Primary Reading</li> </ul>	

## Profile Records (P330 to P337)

### **WARNING:**

**These parameters are for authorized service personnel or technicians familiar with Siemens Milltronics echo processing techniques.**

These features can record up to ten Echo profiles, initiated manually (P330), or automatically (P331 et al). If ten Profiles are already saved, addresses 1 through 10 are filled, the oldest automatically initiated record is overwritten. Manually initiated records are not automatically overwritten. All records are automatically deleted in the event of a power interruption.

When a record is displayed, results are based on current programming (which may have been altered since the record was saved). This permits the effect on the echo profile to be observed when changing an echo parameter.

# P330 Profile Record



*Records profiles for later viewing.*

Primary Index	Echo profile	
Values	Code	Description
	----	no record
	A1	automatically recorded profile from Transducer One
	A2	automatically recorded profile from Transducer Two
	U1	manually recorded profile from Transducer One
	U2	manually recorded profile from Transducer Two

**In addition to being a profile records library, this provides two functions:**

- manually records and saves echo profiles
- displays an echo profile, recorded manually or automatically

## To select a record address

1. Enter PROGRAM mode and press DISPLAY  twice to highlight the index field. The field shows two underscores \_ \_.
2. Type the index number. The profile record information is shown.
3. Use ARROWS   to scroll through the records.

## To manually record a profile

Press TRANSDUCER  to fire the transducer and record the echo profile into the internal buffer for display.

## MultiRanger 100 and MultiRanger 200 Features

### To save a manual record



Press ENTER  to copy the echo profile record in the buffer and save it in the selected address in the record library. The parameter value field displays the new record information.

### To display a record

Press  key to enter display auxiliary mode and then:

- Press TRANSDUCER  to copy the current echo profile into the buffer for display on Dolphin Plus

### To delete a record

Press CLEAR  and then ENTER  to delete the echo profile record in the selected address. The value returns to - - -.

## P331 Auto Record Enable

Use to enable/disable the Auto Profile Record function.

<b>Primary Index</b>	Global		
<b>Values</b>	Range: 0 to 1		
	0	*	Off
	1		On

## P332 Auto Record Transducer

Specifies the Transducer Point Number for which Auto Profile Records are saved.

Please note that Differential and Average operation is a MultiRanger 200 feature.

<b>Primary Index</b>	Global		
<b>Values</b>	Range: 0 to 2		
	0		Any transducer
	1	*	Transducer One
	2		Transducer Two
<b>Altered By</b>	• P001 Operation = 4 or 5		

### MultiRanger 200

This feature is preset to Point Number 1. (Alteration is only required if **differential** or **average** Operation [P001 = 4 or 5] is selected.)

## P333 Auto Record Interval

Enter the time to elapse after an Auto Profile Record is saved before another Auto Profile Record can be saved (subject to all other restrictions).

<b>Primary Index</b>	Global		
<b>Values</b>	Range: 0.0 to 166.6 (minutes)		
	Preset: 120		

# Auto Record ON and OFF Setpoints (P334 to P337)

Use Auto Record ON Setpoint (P334) and Auto Record OFF Setpoint (P335) to define the boundaries within which the level must be, for the resultant Echo Profile to be considered for an Auto Profile Record.

If ---- is displayed for either P334 or P335, Auto Profile Records are saved regardless of current level (subject to all other restrictions).

Enter the level value in Units (P005) or percent of Span (P007) as referenced to Empty (P006).

## P334 Auto Record ON Setpoint

*Enter the critical level which, in conjunction with Auto Record OFF Setpoint, defines the boundaries for Auto Profile Records to be saved.*

<b>Primary Index</b>	Global
<b>Values</b>	Range: -999 to 9999
<b>Related</b>	<ul style="list-style-type: none"><li>• P335 Auto Record OFF Setpoint</li><li>• P336 Auto Record Filling / Emptying</li><li>• P337 Auto Record LOE Time</li></ul>

## P335 Auto Record OFF Setpoint

*Enter the critical level which, in conjunction with Auto Record ON Setpoint, defines the boundaries for Auto Profile Records to be saved.*

<b>Primary Index</b>	Global
<b>Values</b>	Range: -999 to 9999
<b>Related</b>	<ul style="list-style-type: none"><li>• P334 Auto Record <b>ON</b> Setpoint</li><li>• P336 Auto Record Filling / Emptying</li><li>• P337 Auto Record LOE Time</li></ul>

## P336 Auto Record Filling / Emptying

Use this feature to restrict Auto Profile Records from being saved unless the level is rising, falling or either.

<b>Primary Index</b>	Global		
<b>Values</b>	0	*	Auto Profile Record on filling or emptying
	1		Auto Profile Record on filling only
	2		Auto Profile Record on emptying only
<b>Related</b>	<ul style="list-style-type: none"> <li>• P334 Auto Record ON Setpoint</li> <li>• P335 Auto Record OFF Setpoint</li> <li>• P337 Auto Record LOE Time</li> <li>• P702 Filling Indicator</li> <li>• P703 Emptying Indicator</li> </ul>		

If the level changes at a rate in excess of the corresponding Filling / Emptying Indicator (P702 / P703) values, the Echo Profile is saved subject to this and other Auto Profile Record restrictions.

## P337 Auto Record LOE Time

Limits Auto Profile Records from being saved unless extended LOE occurs.

<b>Primary Index</b>	Global		
<b>Values</b>	Range: 0.0 to 9999 (seconds)		
	Preset: 0.0		
<b>Related</b>	<ul style="list-style-type: none"> <li>• P334 Auto Record ON Setpoint</li> <li>• P335 Auto Record OFF Setpoint</li> <li>• P336 Auto Record Filling / Emptying</li> </ul>		

If the LOE condition exceeds the period entered, the Echo Profile is saved. When set for LOE is not required for an Auto Profile Record to be saved.

# Installation Records (P340 to P342)

## P340 Date of Manufacture

*View the date of manufacture of this MultiRanger unit.*

<b>Primary Index</b>	Global
<b>Values</b>	Format: YY:MM:DD (view only)
<b>Related</b>	<ul style="list-style-type: none"><li>• P340 Date of Manufacture</li><li>• P342 Start Ups</li></ul>

## P341 RUN Time

*View the number of days this MultiRanger has been in operation.*

<b>Primary Index</b>	Global
<b>Values</b>	Range: 0.000 to 9999 (view only)
<b>Related</b>	<ul style="list-style-type: none"><li>• P340 Date of Manufacture</li><li>• P342 Start Ups</li></ul>

The RUN Time value is updated once a day, and cannot be reset. However, in the event of a power interruption, the counter won't advance. Therefore, a unit that is powered down on a regular basis will not have an accurate value.

## P342 Start Ups

*The number of times power has been applied since the Date Of Manufacture.*

<b>Primary Index</b>	Global
<b>Values</b>	Range: 1 to 9999 (view only)
<b>Related</b>	<ul style="list-style-type: none"><li>• P340 Date of Manufacture</li><li>• P342 Run Time</li></ul>

# Open Channel Monitoring (P600 to P621) [MR 200]

Open Channel Monitoring (OCM) operation is a MultiRanger 200 feature only.

If the MultiRanger is used to monitor open channel flow, alter the following parameters as required and run a calibration as described in P621.

**Note:** See *Open Channel Monitoring* (OCM) on page 73 for application examples involving common weirs and flumes.

The MultiRanger measures **head** as referenced to Empty (P006) or OCM Zero Offset (P605), when Operation is set for **OCM** (P001 = 6). Flowrate, based on head (at the **point of measure** specified by the Primary Measuring Device fabricator) is also calculated and displayed on the LCD.

Some Primary Measuring Devices require a longer Range Extension (P801) to avoid entering the LOE failure state if the water level falls below the zero point of the Primary Measuring Device. See *P801 Range Extension* on page 200 for more information.

## P600 Primary Measuring Device [MR 200]

*The type of primary measuring device (PMD) used.*

Primary Index	Single Point Model		Dual
	Global		Transducer
Values	0	*	off (no calculation)
	1		Exponential (see P601)
	2		Palmer-Bowlus Flume (see P602)
	3		H-Flume (see P602)
	4		Universal Linear Flow Calculation (see P610, P611)
	5		Universal Curved Flow Calculation (see P610, P611)
	6		BS-3680/ISO 4359 Rectangular Flume (see P602)
	7		BS-3680/ISO 1438/1 Thin Plate V-Notch Weir (see P602)
Alters	<ul style="list-style-type: none"> <li>• P601 Flow Exponent</li> <li>• P602 Primary Measuring Device Dimensions</li> <li>• P608 Flowrate Units</li> </ul>		
Altered By	<ul style="list-style-type: none"> <li>• P001 Operation</li> </ul>		
Related	<ul style="list-style-type: none"> <li>• P603 Maximum Head</li> <li>• P604 Maximum Flow</li> <li>• P605 Zero Head</li> <li>• P610 Head Breakpoints</li> <li>• P611 Breakpoint</li> </ul>		

The MultiRanger is pre-programmed for common PMD flow calculations. If your PMD is not listed, select the appropriate Universal Flow Calculation.

Associated parameters Max Head (P603), Max Flow (P604), and Min Head (P605) may be scroll accessed. If Operation is not set for **OCM** (P001 = 6), this value is preset to **0**. If Operation is set for **OCM**, it is preset to **1**.

## P601 Flow Exponent [MR 200]

*The Exponent for the flow calculation formula.*

Primary Index	Single Point Model		Dual
		Global	
Values	Range: -999 to 9999		
	Preset: 1.55		
Altered By	<ul style="list-style-type: none"> <li>P600 Primary Measuring Device</li> </ul>		
Related	<ul style="list-style-type: none"> <li>P603 Maximum Head</li> <li>P604 Maximum Flow</li> <li>P605 Zero Head</li> </ul>		

Use this parameter if the Primary Measuring Device (P600) is set to 1 (exponential). It creates an exponential curve with end points set by Max Head (P603) and Zero Head (P604) and with the curve based on the specified exponent.

If P601 = 1, the flow characteristic is a straight line

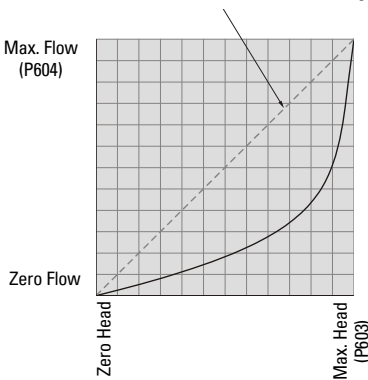

### A Word on Exponents

The exponential equation is  

$$Q = KH^{P601}$$

Where:

Q = flow

K = internal constant

H = head

Use the exponent specified by the PMD manufacturer, if available, or the sample value given below.



## Example Exponents

PMD Type	Exponent (sample only)
Suppressed Rectangular Weir	1.50
Cipolletti Weir	1.50
Venturi Flume	1.50
Parshall Flume	1.22 to 1.607
Leopold Lagco	1.547
V-Notch Weir	2.50

## P602 Primary Measuring Device Dimensions [MR 200]

*The dimensions of the Primary Measuring Device (PMD).*

Primary Index	Single Point Model		Dual Point Model		
	Global		Transducer and Dimension		
Secondary Index	Dimension				
Index Values for Supported PMDs	<b>ISO 1438/1</b>				
	1	Notch Angle			
	2	Discharge Coefficient			
	<b>ISO 4359</b>				
	1	Approach width			
	2	Throat width			
	3	Hump Height			
	4	Throat Length			
	5	Velocity coefficient			
	6	Discharge coefficient			
	<b>Palmer Bowlus</b>				
	1	Flume width			
	<b>H Flume</b>				
	1	Flume height			
	Altered By	<ul style="list-style-type: none"> <li>P600 Primary Measuring Device</li> </ul>			

Use this parameter if the Primary Measuring Device is directly supported (P600=2,3,6,7). The dimensions required for each PMD vary.

For more information on PMD, see page 73.

## P603 Maximum Head [MR 200]

*The level value associated with Maximum Flow, in Units (P005).*

Primary Index	Single Point Model	Dual Point Model
	Global	Transducer
Values	Range: -999 to 9999	
	Preset: Span (P007) value	
Altered By	<ul style="list-style-type: none"><li>• P005 Units</li><li>• P600 Primary Measuring Device</li></ul>	
Related	<ul style="list-style-type: none"><li>• P604 Maximum Flow</li><li>• P605 Zero Head</li></ul>	

This represents the highest head level supported by the PMD and works in conjunction with Maximum Flow (P604) to define the highest point in the exponential curve. Use it when the Primary Measuring Device (PMD) requires a maximum head and flow reference point. This would include Exponential, Palmer Bowlus Flume, H-Flume, and Universal breakpoints.

## P604 Maximum Flow [MR 200]

*The maximum flowrate associated with Maximum Head (P603).*

Primary Index	Single Point Model	Dual Point Model
	Global	Transducer
Values	Range: -999 to 9999	
	Preset: 1000	
Altered By	<ul style="list-style-type: none"><li>• P600 Primary Measuring Device</li></ul>	
Related	<ul style="list-style-type: none"><li>• P603 Maximum Head</li><li>• P606 Time Units</li><li>• P925 Flow Measurement</li></ul>	

This represents the flow at the highest head level supported by the PMD. and works in conjunction with Maximum Head (P603) to define the highest point in the exponential curve. Use it when the Primary Measuring Device (PMD) requires a maximum head and flow reference point. This would include Exponential, Palmer Bowlus Flume, H-Flume, and Universal breakpoints.

Also use this parameter with Time Units (P606) to define the flowrate units. The limitation of four digits is for the LCD only, and the flowrate value is available with greater precision through communications.

## Example

Conditions	Enter
<ul style="list-style-type: none"> <li>Flowrate display: millions of gallons/day,</li> <li>Maximum flowrate is 376,500,000 gallons/day</li> </ul>	<ul style="list-style-type: none"> <li><b>376.5</b> for Maximum Flow (P604)</li> <li>and <b>4</b> for Time Units (P606).</li> </ul>

## P605 Zero Head [MR 200]

*The distance above Empty (P006) in Units (P005) representing zero head (and zero flow).*

Primary Index	Single Point Model	Dual Point Model
	Global	Transducer
Values	Range: -999 to 9999	
	Preset: 0.000	
Altered By	<ul style="list-style-type: none"> <li>P005 Units</li> <li>P007 Span</li> </ul>	
Related	<ul style="list-style-type: none"> <li>P006 Empty</li> <li>P801 Range Extension</li> <li>P926 Head Measurement</li> </ul>	

This feature can be used for most weirs and some flumes (e.g. Palmer Bowlus) where the zero reference is at a higher elevation than the channel bottom.

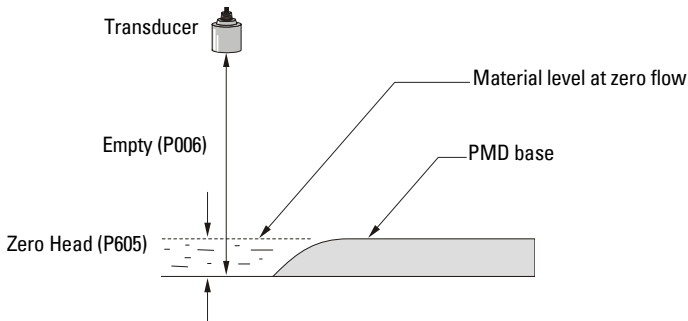

## P606 Time Units [MR 200]

*Determines the units used to display current flow and logging flow values.*

Primary Index	Single Point Model		Dual Point Model
	Global		Transducer
Values	1		seconds
	2		minutes
	3		hours
	4	*	days
Alters	•		
Altered By	• P608 Flowrate Units		

This is used when the Primary Measuring Device is **Ratiometric** (P608=0).

### Example

Conditions	Enter
<ul style="list-style-type: none"> <li>Flowrate display: millions of gallons/day,</li> <li>Maximum flowrate is 376,500,000 gallons/day</li> </ul>	<ul style="list-style-type: none"> <li><b>376.5</b> for Maximum Flow (P604)</li> <li>and <b>4</b> for Time Units (P606).</li> </ul>

## P607 Flowrate Decimal [MR 200]

*The maximum number of decimal places to be displayed.*

Primary Index	Single Point Model		Dual Point Model
	Global		Transducer
Values	0		no digits after the decimal point
	1		1 digit after the decimal point
	2		2 digits after the decimal point
	3		3 digits after the decimal point
Altered By	• P060 Decimal Position		

In RUN mode, the number of decimal places displayed is automatically adjusted (if necessary) to prevent the number of Flowrate digits from exceeding display capabilities.

The maximum number of head decimal places is controlled by Decimal Position (P060).

# P608 Flowrate Units [MR 200]

*The volume units used to display total flow.*

**Note:** Set this parameter only when using BS-3680/ISO 4359 Rectangular Flume or BS-3680/ISO 1438/1 Thin Plate V-Notch Weir (P600 = 6 or 7). Use the default value of 0 for P608 when P600 = 1 to 5.

Primary Index	Single Point Model		Dual Point Model	
	Global		Transducer	
Values	Ratiometric (P600=all)			
	0	*	Ratiometric calculation (units defined by P604)	
	Absolute (P600=6,7 only)			
	1		litres / second	
	2		cubic metres / hour	
	3		cubic metres / day	
	4		cubic feet / second	
	5		gallons / minute – Imperial	
	6		million gallons / day – Imperial	
Values	7		gallons / minute – U.S.	
	8		million gallons / day – U.S.	
Alters	<ul style="list-style-type: none"> <li>P606 Time Units</li> </ul>			
Altered By	<ul style="list-style-type: none"> <li>P600 Primary Measuring Device</li> </ul>			
Related	<ul style="list-style-type: none"> <li>P608 Flowrate Units</li> </ul>			

This parameter is enabled only if the primary measuring device (PMD) supports absolute calculations (P600=6,7). For absolute PMDs (P600=6,7) volume units can be specified using this parameter. If needed, absolute PMDs can still use ratiometric (P608=0) to accommodate other units.

## P610 Head Breakpoints [MR 200]

The head breakpoints for which flowrate is known. See “Accessing a Secondary Index” on page 117 for more information..

Primary Index	Single Point Model	Dual Point Model
	Global	Transducer
Secondary Index	Breakpoint	
Values	Range: 0.000 to 9999	
Related	<ul style="list-style-type: none"> <li>P611 Breakpoint Flowrates</li> </ul>	

The values in the Span for which flowrates are known. See *Universal Calculation Support* on page 83 for how to specify universal flows.

## P611 Breakpoint Flowrates [MR 200]

The flowrate corresponding to each Head Breakpoint entered.

Primary Index	Single Point Model	Dual Point Model
	Global	Transducer
Secondary Index	Breakpoint	
Values	Range: 0.000 to 9999	
Related	<ul style="list-style-type: none"> <li>P610 Head Breakpoints</li> </ul>	

These are the flowrates for the related breakpoints. See *Universal Calculation Support* on page 83 for how to specify universal flows.

### Head vs. Flowrate (P610 and P611)

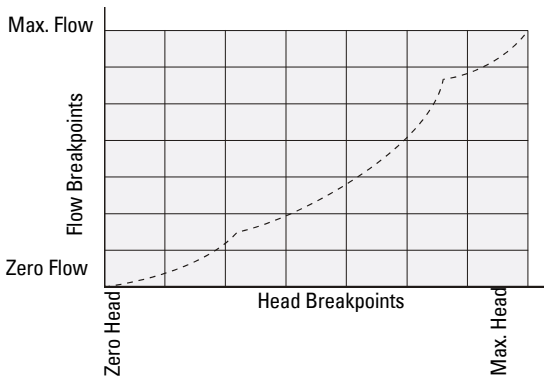

## P620 Low Flow Cutoff [MR 200]

*Eliminates totalizer activity for flows at or below the cutoff value.*

Primary Index	Single Point Model	Dual Point Model
	Global	Transducer
Values	Range: 0.000 to 9999	
	Preset = 5.000 %, or equivalent units	
Altered By	• P005 Units	
Related	• P007 Span	

Use this to enter the minimum head in units (P005) or as a percent of span.

## P621 Auto Zero Head [MR 200]

*Calibrates Zero Head (P605) based on actual head measurements.*

Primary Index	Single Point Model	Dual Point Model
	Global	Transducer
Values	Range: -999 to 9999	
Related	• P006 Empty • P062 Offset Reading • P605 Zero Head • P664 Temperature	

Use this parameter when the reported head is consistently high or low by a fixed amount.

**Before using this feature, verify the following parameters are correct:**

- Empty (P006)
- Temperature (P664)
- Offset Reading (P062=0)
- Zero Head Offset (P605)

### Procedure, with “head” steady

1. Press TRANSDUCER  to display the calculated head.
2. Repeat step ONE at least FIVE times to verify repeatability.
3. Measure the **actual** head (with a tape measure or solid rule).
4. Enter the **actual** head value.

The deviation between the entered Empty (P006) value and the calibrated Empty value is stored in Offset Correction (P652). Alternatively, the Empty parameter (P006) can be corrected directly.

# Pumped Volume Totalizer (P622) [MR 200]

The Pumped Volume Totalizer is a MultiRanger 200 feature only.

If the eight-digit totalizer display or a remote totalizer contact closure are desired, alter the following parameters.

## P622 Inflow / Discharge Adjust [MR 200]

*The method used to calculate the volume pumped, for **pumped total** Operation (P001 = 7).*

Primary Index	Single Point Model	Dual Point Model
	Global	Transducer
Values	1 = inflow * / pump cycle When the pump is off, the MultiRanger estimates the volume of inflow by recording the rate at which the liquid level changes. When the pump is operating, the estimated inflow volume is added to the pumped volume total. When the pump stops, the pumped volume of the previous pump cycle is added to the total volume pumped in the totalizer.	
	2 = inflow * ignored Inflow is assumed to be 0 while pumps are running.	
	3 = inflow * / rate (preset) Volume pumped is adjusted for inflow. Inflow rate is estimated by assuming that the rate calculated (P708) just prior to the start of the pump cycle remained constant during the pump cycle. Inflow rate is averaged using rate filter (P704), rate update time (P705) and rate update distance (P706) to control how the average rate is calculated.	
Related	<ul style="list-style-type: none"> <li>• P001 Operation</li> <li>• P704 Rate Filter</li> <li>• P705 Rate Update Time</li> <li>• P706 Rate Update Distance</li> <li>• P708 Volume Rate Display</li> </ul>	

\* or discharge



# Totalizer (P630 to P645) [MR 200]

The Totalizer features apply to MultiRanger 200 only.

## P630 LCD Totalized Multiplier [MR 200]

Use this feature if the LCD Total increments by too large (or too small) an amount.

Primary Index	Single Point Model		Dual Point Model
	Global		Transducer
Values	-3		.001
	-2		.01
	-1		.1
	0	*	1
	1		10
	2		100
	3		1000
Values	4		10,000
	5		100,000
	6		1,000,000
	7		10,000,000
Related	<ul style="list-style-type: none"> <li>LCD Totalizer (P322 and P323)</li> </ul>		

Enter the factor (powers of 10 only) by which actual volume is divided, prior to display on the LCD. Use a value such that the eight-digit totalizer doesn't roll over between readings.

### Example:

For an LCD Total display in 1000s of volume units, enter **3**.

## P633 LCD Totalized Decimal Position [MR 200]

Enter the maximum number of decimal places to be displayed.

Primary Index	Single Point Model		Dual Point Model
	Global		Transducer
Values	0		no digits after the decimal point
	1		1 digit after the decimal point
	2	*	2 digits after the decimal point
	3		3 digits after the decimal point
Related	<ul style="list-style-type: none"> <li>LCD Totalizer (P322 and P323)</li> </ul>		

**Note:** Set the decimal position during initial commissioning of the MultiRanger 200. If the position is changed later, the totalizer data in P322 and P323 will be incorrect and must be reset according to the new decimal value.

In RUN mode, the number of decimal places displayed is not automatically adjusted. When the LCD Total value is so large as to exceed display capabilities, the total **rolls over** to **0** and continues incrementing.

## P640 Remote Totalized Multiplier [MR 200]

Use this feature if the remote totalizer (device connected to the relay set for **totalizer operation** [relay Function, P111 = 40]), updates too slowly or rapidly.

Primary Index	Single Point Model		Dual Point Model
	Global		Transducer
Values	-3		.001
	-2		.01
	-1		.1
	0	*	1
Values	1		10
	2		100
	3		1000
	4		10,000
	5		100,000
	6		1,000,000
	7		10,000,000
Related	<ul style="list-style-type: none"> <li>P001 Operation</li> <li>P111 Relay Control Function</li> <li>P114 Relay <b>Duration</b> Setpoint</li> <li>P115 Relay <b>Interval</b> Setpoint</li> <li>P645 Relay Duration</li> </ul>		

Parameter is relevant only if Operation is set to OCM or Pumped Volume (P001 = 6 or 7). The relays on the MultiRanger have a maximum frequency of 2.5 Hz.

Enter the factor (powers of 10 only) by which actual volume is divided, prior to Remote Totalizer count increment.

**Example:**

For a Remote Totalizer update by 1000s of volume units, enter **3**.

## P641 Flow Sampler Mantissa [MR 200]

*Use this feature in conjunction with Flow Sampler Exponent (P642) to establish the number of flow units required to increment the Flow Sampler (device connected to the MultiRanger relay set for the flow sampler operation Relay Function, P111 = 41).*

Primary Index	Single Point Model	Dual Point Model
		Global
Values	Range: 0.001 to 9999	
	Preset = 1.000	
Related	<ul style="list-style-type: none"> <li>• P001 Operation</li> <li>• P111 Relay Control Function</li> <li>• OCM (P600 to P621)</li> <li>• P642 Flow Sampler Exponent</li> </ul>	

This parameter is relevant only if Operation is set to OCM (P001 = 6).

**Enter the mantissa (Y) for the exponent (Z) in the formula:**

Flow Sampler Increment =  $Y \times 10^Z$  Flow units.

**Example:** To count once every 4310 ( $4.31 \times 10^3$ ) flow units:

- set P641 to **4.31** and P642 to **3**

## P642 Flow Sampler Exponent [MR 200]

*Use this feature in conjunction with Flow Sampler Mantissa (P641) to establish the number of flow units required to increment the Flow Sampler (device connected to the MultiRanger relay set for the **flow sampler operation** Relay Function, P111 = 41).*

Primary Index	Single Point Model	Dual Point Model
		Global
Values	Range: -3 to +7 (integers only)	
	Preset = 0	
Related	<ul style="list-style-type: none"> <li>• P001 Operation</li> <li>• P111 Relay Control Function</li> <li>• OCM (P600 to P621)</li> <li>• P641 Flow Sampler Mantissa</li> </ul>	

This parameter is relevant only if Operation is set to OCM (P001 = 6).

**Enter the exponent (Z) for the mantissa (Y) in the formula:**

Flow Sampler Increment =  $Y \times 10^Z$  Flow units.

## P645 Relay Duration [MR 200]

*Use this feature (if desired) to adjust the minimum contact closure duration of a relay set as a totalizer, flow sampler, time (control), or aeration (P111 = 40, 41, 60 or 62)*

<b>Primary Index</b>	Global
<b>Values</b>	Range: 0.1 to 1024
	Preset = 0.2 (sec)
<b>Related</b>	<ul style="list-style-type: none"><li>P111 Relay Control Function</li></ul>

Enter minimum contact closure duration (in seconds) required by the device connected.

For the flow sampler function this value is used for both the ON time of the relay and the OFF time between contacts.

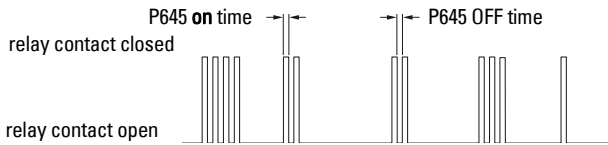

## Range Calibration (P650 to P654)

There are two types of calibration possible:

**Offset:** Adjusts the measurements by a fixed amount.

**Sound Velocity:** Adjusts speed of sound and changes the measurement calculations.

Do Offset calibration at any steady level unless a Sound Velocity calibration is also done. If both calibrations are done then do Offset at a known high level and Sound Velocity at a known low level.

# P650 Offset Calibration

Calibrates Empty (P006) if the reported level is consistently high or low by a fixed amount.

Primary Index	Single Point Model	Dual Point Model
	Global	Transducer
Values	Range: -999 to 9999	
Related	<ul style="list-style-type: none"><li>• P006 Empty</li><li>• P062 Offset Reading</li><li>• P605 Zero Head</li><li>• P652 Offset Correction</li><li>• P664 Temperature</li></ul>	

**Before using this feature, verify the following parameters are correct:**

- Empty (P006)
- Temperature (P664)
- Offset Reading (P062)
- Zero Head Offset (P605), if using OCM

## Offset Calibration

Begin with a steady level.

1. Press TRANSDUCER  to display the calculated reading.
2. Repeat Step One at least five times to verify repeatability.
3. Measure the actual reading (use tape measure).
4. Enter the actual value.

The deviation between the entered Empty (P006) value and the calibrated **Empty** value is stored in Offset Correction (P652).

# P651 Sound Velocity Calibration

Changes the speed of sound constant.

Primary Index	Single Point Model	Dual Point Model
	Global	Transducer
Values	Range: -999 to 9999	
Related	<ul style="list-style-type: none"><li>• P653 Velocity</li><li>• P654 Velocity at 20°C</li></ul>	

## Condition for use of this feature

- The acoustic beam atmosphere is other than air
- The acoustic beam atmosphere temperature is unknown
- The Reading accuracy is acceptable at higher material levels only

For best results, calibrate with the level at a known value near empty.

## Using Sound Velocity Calibration

Ensure a steady level at some low value (P653 and P654 adjusted accordingly)

1. Allow sufficient time for the vapor concentration to stabilize.
2. Press TRANSDUCER (↓) to display the calculated reading.
3. Repeat Step Two at least five times to verify repeatability.
4. Measure the actual reading (e.g. with a tape measure).
5. Enter the actual value.

Repeat this procedure if the atmosphere type, concentration, or temperature conditions are different from when the last sound velocity calibration was performed.

**Note:** In gasses other than air, the temperature variation may not correspond with the speed of sound variation. Turn off temperature sensor and use a fixed temperature.

## P652 Offset Correction

*The value altered when an Offset Calibration is performed.*

Primary Index	Single Point Model	Dual Point Model
	Global	Transducer
Values	Range: -999 to 999.0	
Related	• P650 Offset Calibration	

Alternatively, if the amount of Offset Correction required is known, enter the amount to be added to the Reading before display.

## P653 Velocity

*The value adjusted based on the Sound Velocity at 20 °C (P654) vs. Temperature (P664) characteristics of air.*

Primary Index	Single Point Model	Dual Point Model
	Global	Transducer
Values	Range: 50.3 to 20011.9 m/s (165 to 6601 ft/s)	
Related	• P651 Sound Velocity Calibration • P654 Velocity at 20°C	

Alternatively, enter the current sound velocity (if known), or perform a Sound Velocity Calibration (P651). The units used are m/s if P005 = 1, 2, or 3 (ft/s if P005 = 4 or 5).

# P654 Velocity at 20°C

*This value is used to automatically calculate Sound Velocity (P653).*

Primary Index	Single Point Model		Dual Point Model	
	Global		Transducer	
Values	Range: 50.0 to 2000.0 m/s (164 to 6562 ft/s)			
Related	<ul style="list-style-type: none"> <li>• P005 Units</li> <li>• P651 Sound Velocity Calibration</li> <li>• P653 Velocity</li> </ul>			

After performing a Sound Velocity Calibration, check this value to verify the acoustic beam atmosphere is **air** (344.1 m/s or 1129 ft/s).

Alternatively, if the acoustic beam atmosphere sound velocity at 20°C (68 °F) is known, and the sound velocity vs. temperature characteristics are similar to that of **air**, enter the sound velocity.

The units used are m/s if P005 = 1, 2, or 3 (or ft/s if P005 = 4 or 5).

## Temperature Compensation (P660 to P664)

### P660 Temp Source

*Source of the temperature reading used to adjust the speed of sound.*

Primary Index	Transducer		
Values	1	*	AUTO
	2		Temp Fixed
	3		Ultrasonic/Temperature Transducer
	4		TS-3 Temperature Sensor
	5		Average (TS-3 and transducer)
Alters	<ul style="list-style-type: none"> <li>• P664 Temperature</li> </ul>		
Related	<ul style="list-style-type: none"> <li>• P651 Sound Velocity</li> <li>• P653 Velocity</li> <li>• P654 Velocity at 20°C</li> <li>• P661 Temp Fixed</li> </ul>		

The MultiRanger uses the TS-3 temperature sensor assigned to the transducer. If one is not connected, the ultrasonic/temperature transducer is used. If the transducer does not have an internal temperature sensor, the Temp Fixed (P661) value is used.

If the acoustic beam atmosphere temperature varies with distance from the transducer, connect a TS-3 Temperature Sensor and ultrasonic / temperature transducers, and select **average**.

In gasses other than air, the temperature variation may not correspond with the speed of sound variation. In these cases turn off the temperature sensor and use a fixed temperature.

## P661 Temp Fixed

*Use this feature if a temperature sensing device is not used.*

<b>Primary Index</b>	Transducer
<b>Values</b>	Range: -199 to 199 (preset = 20 °C)
<b>Related</b>	<ul style="list-style-type: none"> <li>• P651 Sound Velocity Calibration</li> <li>• P653 Velocity</li> <li>• P654 Velocity at 20°C</li> <li>• P660 Temp Source</li> </ul>

Enter the temperature (in °C) of the atmosphere within the transducer acoustic beam. If the temperature varies with distance from the transducer, enter the average temperature.

## P663 Temperature Transducer Allocation

*This feature may only be used for **differential** or **average** Operation (P001 = 4 or 5).*

<b>Primary Index</b>	Transducer		
<b>Values</b>	1	*	Transducer One
	2		Transducer Two
	1:2		Transducer One and Two average [MR200]
<b>Related</b>	<ul style="list-style-type: none"> <li>• P651 Sound Velocity Calibration</li> <li>• P653 Velocity</li> <li>• P654 Velocity at 20°C</li> </ul>		

As preset, the temperature measurements of Ultrasonic / Temperature Transducer One and Two are allocated to Points 1 and 2 respectively.

Use this feature if the temperature measurement from both transducers should be identical, but one is located close to a radiant heat source. Allocate the temperature measurement of the other transducer to both transducer Point Numbers.

Enter the number of the Transducer whose temperature measurement will be used for the distance calculation of the Point Number displayed. When both transducers are allocated to a Point Number, the temperature measurements from each are averaged.



# P664 Temperature

View the transducer temperature in °C.

<b>Primary Index</b>	Transducer
<b>Values</b>	Range: -50 to 150 (view only)
<b>Altered By</b>	<ul style="list-style-type: none"> <li>P660 Temp Source</li> </ul>
<b>Related</b>	<ul style="list-style-type: none"> <li>P651 Sound Velocity Calibration</li> <li>P653 Velocity</li> <li>P654 Velocity at 20°C</li> <li>P661 Temp Fixed</li> </ul>

Value is displayed when **6.1** is pressed in RUN mode (see *Readings in Run Mode* on page 23).

If Temp Source (P660) is set to any value other than Fixed Temp, the value displayed is the temperature measured. If Temp Source is set to Fixed Temp, the P661 value is displayed.

## Rate (P700 to P708)

These parameters determine how material level changes are reported.

### P700 Max Fill Rate

*Adjusts the MultiRanger response to increases in the actual material level (or advance to a higher Failsafe Material Level, P071).*

Primary Index	Single Point Model	Dual Point Model
	Global	Transducer
<b>Values</b>	Range: 0.000 to 99.00 m (or equivalent depending on units)	
<b>Altered by</b>	<ul style="list-style-type: none"> <li>P003 Maximum Process Speed</li> </ul>	
<b>Related</b>	<ul style="list-style-type: none"> <li>P005 Units</li> <li>P007 Span</li> <li>P071 Failsafe Material Level</li> </ul>	

Enter a value slightly greater than the maximum vessel filling rate. This value, in Units (P005) or % of Span (P007) per minute, is automatically altered when Maximum Process Speed (P003) is altered.

P003 Value	Meters/Minute
1	0.1
2	1
3	10

# P701 Max Empty Rate

*Adjusts the MultiRanger response to decreases in the actual material level (or advance to a lower Failsafe Material Level), P071).*

Primary Index	Single Point Model		Dual Point Model	
	Global		Transducer	
Values	Range: 0.000 to 99.00 m (or equivalent depending on units)			
Altered by	<ul style="list-style-type: none"> <li>P003 Maximum Process Speed</li> </ul>			
Related	<ul style="list-style-type: none"> <li>P005 Units</li> <li>P007 Span</li> <li>P071 Failsafe Material Level</li> </ul>			

Enter a value slightly greater than the maximum vessel emptying rate. This value, in Units (P005) or % of Span (P007) per minute, is automatically altered when Maximum Process Speed (P003) is altered.

P003 Value	Meters / Minute
1	0.1
2	1
3	10

# P702 Filling Indicator

*The fill rate required to activate the LCD Filling indicator (↑).*

Primary Index	Single Point Model		Dual Point Model	
	Global		Transducer	
Values	Range: 0.000 to 99.00 m (or equivalent depending on units)			
Altered by	<ul style="list-style-type: none"> <li>P003 Maximum Process Speed</li> </ul>			
Related	<ul style="list-style-type: none"> <li>P005 Units</li> <li>P007 Span</li> <li>P700 Max Fill Rate</li> </ul>			

This value (in Units (P005) or % of Span (P007) per minute) is automatically set to 1/10 of the Max Fill Rate (P700).

# P703 Emptying Indicator

The empty rate required to activate the LCD Emptying indicator (↕).

Primary Index	Single Point Model	Dual Point Model
		Global
Values	Range: 0.000 to 99.00 m (or equivalent depending on units)	
Altered by	<ul style="list-style-type: none"> <li>P003 Maximum Process Speed</li> </ul>	
Related	<ul style="list-style-type: none"> <li>P005 Units</li> <li>P007 Span</li> <li>P701 Max Empty Rate</li> </ul>	

This value (in Units (P005) or % of Span (P007) per minute) is automatically set to 1/10 of the Max Empty Rate (P701).

# P704 Rate Filter

Damps Rate Value (P707) fluctuations.

Primary Index	Single Point Model	Dual Point Model
		Global
Values	0	Rate display not required
		Filtered Output
	1	Continuously filtered and updated
		Interval Output
	2	1 minute or 50 mm (2 in)
	3	5 minutes or 100 mm (3.9 in)
	4	10 minutes or 300 mm (11.8 in)
	5	10 minutes or 1000 mm (39.4 in)
Alters	<ul style="list-style-type: none"> <li>P707 Rate Value</li> </ul>	
Altered by	<ul style="list-style-type: none"> <li>P003 Maximum Process Speed</li> </ul>	
Related	<ul style="list-style-type: none"> <li>P705 Rate Update Time/ P706 Rate Update Distance</li> </ul>	

Enter the time or distance interval over which the Rate Value is to be calculated before the display updates.

This is automatically altered along with Maximum Process Speed (P003).

This value automatically alters the Rate Update Time (P705) and / or Rate Update Distance (P706). Alternatively, these parameter values may be altered independently.

## P705 Rate Update Time

The time period (in seconds) over which the material level rate of change is averaged before Rate Value update.

Primary Index	Single Point Model	Dual Point Model
	Global	Transducer
Values	Range: 0.000 to 9999	
Related	<ul style="list-style-type: none"><li>P707 Rate Value</li></ul>	

## P706 Rate Update Distance

The material level change (in metres) to initiate a Rate Value update.

Primary Index	Single Point Model	Dual Point Model
	Global	Transducer
Values	Range: 0.000 to 9999	
Related	<ul style="list-style-type: none"><li>P707 Rate Value</li></ul>	

## P707 Rate Value

The rate of material level change (in Units (P005) or % of Span (P007) per minute).

Primary Index	Single Point Model	Dual Point Model
	Global	Transducer
Values	Range: -999 to 9999 (view only)	
Altered By	<ul style="list-style-type: none"><li>P704 Rate Filter</li></ul>	
Related	<ul style="list-style-type: none"><li>P005 Units</li><li>P007 Span</li></ul>	

A negative rate indicates the vessel is emptying.

This is the value displayed when  is pressed in the RUN mode as described in the *Readings in RUN Mode* chart on page 23.

## P708 Volume Rate Display [MR 200]

The rate of change of volume in **percent of maximum volume** per minute.

Please note that this feature applies to the MultiRanger 200 only.

Primary Index	Single Point Model	Dual Point Model
	Global	Transducer
Values	Range: -999 to 9999 (view only)	
Related	<ul style="list-style-type: none"><li>P622 Inflow / Discharge Adjust</li></ul>	

This value is used internally to calculate inflow in pumped volume applications (P622=3).

Press READING  to toggle between percent and volume.

## Measurement Verification (P710 to P713)

### P710 Fuzz Filter

Use this to stabilize the reported level, due to level fluctuations (such as a rippling or splashing liquid surface) within the Echo Lock Window (P713).

Primary Index	Single Point Model	Dual Point Model
	Global	Transducer
Values	Range: 0 to 100 (0 = off)	
Altered by	<ul style="list-style-type: none"><li>P003 Maximum Process Speed</li></ul>	
Related	<ul style="list-style-type: none"><li>P007 Span</li><li>P713 Echo Lock Window</li></ul>	

This value (in % of Span, P007) is automatically altered when Maximum Process Speed (P003) is altered. The higher the value entered, the greater the fluctuation stabilized.

# P711 Echo Lock

Use this feature to select the measurement verification process.

Primary Index	Single Point Model		Dual Point Model
	Global		Transducer
Values	0		Off
	1		Maximum verification
	2	*	Material agitator
	3		Total lock
Related	<ul style="list-style-type: none"> <li>• P700 Max Fill Rate</li> <li>• P701 Max Empty Rate</li> <li>• P712 Echo Lock Sampling</li> <li>• P713 Echo Lock Window</li> <li>• P820 Algorithm</li> </ul>		

If a material agitator (mixer) is used in the vessel monitored, set Echo Lock for **maximum verification** or **material agitator** to avoid agitator blade detection. Ensure the agitator is always ON while the MultiRanger is monitoring the vessel to avoid stationary blade detection.

When set for **max verification** or **material agitator**, a new measurement outside of the Echo Lock Window (P713) must meet the sampling criterion (P712).

For **total lock**, Echo Lock Window (P713) is preset to zero **0**. The MultiRanger continuously searches for the best echo according to the algorithm chosen (P820). If the selected echo is within the window, the window is then centered about the echo. If not, the window widens with each successive shot until the selected echo is within the window. The window then returns to its normal width.

When Echo Lock is OFF, the MultiRanger responds immediately to a new measurement as restricted by the Max Fill / Empty Rate (P700 / P701); however, measurement reliability is affected.

# P712 Echo Lock Sampling

The sampling criterion sets the number of consecutive echoes appearing above or below the echo currently locked onto, that must occur before the measurements are validated as the new reading (for Echo Lock P711 values: 1 or 2).

Primary Index	Single Point Model	Dual Point Model
		Global
Values	Range: 1:1 to 50:50	
	Format: x:y	
	x = the number of <b>above</b> echoes	
	y = the number of <b>below</b> echoes	
Related	<ul style="list-style-type: none"> <li>P711 Echo Lock</li> </ul>	

P711 value	P712 preset value
1, max verification	5:5
2, material agitator	5:2

## Example:

### Setting

- P711 = 2, material agitator
- P712 = 5:2

### Result

- a new reading will not be validated unless five consecutive measurements higher or two consecutive measurements lower than the current reading occur
- Resetting P711 returns P712 to the respective preset values

# P713 Echo Lock Window

Adjusts the size of the Echo Lock Window.

Primary Index	Single Point Model	Dual Point Model
		Global
Values	Range: 0.000 to 99.00 m (or equivalent depending on units), nearest acceptable value is returned	
	Preset: 0.000	
Altered by	<ul style="list-style-type: none"> <li>P003 Maximum Process Speed</li> </ul>	
Related	<ul style="list-style-type: none"> <li>P005 Units</li> <li>P711 Echo Lock</li> </ul>	

The Echo Lock Window is a **distance window** (units P005) centred on the echo and used to derive the Reading. When a new measurement is in the window, it is re-centred and the new Reading calculated. Otherwise, the new measurement is verified by Echo Lock (P711) before the reading is updated.

When **0** is entered the window is automatically calculated after each measurement. For slower P003 Maximum Process Speed values the window is narrow, for faster P003 values the window becomes wider.

## Transducer Scanning (P726 to P729)

### P726 Level System Sync

*Enables the System Sync on the terminal block.*

<b>Primary Index</b>	Global		
<b>Values</b>	0		not required
	1	*	synchronize level monitors

Use this if another level measurement system is mounted nearby, and they are wired together on the Sync terminal.

### P727 Scan Delay

*The delay, in seconds, between measurements from transducer points (dual point model only).*

<b>Primary Index</b>	Global		
<b>Values</b>	Range: 0 to 60 seconds		
	Preset: 5.0		
<b>Altered by</b>	<ul style="list-style-type: none"> <li>P003 Maximum Process Speed</li> </ul>		
<b>Related</b>	<ul style="list-style-type: none"> <li>P001 Operation</li> </ul>		

This feature may only be used to adjust the delay before the next point is scanned. Enter the amount of delay in seconds. This value is automatically altered when Maximum Process Speed (P003) is altered.



# P728 Shot Delay

*The delay, in seconds, between transducer shots.*

<b>Primary Index</b>	Transducer
<b>Values</b>	Range: 0.1 to 4.0
	Preset: 0.5

Use this if transient acoustic noise within the vessel is causing measurement difficulties due to echoes from one shot being received on the next. If more than one ultrasonic unit is installed for redundancy, this value should be 0.

# P729 Scan Time

*View the elapsed time (in seconds) since the point displayed was last scanned.*

<b>Primary Index</b>	Level
<b>Values</b>	Range: 0.000 to 9999 (view only)
<b>Related</b>	<ul style="list-style-type: none"><li>• P001 Operation</li></ul>

This may be viewed as an Auxiliary Reading in the RUN mode.

# Display (P730 to P739)





## P730 Auxiliary Reading

*Use this feature to display operator selected Auxiliary Readings temporarily or indefinitely (as desired).*

<b>Primary Index</b>	Global
<b>Values</b>	Range: 000 to 999
	Display: OFF, HOLd

Select **OFF** to display Auxiliary Readings temporarily. Select **HOLd** to display Auxiliary Readings until another Auxiliary Reading is selected or programming mode is entered. See the *Hand Programmer* section on page 27 for RUN mode auxiliary readings.

### Selecting the Auxiliary Reading operation

1. Press READING  to display the Auxiliary Function symbol.
2. Press ARROWS   to access the OFF or HOLd option desired.
3. Press ENTER 

If necessary, enter the Parameter Number to default in the Auxiliary Reading display. That value will show in the auxiliary reading area by default. Other values are available but will reset to the parameter defined here.

## P731 Auxiliary Reading Key

Enter the Parameter Number whose value is to be displayed in the Auxiliary Reading field

<b>Primary Index</b>	Global
<b>Values</b>	Range: 000 to 999
	Preset: Material Reading, P921

 is pressed in the RUN mode. See the *Hand Programmer* section on page 27 for RUN mode auxiliary readings.

## P732 Display Delay

Adjusts the Point Number display scroll speed.



<b>Primary Index</b>	Global
<b>Values</b>	Range: 0.5 to 10
	Preset: 1.5 seconds
<b>Related</b>	<ul style="list-style-type: none"> <li>P001 Operation</li> <li>P737 Primary Reading</li> </ul>

Use this feature to adjust the delay before the display advances to the next Point Number. Display scrolling is independent from transducer scanning.

## P733 Scroll Access

Use this feature to select the parameter scroll access option desired.

<b>Primary Index</b>	Global		
<b>Values</b>	0	Off	to scroll to all parameters (P001 to P999)
	1	*	Smart for Quick Start, altered, and tagged parameters
	2	Tagged	to scroll to operator tagged parameters only

Press READING  and  to tag / untag any accessed parameter.  is displayed to indicate the parameter accessed is tagged.

**Note:** Quick Start parameters (P001 – P007) and those changed from factory default settings cannot be untagged.

# P735 Backlight

*Controls the LCD backlighting.*

<b>Primary Index</b>	Global		
<b>Values</b>	0		Off
	1	*	On
	2		Keypad activated

The backlight can be forced on or off, or be controlled by a programmer, in which case it will turn OFF 30 seconds after the last key is pressed.

# P737 Primary Reading [MR 200]

*The reading shown on the primary reading display when in RUN mode.*

<b>Primary Index</b>	Global		
<b>Values</b>	Range: 0 to 3		
	1	*	Default reading (P920) based on operation (P001)
	2		LCD totalizer (P322, P323)
	3		Automatically toggle between 1 and 2
<b>Related</b>	<ul style="list-style-type: none"><li>• LCD Totalizer (P322 and P323)</li><li>• P732 Display Delay</li><li>• P920 Reading Measurement</li></ul>		

When this value indicates TOGGLE, then both readings (default and totalizer) are shown in the time specified in display delay (P732).

# P741 Communications Timeout

*The maximum time allowed between receiving a request and transmitting the response.*

<b>Primary Index</b>	Port	
<b>Values</b>	Range: 0 to 60 000 milliseconds	
	Preset: 5 000 ms	

If the maximum time is exceeded, no response will be transmitted, and the action required may not be completed.

# SmartLinX Reserved (P750 to P769)

These parameters are reserved for optional SmartLinX communications cards and vary by card. Refer to the SmartLinX documentation to determine if any of them are used.

## Communications (P770 to P782)

The MultiRanger communication ports are configured by a series of parameters that are indexed by port. See the *Communications* section on page 89 for a complete description of communications set-up.

Communication parameters are indexed to these communication ports, unless otherwise noted:

Port	Description
1	RS-232 port (RJ-11 modular telephone)
2	RS 485 port on terminal block

### P770 Port Protocol

*The communications protocol used between the MultiRanger and other devices.*

Primary Index	Communications Port	
Values	0	Communications port disabled
	1	Siemens Milltronics Dolphin protocol
	2	Modbus ASCII slave serial protocol
	3	* Modbus RTU slave serial protocol (preset for ports 1 and 2)

The MultiRanger supports the internationally recognized Modbus standard in both ASCII and RTU formats. Other protocols are available with optional SmartLinX cards.

### P771 Network Address

*The unique identifier of the MultiRanger on the network.*

Primary Index	Communications Port	
Values	Range: 0 to 9999	
	1	* Preset:

For devices connected with the Siemens Milltronics protocol this parameter is ignored. For devices connected with a serial Modbus slave protocol, this parameter is a number from 1-247. The network administrator must ensure that all devices on the network have unique addresses. Do not use the value **0** for Modbus communications as this is the broadcast address and is inappropriate for a slave device.

## P772 Baud Rate

*The communication rate with the master device.*

Primary Index	Communications Port		
Values	4.8		4800 baud
	9.6		9600 baud
	19.2	*	19,200 baud (preset for port 2)
	115.2	*	115,200 baud (preset for port 1)

This specifies the rate of communication in Kbaud. Any value may be entered but only the values shown above are supported. The baud rate should reflect the speed of the connected hardware and protocol used.

## P773 Parity

*The serial port parity.*

Primary Index	Communications Port		
Values	0	*	No Parity
	1		Odd Parity
	2		Even Parity

Ensure that the communications parameters are identical between the MultiRanger and all connected devices. For example, many modems default to N-8-1 which is No parity, 8 data bits, and 1 stop bit.

## P774 Data Bits

*The number of data bits per character.*

Primary Index	Communications Port		
Values	Range: 5 to 8		
	8	*	Modbus RTU
	7 or 8		Modbus ASCII
	7 or 8		Dolphin Plus

## P775 Stop Bits

*The number of bits between the data bits.*

<b>Primary Index</b>	Communications Port		
<b>Values</b>	Range: 1 or 2		
	1	*	Preset:

## P778 Modem Available

*Sets the MultiRanger to use an external modem..*

<b>Primary Index</b>	Communications Port		
<b>Values</b>	0	*	No modem connected
	1		Answer only

## P779 Modem Inactivity Timeout

*Sets the time that the unit will keep the modem connected with no activity.*

<b>Primary Index</b>	Communications Port		
<b>Values</b>	Range: 0-9999 seconds		
	0	*	No timeout
<b>Related</b>	<ul style="list-style-type: none"><li>• P778 Modem Available</li><li>• P779 Modem Inactivity Timeout</li></ul>		

To use this parameter, ensure that P778 (Modem Available) = 1. Ensure that the value is low enough to avoid unnecessary delays when an unexpected disconnect occurs but long enough to avoid timeout while you are still legitimately connected. This parameter value is ignored by the Modbus Master Drivers, as they automatically disconnect when done.

### Hanging Up

If the line is idle and the P779 Modem Inactivity Timeout expires, then the modem is directed to hang up the line. Ensure that P779 is set longer than the standard polling time of the connected master device. **0** disables the inactivity timer.

# P782 Parameter Index Location

*Determines where index information is stored for the parameter access area.*

<b>Primary Index</b>	Global		
<b>Values</b>	0	*	Global
	1		Parameter-Specific
<b>Altered By</b>	• P770 Port Protocol		

## Global (0)

The primary and secondary index values are global (they affect all of the parameter access area at once) and stored in:

- primary index – R43,999
- secondary index – R43,998

## Parameter-Specific (1)

The primary and secondary index values are encoded into the format words found between R46,000 and R46,999. Each format work corresponds with the R44,000 series number in the parameter access map. For example, the format register R46,111 corresponds to the parameter P111 and the value is stored in R44,111. If the Modbus protocol (P770 = 2 or 3) is not used this parameter is ignored.

# SmartLinx Hardware Testing (P790 to P795)

**Note:** These parameters are used to test and debug a SmartLinx card (if installed). Disregard these parameters if you do not have a SmartLinx card installed.

## P790 Hardware Error

*The results of ongoing hardware tests in the communications circuitry.*

<b>Primary Index</b>	Global		
<b>Values</b>	PASS	*	No errors
	FAIL		Error occurred communicating with card; communications should resume.
	ERR1		No module installed, or module not supported; SmartLinx communications have been disabled
<b>Related</b>	• P791 Hardware Error Code • P792 Hardware Error Count		

If FAIL or ERR1 is displayed in P790 (Hardware Error), go to P791 (Hardware Error Code) and P792 (Hardware Error Count) for information about the error.

## P791 Hardware Error Code

Indicates the precise cause of **Fail** or **ERR1** condition from P790.

<b>Primary Index</b>	Global		
<b>Values</b>	0	*	No error
	8		No SmartLinX card installed
	Any other value		Error code; provide this code to your Siemens Milltronics representative for troubleshooting
<b>Related</b>	• P790 Hardware Error		

## P792 Hardware Error Count

A count that increments by **1** each time **Fail** is reported in P790 (Hardware Error).

<b>Primary Index</b>	Global		
<b>Values</b>	Range: 0 to 9999		
	Error count; provide this number to your Siemens Milltronics representative for troubleshooting.		
<b>Related</b>	• P790 Hardware Error		

## P794 SmartLinX Module Type

*This parameter is used to identify the module type when SmartLinX is used. If you are not using SmartLinX, this parameter is not functional. Please see the associated SmartLinX instruction manual for a full description of this parameter.*

## P795 SmartLinX Protocol

*This parameter is used to identify the protocol when SmartLinX is used. If you are not using SmartLinX, this parameter is not functional. Please see the associated SmartLinX instruction manual for a full description of this parameter.*



# P799 Communications Control

*Enables the read/write access to parameters via remote communications.*

<b>Primary Index</b>	Protocol (Index 1 controls the Modbus Master (RS-485 or RS-232); Index 2 controls the Fieldbus Master (PROFIBUS DP, DeviceNet, or Allen Bradley Remote I/O))		
<b>Values</b>	0		Read Only
	1	*	Read/Write
	2		Restricted Access – read only except for P799 which is read/write

### Notes:

- P799 controls the lock access via communications.
- P000 controls the lock access via the Siemens handheld programmer.

## Echo Processing (P800 to P807)

### P800 Near Blanking

*The space near the transducer face which cannot be measured.*

<b>Primary Index</b>	<b>Single Point Model</b>		<b>Dual Point Model</b>
	Global		Transducer
<b>Values</b>	Range: 0.000 to 99.00 m (or equivalent depending on units)		
	Preset:	0.300m (Most transducers)	
		0.450m (XCT-8, XCT-12)	
<b>Related</b>	<ul style="list-style-type: none"> <li>• P006 Empty</li> <li>• P007 Span</li> <li>• P833 TVT Start Min</li> </ul>		

Use this feature if the surface is reported to be near the transducer face but is in fact much further away. Extend this value when changing transducer location, mounting, or aiming.

Please note that changing the Near Blanking cannot correct measurement problems. Ensure that Span (P007) < Empty (P006) minus Near Blanking (P800)

# P801 Range Extension

*Allows the material level to fall below the Empty setting without reporting LOE.*

Primary Index	Single Point Model		Dual Point Model
		Global	
Values	Range: 0.000 to 99.00 m, or max. span (P007), or equivalent depending on units		
	Preset: 20% of Span (P007)		
Related	<ul style="list-style-type: none"> <li>• P005 Units</li> <li>• P006 Empty</li> <li>• P007 Span</li> <li>• P004 Transducer</li> </ul>		

This feature is useful in OCM applications where the Empty level is set to the bottom of the weir, and above the bottom of the channel, and should be used if the surface monitored can fall past the Empty (P006) level in normal operation. The value is added to Empty (P006) and can be greater than the range of the transducer. If the surface monitored can extend beyond Empty (P006), increase Range Extension (in Units (P005) or % of Span) such that Empty plus Range Extension is greater than the transducer face to furthest surface to be monitored distance. This is often the case with OCM when using weirs and some flumes.

# P802 Transducer with Submergence Shield

*Used when the transducer is expected to be submerged on occasion.*

Primary Index	Single Point Model			Dual Point Model
		Global		
Values	0	*	Off	
	1		Submergence transducer	
Related	<ul style="list-style-type: none"> <li>• P006 Empty</li> <li>• P071 Failsafe Material Level</li> <li>• Relays</li> </ul>			

When a transducer with a submergence shield is submerged, the shield traps an air pocket that creates a special echo. The MultiRanger recognizes the echo and advances the reading to the highest level and operates displays and outputs accordingly. This feature is effective for when power is returned while the transducer is submerged.

# P803 Shot / Pulse Mode

*Determines what type of ultrasonic shots are fired.*

Primary Index	Single Point Model		Dual Point Model
	Global		Transducer
Values	1		Short
	2	*	Short and long
Related	<ul style="list-style-type: none"> <li>• P006 Empty</li> <li>• P805 Echo Confidence</li> <li>• P804 Confidence Threshold</li> <li>• P852 Short Shot Range</li> </ul>		

Increases MultiRanger response when the monitored surface is close to the transducer face. Select **short and long** to have short and long acoustic shots fired for each measurement, regardless of the transducer to surface distance. Select **short** to have only short shots fired if the Echo Confidence (P805) produced by a short shot exceeds the short Confidence Threshold (P804) and the monitored surface is always within the Short Shot Range (P852).

# P804 Confidence Threshold

*Determines which echoes are evaluated by software.*

Primary Index	Single Point Model		Dual Point Model
	Global		Transducer
Values	Range: 0 to 99:0 to 99		
	Preset: 10:5		
Related	<ul style="list-style-type: none"> <li>• P805 Echo Confidence</li> </ul>		

The short and long shot Confidence Thresholds are preset to 10 and 5 respectively. When Echo Confidence (P805) exceeds the Confidence Threshold, the echo is evaluated by Sonic Intelligence®. Values are entered as two numbers separated by a decimal point. The first number is the short shot confidence and the second number is the long shot confidence.

**Note:** The decimal point is replaced with a colon (:) on the display.

## P805 Echo Confidence

*Displays the echo confidence of the measurement echo from the last shot.*

<b>Primary Index</b>	Transducer
<b>Values</b>	Format: x:y (view only)
	x = short (0 to 99)
	y = long (0 to 99)
<b>Related</b>	<ul style="list-style-type: none"> <li>P804 Confidence Threshold</li> <li>P830 TVT Type</li> </ul>

Use this feature to monitor the effect of transducer aiming, location, and mechanical transducer / mounting isolation.

Both short and long shot Echo Confidence is displayed. (To display this value in the auxiliary display while the unit is running, press  for 4 seconds.)

Display	Description
<b>x:--</b>	short shot confidence value, (long shot not used).
<b>--:y</b>	long shot confidence value, (short shot not used).
<b>xy</b>	short and long shot confidence values (both used).
<b>E</b>	transducer cable is open or short circuited.
<b>--:--</b>	no shots were processed for Sonic Intelligence <sup>®</sup> evaluation.

## P806 Echo Strength

*Displays the strength (in dB above 1  $\mu$ V RMS) of the echo which was selected as the measurement echo.*

<b>Primary Index</b>	Transducer
<b>Values</b>	Format: 0 to 99 (view only)

## P807 Noise

*Displays the average and peak ambient noise (in dB above 1  $\mu$ V RMS) being processed.*

<b>Primary Index</b>	Transducer
<b>Values</b>	Format: x:y (view only)
	x = average (-99 to 99)
	y = peak (-99 to 99)

The noise level is a combination of transient acoustic noise and electrical noise (induced into the transducer cable or receiving circuitry). See *Noise Problems* in the *Troubleshooting* Section on page 232.

# Advanced Echo Processing (P815 to P825)

The following parameters are for authorized Siemens Milltronics Service personnel or technicians familiar with Siemens Milltronics echo processing techniques.

## P815 Echo Time Filtered

*The time (in ms) from the transmission of the pulse, to when it is processed.*

<b>Primary Index</b>	Transducer
<b>Values</b>	Range: 0.0 to 9999 (view only)
<b>Related</b>	<ul style="list-style-type: none"><li>• P816 Echo Time Raw</li></ul>

## P816 Echo Time Raw

*The time (in ms) from the transmit pulse to the processed echo.*





<b>Primary Index</b>	Transducer
<b>Values</b>	Range: 0.0 to 9999 (view only)
<b>Related</b>	<ul style="list-style-type: none"><li>• P815 Echo Time Filtered</li></ul>

# P820 Algorithm

*Chooses the algorithm to generate the measured value from the profile.*

Primary Index	Single Point Model		Dual Point Model
	Global		Transducer
Values	1		ALF = flat Area, Largest, and First average
	2		A = flat Area only
	3		L = flat Largest only
	4		F = flat First only
	5		AL = flat Area and Largest average
	6		AF = flat Area and First average
	7		LF = flat Largest and First average
	8	*	bLF = smooth Largest or First
	9		bL = smooth Largest only
	10		bF = smooth First only
	12		tF = true First only
Related	<ul style="list-style-type: none"> <li>• P805 Echo Confidence</li> <li>• P821 Spike Filter</li> <li>• P822 Narrow Echo Filter</li> <li>• P823 Reform Echo</li> <li>• P825 Echo Marker Trigger</li> </ul>		

Use this to select the algorithm(s) the Sonic Intelligence® echo selection is based on. Use P805 Echo Confidence (page 202) to determine which algorithm gives the highest confidence under all level conditions. If the wrong echo is processed, observe the echo processing displays and select an alternate algorithm, either by entering the numeric value desired, or as below:

1. Press MEASURE  to display the Auxiliary Function symbol.
2. Press ARROWS   to access the desired Reading display symbols.
3. Press ENTER  when the required algorithm is displayed.

# P821 Spike Filter

*Dampens spikes in the echo profile to reduce false readings.*

Primary Index	Single Point Model		Dual Point Model
	Global		Transducer
Values	0		Off
	1	*	On
Related	<ul style="list-style-type: none"> <li>• P820 Algorithm</li> <li>• P822 Narrow Echo Filter</li> <li>• P823 Reform Echo</li> <li>• P825 Echo Marker Trigger</li> </ul>		

Use P821 if interference spikes are on the long shot Echo Profile display.

# P822 Narrow Echo Filter

*Filters out echoes of a specific width.*

Primary Index	Single Point Model		Dual Point Model
	Global		Transducer
Values	0 = OFF (preset), nearest acceptable value returned		
	greater = wider		
Related	<ul style="list-style-type: none"> <li>• P820 Algorithm</li> <li>• P821 Spike Filter</li> <li>• P823 Reform Echo</li> <li>• P825 Echo Marker Trigger</li> </ul>		

Use this for transducer acoustic beam interference (e.g. ladder rungs). Enter the width of false echoes (in ms) to be removed from the long shot Echo Profile. When a value is keyed in, the nearest acceptable value is entered.

## P823 Reform Echo

*Smooths jagged peaks in the echo profile.*

Primary Index	Single Point Model	Dual Point Model
		Global
Values	0 = OFF (preset)	
	greater = wider, nearest acceptable value returned	
Related	<ul style="list-style-type: none"> <li>• P002 Material</li> <li>• P820 Algorithm</li> <li>• P821 Spike Filter</li> <li>• P822 Narrow Echo Filter</li> <li>• P825 Echo Marker Trigger</li> </ul>	

Use this feature, when monitoring solids (P002 = 2), if the reported level fluctuates slightly, though the monitored surface is still. Enter the amount (in ms) of long shot Echo Profile smoothing required. When a value is keyed in, the nearest acceptable value is entered.

## P825 Echo Marker Trigger

*The point on the primary echo on which the measured value is based.*

Primary Index	Single Point Model	Dual Point Model
		Global
Values	Range: 5 to 95%	
	Preset: 50%	
Related	<ul style="list-style-type: none"> <li>• P820 Algorithm</li> <li>• P821 Spike Filter</li> <li>• P822 Narrow Echo Filter</li> <li>• P823 Reform Echo</li> </ul>	

Use this feature if the reported material level fluctuates slightly, due to a variable rise in the leading edge of the true echo on the Echo Profile.

Enter the value (in percent of echo height) to ensure the Echo Lock Window intersects the Echo Profile at the sharpest rising portion of the Echo Profile representing the true echo. This value is preset to 50%.



# Advanced TVT Adjustment (P830 to P835)

The following parameters are for authorized Siemens Milltronics Service personnel or technicians familiar with Siemens Milltronics echo processing techniques.

Advanced TVT control applies to long shots only.

## P830 TVT Type

*Selects the TVT Curve used.*

Primary Index	Single Point Model			Dual Point Model
	Global			Transducer
Values	1	*	TVT Short Curved	
	2		TVT Short Flat	
	3		TVT Long Flat	
	4		TVT Long Smooth Front	
	5		TVT Long Smooth	
	6		TVT Slopes	
Altered By	<ul style="list-style-type: none"> <li>P002 Material</li> </ul>			
Related	<ul style="list-style-type: none"> <li>P805 Echo Confidence</li> <li>P835 TVT Slope Min</li> </ul>			

Select the TVT type which gives the highest confidence (P805) under all level conditions. Use this parameter with caution, and do not use TVT **Slopes** with the **bF** or **bLF** Algorithm (P820).

## P831 TVT Shaper

*Turns the TVT Shaper ON or OFF.*

Primary Index	Single Point Model			Dual Point Model
	Global			Transducer
Values	0	*	Off	
	1		On	
Related	<ul style="list-style-type: none"> <li>P832 TVT Shaper Adjust</li> </ul>			

Turn the TVT Shaper ON before using P832 and afterwards. Turn the TVT Shaper ON and OFF while monitoring the effect to pick up the true echo.

## P832 TVT Shaper Adjust

*Allows manual adjustment of the TVT curve. Use this parameter in conjunction with Dolphin Plus PC Software.*

Primary Index	Single Point Model	Dual Point Model
	Breakpoint	Transducer and Breakpoint
Values	Range: -50 to 50	
	Preset: 0	
Related	<ul style="list-style-type: none"><li>P831 TVT Shaper</li></ul>	

Use this feature to bias the shape of the TVT curve to avoid selecting false echoes from fixed objects.

Adjustment to this parameter is best done while viewing the echo profile with Dolphin Plus. Refer to the Dolphin Plus online help for details.

The TVT curve is divided into 40 breakpoints, accessible by enabling the point number as the breakpoint index field. Each breakpoint is normalized to a value of **0**, as displayed in the parameter value field. By changing the breakpoint value, up or down, the intensity of the bias applied to that breakpoint of the curve is respectively changed. By changing the value of adjacent breakpoints, the effective bias to the shaper can be broadened to suit the desired correction. In the case of multiple false echoes, shaping can be applied along different points of the curve. Shaping should be applied sparingly in order to avoid missing the true echo.

## P833 TVT Start Min

*Use this feature to adjust the TVT Curve height to ignore false echoes (or pick up true echoes) near the start of the Echo Profile.*

Primary Index	Single Point Model	Dual Point Model
	Global	Transducer
Values	Range: -30 to 225	
	Preset: 50	
Related	<ul style="list-style-type: none"><li>P800 Near Blanking</li><li>P834 TVT Start Duration</li></ul>	

Enter the minimum TVT Curve start point (in dB above 1 uV RMS).

This feature should only be used if increased Near Blanking (P800) would extend farther than desired into the measurement range.

## P834 TVT Start Duration

Use this feature in conjunction with TVT Start Min (P833) to ignore false echoes (or pick up true echoes) near the start of the Echo Profile.

Primary Index	Single Point Model	Dual Point Model
	Global	Transducer
Values	Range: 0 to 9999	
	Preset: 30	
Related	<ul style="list-style-type: none"><li>• P833 TVT Start Min</li><li>• P835 TVT Slope Min</li></ul>	

Enter the time (in ms) for the TVT Curve to decrease from the TVT Start Min (P833) point to the TVT Curve baseline.

## P835 TVT Slope Min

Enter the minimum slope (in dB/s) for the middle of the TVT Curve.

Primary Index	Single Point Model	Dual Point Model
	Global	Transducer
Values	Range: 0 to 9999	
	Preset: 200	
Related	<ul style="list-style-type: none"><li>• P830 TVT Type</li><li>• P834 TVT Start Duration</li></ul>	

Use this feature to adjust the slope declination, and use it in conjunction with TVT Start Duration (when a long flat TVT Type is selected) to ensure the TVT Curve remains above the false echoes in the middle of the Echo Profile. Alternatively, if TVT Type is set for **TVT Slopes** (P830 = 6), preset is 2000.

# P837 Auto False-Echo Suppression

Use P837 and P838 together, to set MultiRanger 100/200 to ignore false echoes. Use P838 to set the Auto TVT distance first.

## Notes:

- This function works best when the vessel is empty or nearly empty: use it only if there is a minimum distance of 2 meters from the transducer face to the material.
- Set P837 and P838 during start up, if possible.
- If the vessel contains an agitator, the agitator should be running.

If MultiRanger 100/200 displays a full level, or if the reading fluctuates between a false high level and a correct level, set P837 to elevate the TVT in this region and to desensitize the receiver from any 'base noise' caused by internal transducer reflections, nozzle echoes, or other vessel false echoes. Set P838 and then P837 (detailed instructions follow P838).

Values	0	*	Off
	1		Use 'learned' TVT. (See 'learned TVT curve' in Display after Auto False Echo Suppression on page 211.)
	2		Learn

## Display before Auto False Echo Suppression (or when P837 = 0)

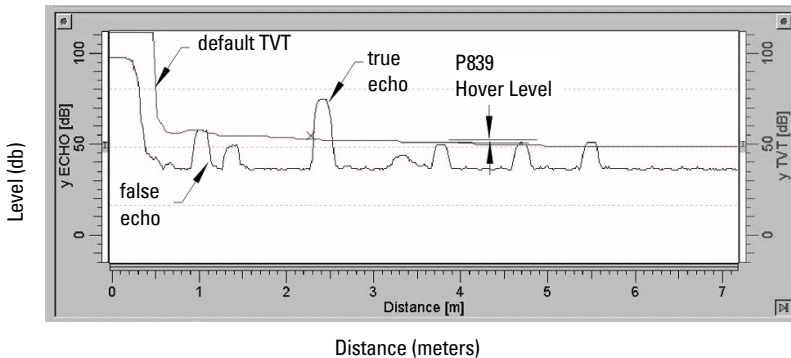



# P838 Auto False-Echo Suppression Distance

Defines the range of Auto False-Echo Suppression (P837) to use for ignoring false echoes. (Units are defined in P005.)

<b>Values</b>	Range (depends on model)	Maximum range: 0.000 to 15 m (50 ft)
	Default	1.000 m (3.28 ft)

Determine the actual distance from the transducer face to the material surface. Subtract 0.5 m from this distance, and enter the result.

## Set Up:

1. Perform this function when the vessel is empty or nearly empty.
2. Determine actual distance from transducer face to material level.
3. Select P838 and key in [distance to material level minus 0.5 m].
4. Press **ENTER** .
5. Select P837.
6. Press **2** and then press **ENTER** , P837 will revert to **1** (use Learned TVT) automatically after a few seconds.

## Display after Auto False Echo Suppression

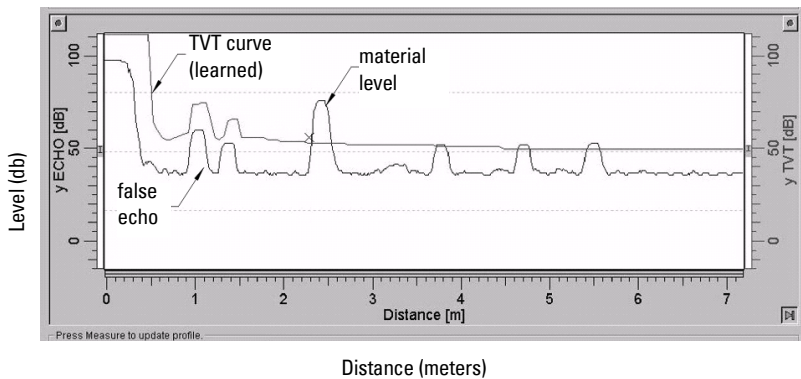

## P839 TVT Hover Level

Defines (in percent) how high the TVT curve is placed above the profile, relative to the largest echo. When MultiRanger 100/200 is located in the center of the vessel, lower this parameter to prevent multiple echo detections.

<b>Values</b>	Range	<b>0 to 100%</b>
	Default	<b>33 (%)</b>

# Advanced Shot Adjustment (P840 to P852)

These parameters are for Siemens Milltronics service personnel only.

## P840 Short Shot Number

*The number of short shots to be fired (and results averaged) per transmit pulse.*

Primary Index	Single Point Model	Dual Point Model
		Global
Values	Range: 0 to 100	
	Preset: 1	
Related	<ul style="list-style-type: none"> <li>• P841 Long Shot Number</li> <li>• P842 Short Shot Frequency</li> <li>• P844 Short Shot Width</li> <li>• P850 Short Shot Bias</li> <li>• P851 Short Shot Floor</li> <li>• P852 Short Shot Range</li> </ul>	

## P841 Long Shot Number

*Enter the number of long shots to be fired (and results averaged) per transmit pulse.*

Primary Index	Single Point Model	Dual Point Model
		Global
Values	Range: 0 to 200	
	Preset: 5	
Altered By	<ul style="list-style-type: none"> <li>• P003 Maximum Process Speed</li> </ul>	
Related	<ul style="list-style-type: none"> <li>• P840 Short Shot Number</li> <li>• P843 Long Shot Frequency</li> <li>• P845 Long Shot Width</li> </ul>	

This value is automatically altered by Maximum Process Speed (P003).

## P842 Short Shot Frequency

*Adjust the short shot transmit pulse frequency (in kHz).*

Primary Index	Single Point Model	Dual Point Model
		Global
Values	Range: 41 to 46 kHz, nearest acceptable value is returned	
Altered By	<ul style="list-style-type: none"> <li>• P004 Transducer</li> </ul>	
Related	<ul style="list-style-type: none"> <li>• P840 Short Shot Number</li> <li>• P844 Short Shot Width</li> <li>• P850 Short Shot Bias</li> <li>• P851 Short Shot Floor</li> <li>• P852 Short Shot Range</li> </ul>	

This feature is automatically altered when Transducer (P004) is altered.

## P843 Long Shot Frequency

*Adjust the long shot transmit pulse frequency (in kHz).*

Primary Index	Single Point Model	Dual Point Model
		Global
Values	Range: 41 to 46 kHz, nearest acceptable value is returned	
Altered By	<ul style="list-style-type: none"> <li>• P004 Transducer</li> </ul>	
Related	<ul style="list-style-type: none"> <li>• P841 Long Shot Number</li> <li>• P842 Short Shot Frequency</li> <li>• P843 Long Shot Frequency</li> <li>• P845 Long Shot Width</li> </ul>	

This feature is automatically altered when Transducer (P004) is altered.

## P844 Short Shot Width

*Adjust the width (in ms) of the short shot transmit pulse.*

Primary Index	Single Point Model	Dual Point Model
		Global
Values	Range: 0.000 to 5.000	
Altered By	<ul style="list-style-type: none"> <li>• P004 Transducer</li> </ul>	
Related	<ul style="list-style-type: none"> <li>• P840 Short Shot Number</li> <li>• P842 Short Shot Frequency</li> <li>• P845 Long Shot Width</li> <li>• P850 Short Shot Bias</li> <li>• P851 Short Shot Floor</li> <li>• P852 Short Shot Range</li> </ul>	

This feature is automatically altered when Transducer (P004) is altered.

## P845 Long Shot Width

Adjust the width (in ms) of the long shot transmit pulse.

Primary Index	Single Point Model	Dual Point Model
		Global
Values	Range: 0.000 to 5.000	
Altered By	<ul style="list-style-type: none"> <li>• P004 Transducer</li> </ul>	
Related	<ul style="list-style-type: none"> <li>• P841 Long Shot Number</li> <li>• P844 Short Shot Width</li> <li>• P843 Long Shot Frequency</li> </ul>	

This feature is automatically altered when Transducer (P004) is altered.

## P850 Short Shot Bias

Use this feature to slant the echo evaluation in favour of the short shot echo when both short and long shots are evaluated (see Shot Mode, P803).

Primary Index	Single Point Model	Dual Point Model
		Global
Values	Range: 0 to 100	
	Preset: 20	
Related	<ul style="list-style-type: none"> <li>• P803 Shot / Pulse Mode</li> <li>• P840 Short Shot Number</li> <li>• P842 Short Shot Frequency</li> <li>• P844 Short Shot Width</li> <li>• P851 Short Shot Floor</li> <li>• P852 Short Shot Range</li> </ul>	

## P851 Short Shot Floor

Enter the minimum echo strength (in dB above 1 uV) derived from a short shot to be considered for evaluation.

Primary Index	Single Point Model	Dual Point Model
		Global
Values	Range: 30 to 100	
	Preset: 50	
Related	<ul style="list-style-type: none"> <li>• P840 Short Shot Number</li> <li>• P842 Short Shot Frequency</li> <li>• P844 Short Shot Width</li> <li>• P850 Short Shot Bias</li> <li>• P852 Short Shot Range</li> </ul>	



# P852 Short Shot Range

Enter the maximum distance in Units (P005) to be measured using short shot echoes.

Primary Index	Single Point Model		Dual Point Model	
	Global		Transducer	
Values	Range: 0 to 10 m, or equivalent depending on units			
Altered By	<ul style="list-style-type: none"> <li>P004 Transducer</li> </ul>			
Related	<ul style="list-style-type: none"> <li>P840 Short Shot Number</li> <li>P842 Short Shot Frequency</li> <li>P844 Short Shot Width</li> <li>P850 Short Shot Bias</li> <li>P851 Short Shot Floor</li> </ul>			

This feature is automatically altered when Transducer (P004) is altered.

# Test (P900 to P913)

Test Parameters are intended for use by Siemens Milltronics Service personnel.

## P900 Software Revision Number

View the EPROM Rev. #.

Primary Index	Global
Values	Range: 00.00 to 99.99 (view only)

## P901 Memory

Press ENTER  to activate the MultiRanger memory test.

Primary Index	Global		
Values	Display: view only		
	PASS		(memory test successful)
	F1		RAM
	F3		FLASH data
	F4		FLASH code

## P902 Watchdog

Press **ENTER**  to put the CPU into an infinite loop to test the watchdog timer.

On successful completion (10 seconds) the RUN mode is entered and the MultiRanger is reset. Programming is kept and the unit responds as if there had been a power failure.

## P903 Display

Press **ENTER**  to activate the display test.

All LCD segments and symbols are temporarily displayed.

## P904 Keypad

Press **ENTER**  , then press each keypad key in the following sequence:



As each key is pressed, the associated keypad number is displayed. On successful test completion, **PASS** is displayed. **FAIL** is displayed if a key is pressed out of sequence or the programmer keypad malfunctions.

## P905 Transmit Pulse

Press **ENTER**  to supply repeated transmit pulses, at the frequency entered, to the transducer and / or view the transducer operating frequency (automatically altered by **P004 Transducer**) for the Point Number displayed.

Primary Index	Single Point Model	Dual Point Model
	Global	Transducer
Values	Range: 42kHz to 46KH (view only)	
Altered By	• P004 Transducer	

## P906 RS-232 Port

Press **ENTER**  to test the RS-232 port on the RJ-11.

An external device must be connected to the RS-232 port for this test. On successful completion, **PASS** is displayed, otherwise it is **FAIL**.

## P908 Scanner

Press **ENTER**  to cycle the scanner relay while firing the transmitter.

Use this parameter to ensure that both transducers are being stimulated.

## P910 Toggle Relays

Used to energize and de-energize relays directly.

<b>Primary Index</b>	Global
<b>Values</b>	0 to 6
<b>Related</b>	<ul style="list-style-type: none"><li>• P119 mA Relay Logic Test</li></ul>

Enter the relay number and then toggle between **energized** and **de-energized**, as required. Enter **0** to toggle all relays at once.

Applies only to relays with P119 = 0 (algorithm control). Use this parameter to confirm that relay contacts are opening and closing.

This feature is helpful when P119 does not give expected results even though programming was verified.

## P911 mA Output Value

Access this parameter to display the current value of the mA output.

<b>Primary Index</b>	mA output
<b>Values</b>	Range: 0.10 to 25.00
<b>Related</b>	<ul style="list-style-type: none"><li>• P200 mA Output Range</li><li>• P201 mA Output Function</li></ul>

Additionally, this feature may be used to enter a desired value. The mA output immediately assumes the value entered regardless of any restrictions programmed.

## P912 Transducer Temperature

Use this feature to display the temperature in °C (as monitored by the connected transducer).

<b>Primary Index</b>	Transducer
<b>Values</b>	Range: -50 to 150

**Err** is displayed if the transducer is not equipped with an internal temperature sensor.

# P913 Sensor Temperature

Access this parameter to display the temperature in °C (as monitored by the TS-3).

<b>Primary Index</b>	Global
<b>Values</b>	Range: -50 to 150

OPEN is displayed if a TS-3 is not connected.

# P914 mA Input [MR 200]

Use this feature to display the mA input value (in mA).

<b>Primary Index</b>	mA input
<b>Values</b>	Range: 0.000 to 24.00

# Measurement (P920 to P927)

All of these parameters are available in RUN mode and used to verify programming. See *Readings in RUN Mode* on page 23.

The range and values shown for each of these parameters depends on the Operation (P001) chosen. The readings for each operation are listed below.

## To Access in RUN Mode

1. Ensure the device is in RUN mode.
2. Press . The Auxiliary Reading field becomes underscores P\_ \_ \_ \_
3. Type the parameter number. The field changes to the value of the specified parameter.

These parameters are also available in simulation mode. See the *Testing the Configuration* section page 85 for instructions on how to control the simulation direction and rate.

# P920 Reading Measurement

*Corresponds to the final reading after all programming is applied.*

Please note that the following features apply only to the MultiRanger 200: Difference, Average, OCM, and Pump Totalizer.

<b>Primary Index</b>	Level
<b>Values</b>	Range: -999 to 9999

In general this means that:  $P920 = (\text{Reading} \times P061) + P062$ .

## Reading Measurements by Operation

P001	P050 = 0	P050 ≠ 0
0 – OFF	----	----
1 – Level	P921	P924
2 – Space	P922	100% - P924
3 – Distance	P927	P927
4 – Difference [MR 200]	P921 (indexed)	P921 (indexed)
5 – Average [MR 200]	P921 (indexed)	P921 (indexed)
6 – OCM [MR 200]	P925	P925
7 – Pump Totalizer [MR 200]	P924	P924

## P921 Material Measurement

*The distance in Units (P005) or % of Span (P007) between Empty (P006) and the monitored surface.*

<b>Primary Index</b>	Level
<b>Values</b>	Range: -999 to 9999 (view only)
<b>Related</b>	<ul style="list-style-type: none"> <li>• P005 Units</li> <li>• P006 Empty</li> <li>• P007 Span</li> </ul>

## P922 Space Measurement

*The distance between the monitored surface and Span (P007).*

<b>Primary Index</b>	Transducer
<b>Values</b>	Range: 0.000 to 9999 (view only)
<b>Related</b>	<ul style="list-style-type: none"> <li>• P007 Span</li> </ul>

## P923 Distance Measurement

*The distance between the monitored surface and the transducer face.*

<b>Primary Index</b>	Transducer
<b>Values</b>	Range: 0.000 to 9999 (view only)

## P924 Volume Measurement [MR 200]

*The calculated vessel capacity in Max Volume (P051) or % of Max Volume.*

Please note that Volume Measurement is a MultiRanger 200 feature only.

<b>Primary Index</b>	Level
<b>Values</b>	Range: 0.000 to 9999 (view only)
<b>Related</b>	<ul style="list-style-type: none"><li>P051 Maximum Volume</li></ul>

## P925 Flow Measurement [MR 200]

*The calculated flowrate in Max Flow (P604) units or % of Max Flow.*

Please note that Flow Measurement is a MultiRanger 200 feature only.

<b>Primary Index</b>	<b>Single Point Model</b>	<b>Dual Point Model</b>
	Global	Transducer
<b>Values</b>	Range: 0.000 to 9999 (view only)	
<b>Related</b>	<ul style="list-style-type: none"><li>P604 Maximum Flow</li></ul>	

## P926 Head Measurement [MR 200]

*Corresponds to Head (the distance from Zero Head (P605) to the monitored surface in Units (P005) or % of Span (P007).*

Please note that Head Measurement is a MultiRanger 200 feature only.

<b>Primary Index</b>	<b>Single Point Model</b>	<b>Dual Point Model</b>
	Global	Transducer
<b>Values</b>	Range: -999 to 9999 (view only)	
<b>Related</b>	<ul style="list-style-type: none"><li>P005 Units</li><li>P007 Span</li><li>P605 Zero Head</li></ul>	

## P927 Distance Measurement

*The distance between the surface and the transducer face (displays only as % of Empty).*

<b>Primary Index</b>	Transducer
<b>Values</b>	Range: 0.000 to 9999% (Displays as % of Empty) (view only)
<b>Related</b>	<ul style="list-style-type: none"><li>• P005 Units</li><li>• P006 Empty</li></ul>



Use P923 unless the distance information is required in percent.



## Master Reset (P999)

*This feature resets all parameters to original values.*

Primary Index	Single Point Model	Dual Point Model
	Global	Transducer
<b>Values</b>	See below.	

Use this feature prior to initial programming if arbitrary Parameter Values were used during a **bench test**, or after upgrading the software. Following a Master Reset, complete reprogramming is required.

To perform a Master Reset, access P999 and press CLEAR  . **C.ALL** displays until the reset is complete.

In dual point units, both points can be reset at the same time by setting the index to **00** and pressing the CLEAR   keys.

**CAUTION:** be careful when using this feature. All data for all points will be reset. For convenience, be sure to record the values you want to re-enter.

# Notes:

---



# Appendix A: Index Types

## Index types

Name	Description	# of indexes
Global	This parameter applies to the entire unit	n/a
View only	This parameter can not be set, only viewed	n/a
Breakpoint	Indexed by breakpoint	Parameter dependent
Dimension	Indexed by PMD dimension	up to 7
Discrete Input	Indexed by discrete input	2
Echo Profile	Indexed by stored echo profile	10
Level Point <sup>1</sup>	Indexed by level point	1, 2 or 3
mA input <sup>1</sup>	Indexed by mA input	1
mA output <sup>1</sup>	Indexed by mA output	0 or 2
Comm. Port	Indexed by communications port	2
Relay	Indexed by relay	3 or 6
Transducer <sup>2</sup>	Indexed by transducer	1 or 2

- MultiRanger 100:** The two level points are: Transducer One and Transducer Two.  
Level point typically has 1 index in Single Point Mode (standard), and 2 indexes in Dual Point Mode (optional).

**MultiRanger 200:** The three level points are: transducer 1, transducer 2, and the calculated point which can be difference (P001=4) or average (P001=5).  
Level point typically has 1 index in Single Point Mode (standard), and 2 indexes in Dual Point Mode (optional). A third index is available in both modes when Operation (P001) is set for DPD (P001=4) or DPA (P001=5).
- MultiRanger 200:** The number of indexes available in Single Point Mode (standard) is typically 1, but can be expanded to 2 if Operation (P001) is set for DPD (P001=4) or DPA (P001=5).  
In Dual Point Mode (optional), the number of available indexes is always 2.

# Appendix B: Technical Reference

## Transmit Pulse

The transmit pulse consists of one or more electrical “shot” pulses, which are supplied to the transducer connected to the MultiRanger terminals. The transducer fires an acoustic “shot” for each electrical pulse supplied. After each shot is fired, sufficient time is provided for echo (shot reflection) reception before the next (if applicable) shot is fired. After all shots of the transmit pulse are fired, the resultant echoes are processed. The transmit pulse shot number, frequency, duration, delay, and associated measurement range are defined by parameters P803 and P840 to P852.

## Echo Processing

Echo processing consists of echo enhancement, true echo selection, and selected echo verification.

Echo Enhancement is achieved by filtering (P821 and P822) and reforming (P823) the echo profile. The true echo (echo reflected by the intended target) is selected when that portion of the echo profile meets the evaluation criteria of Sonic Intelligence®. Insignificant portions of the echo profile outside of the measurement range (Span P006 + Range Extension P801), below the TVT Curve (P830, and P832 to P835), and less than the Confidence Threshold (P804) and Short Shot Floor (P851) are automatically disregarded. The remaining portions of the Echo Profile are evaluated using the Algorithm (P820) and Short Shot Bias (P850). The Echo Profile portion providing the best Echo Confidence (P805) is selected.

True echo verification is automatic. The position (relation in time after transmit) of the new echo is compared to that of the previously accepted echo. When the new echo is within the Echo Lock Window (P713), it is accepted and displays, outputs, and relays are updated per the Fuzz Filter (P710) and Rate Parameters (P700 to P703). If the new echo is outside of the Window, it is not accepted until Echo Lock (P711) requirements are satisfied.

## Dolphin Plus Display

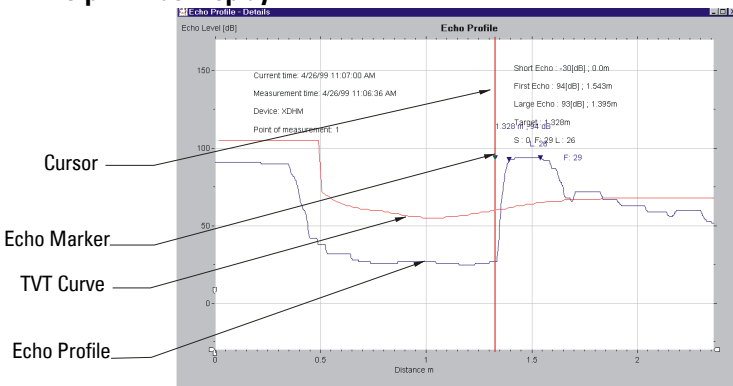

# TVT (Time Varying Threshold) curves

A TVT curve describes a threshold below which any echoes will be ignored. The default TVT curve is used, until P837 and P838 are used to create a new 'learned TVT curve'.

## Auto False-Echo Suppression

False echoes can be caused by an obstruction in the beam path (pipes, ladders, chains, and such). Such false echoes may rise above the default TVT curve.

P838 allows you to set a distance, and P837 then instructs the MultiRanger to 'learn' where the obstructions/false echoes are within that distance. The new TVT curve is set above the false echoes, screening them out.

### Display before Auto False Echo Suppression (or when P837 = 0)

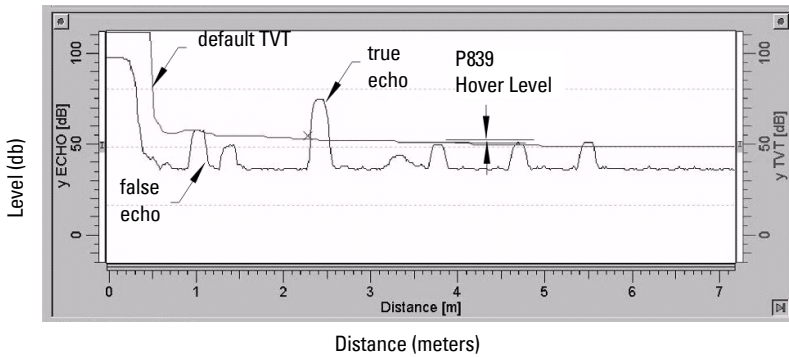

### Display after Auto False Echo Suppression

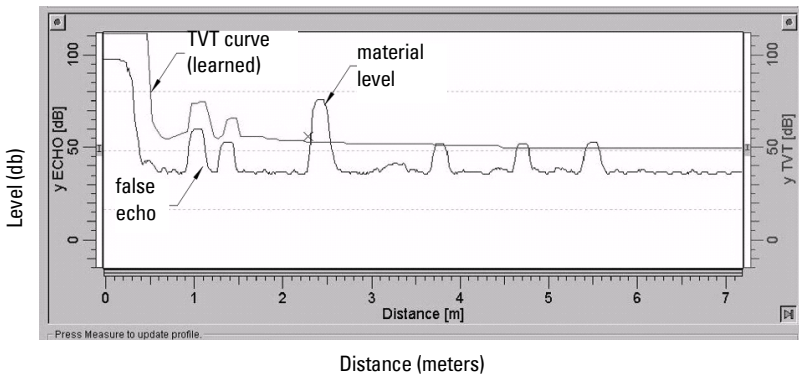

# Distance Calculation

To calculate the transducer to material level (object) distance, the transmission medium (atmosphere) sound velocity (P653) is multiplied by the acoustic transmission to reception time period. This result is divided by 2 to calculate the one way distance.

$$\text{Distance} = \text{Sound Velocity} \times \text{Time} / 2$$

The Reading displayed is the result of performing any additional modification to the calculated distance (as determined by Operation P001, Units P005, Volume Conversion, P050 to P054, Reading, P060 to P063, OCM, P600 to P611, and/or Totalizer P622 to P633 parameters).

## Sound Velocity

The sound velocity of the transmission medium is affected by the type, temperature, and vapor pressure of the gas or vapor present. As preset, the MultiRanger assumes the vessel atmosphere is air at 20°C (68°F). Unless altered, the sound velocity used for the distance calculation is 344.1 m / s (1129 ft / s).

Variable air temperature is automatically compensated when a Siemens Milltronics ultrasonic / temperature transducer is used. If the transducer is exposed to direct sunlight, use a sunshield or a separate TS-3 temperature sensor.

Also, if the temperature varies between the transducer face and the liquid monitored, use a TS-3 temperature sensor (submerged in the liquid) in combination with an ultrasonic / temperature transducer. Set Temp Source (P660) for **both**, to average the transducer and TS-3 measurements.

Atmosphere composition other than air can pose a challenge for ultrasonic level measurement. However, excellent results may be obtained by performing a Sound Velocity Calibration (P651) if the atmosphere is homogeneous (well mixed), at a fixed temperature, and under consistent vapor pressure.

The MultiRanger automatic temperature compensation is based on the sound velocity / temperature characteristics of "air" and may not be suitable for the atmosphere present. If the atmosphere temperature is variable, perform frequent Sound Velocity Calibrations to optimize measurement accuracy.

Sound Velocity calibration frequency may be determined with experience. If the sound velocity in two or more vessels is always similar, future calibrations may be performed on one vessel and the resultant Velocity (P653) entered directly for the other vessel(s).

If the sound velocity of a vessel atmosphere is found to be repeatable at specific temperatures, a chart or curve may be developed. Then, rather than performing a Sound Velocity Calibration each time the vessel temperature changes significantly, the anticipated Velocity (P653) may be entered directly.

# Scanning

## MultiRanger 100/200

When echo processing is complete (if more than 1 vessel is monitored) the scanning relay changes state to supply the transmit pulse to the other transducer after the Scan Delay (P727).

Scan Delay is automatically set by Maximum Process Speed (P003). When high speed scanning is required (sometimes the case for equipment position monitoring), the Scan Delay may be reduced. Reduce the Scan Delay only as required, otherwise premature scanning relay fatigue could occur.

## MultiRanger 200

When two transducers are connected and configured in a dual point unit, the MultiRanger will scan each in turn via the scanner relay. When a single point MultiRanger is programmed for **differential** or **average** level Operation (P001 = 4 or 5), two transducers of the same type must be used.

# Volume Calculation [MR 200]

Please note that the Volume Calculation feature is only available on the MultiRanger 200.

The unit provides a variety of volume calculation features (P050 to P055).

If the vessel does not match any of the eight preset Tank Shape calculations, a Universal Volume calculation may be used. Use the level/volume graph or chart provided by the vessel fabricator (or create one based on the vessel dimensions). Based on the graph, choose the Universal Volume calculation, and select the level vs. volume breakpoints to be entered (32 max). Generally, the more breakpoints entered, the greater the accuracy.

## Universal, Linear (P050 = 9)

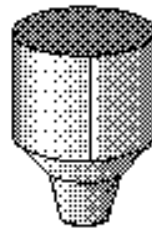

This volume calculation creates a piece-wise linear approximation of the level/volume curve. This option provides best results if the curve has sharp angles joining relatively linear sections.

Enter a Level Breakpoint at each point where the level/volume curve bends sharply (2 minimum).

For combination curves (mostly linear but include one or more arcs), enter numerous breakpoints along the arc, for best volume calculation accuracy.

## Universal, Curved [MR 200]

Please note that the Universal, Curved feature is only available on the MultiRanger 200.

Set P050 = 10

This calculation creates a cubic spline approximation of the level/volume curve, providing best results if the curve is non-linear, and there are no sharp angles.

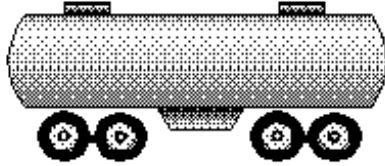

**Select at least enough breakpoints from the curve to satisfy the following:**

- two breakpoints very near the minimum level
- one breakpoint at the tangent points of each arc
- one breakpoint at each arc apex
- two breakpoints very near the maximum level

For combination curves, enter at least two breakpoints immediately before and after any sharp angle (as well as one breakpoint exactly at the angle) on the curve.

## Flow Calculation

Please note that the Flow Calculation feature is only available on the MultiRanger 200.

The MultiRanger provides numerous OCM flow calculation features (P600 to P611).

If the PMD (primary measuring device) does not match any of the eight preset PMD calculations, or if a PMD is not used, select a Universal Volume calculation. Use the head/flow graph or chart provided by the PMD fabricator (or create one based on the PMD or channel dimensions).

Based on the graph, choose the Universal Flow calculation, and select the head versus flow breakpoints to be entered (32 max). Generally, the more breakpoints entered, the greater the flow calculation accuracy.

## Universal, Linear [MR 200]

Please note that the Universal, Linear feature is only available on the MultiRanger 200.

Set P600 = 4.

This flow calculation creates a piece-wise linear approximation of the head/flow curve. This option provides best results if the curve has sharp angles joining relatively linear sections.

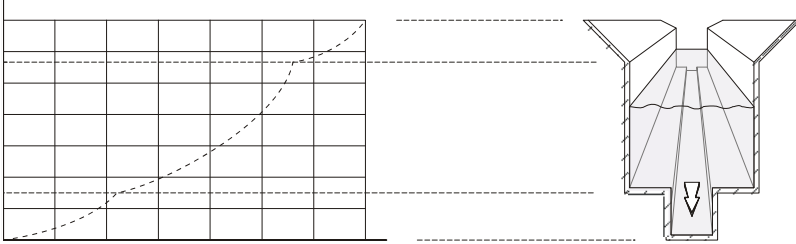

Enter a Head Breakpoint at each point where the head/flow curve bends sharply (2 minimum). For combination curves (mostly linear but include 1 or more arcs), enter numerous breakpoints along the arc, for best flow calculation accuracy.

See also *Typical Flow Characterization* on page 83.

## Universal, Curved [MR 200]

Please note that the Universal, Curved feature is only available on the MultiRanger 200.

This calculation creates a cubic spline approximation of the head/flow curve, providing best results if the curve is non-linear, and there are no sharp angles.

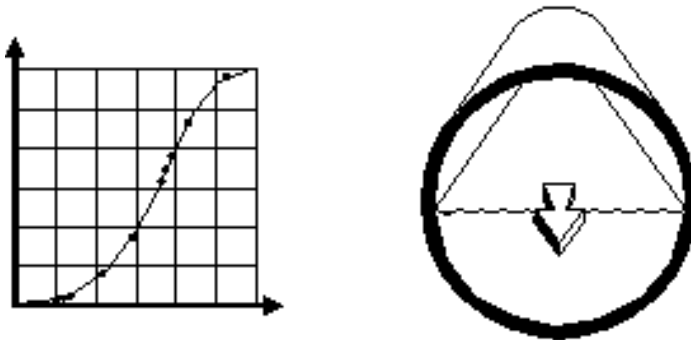

**Select at least enough breakpoints from the curve to satisfy the following:**

- two breakpoints very near the minimum head
- one breakpoint at the tangent points of each arc
- one breakpoint at each arc apex
- two breakpoints very near the maximum head

For combination curves, enter at least 2 breakpoints immediately before and after any sharp angle (as well as 1 breakpoint exactly at the angle) on the curve. For more information, go to *Typical Flow Characterization* on page 83.

## Maximum Process Speed

The MultiRanger's ability to respond to material level changes is designed to exceed even the most demanding installation requirements.

The Maximum Process Speed setting automatically presets various parameters affecting the MultiRanger response to material level changes as follows:

Parameter (units)	Values Dependent on Maximum Process Speed (P003)		
	1 (slow)	2 (medium)	3 (fast)
P070 Failsafe Timer (min)	100	10	1
P700 Max Fill Rate (m/min)	0.1	1	10
P701 Max Empty Rate (m/min)	0.1	1	10
P702 Filling Indicator (m/min)	0.01	0.1	1
P703 Emptying Indicator (m/min)	0.01	0.1	1
P704 Rate Filter (option)	4	2	2
P710 Fuzz Filter (% of Span)	100	50	10
P713 Echo Lock Window	per P701 / P702 and time since last valid measurement		
P727 Scan Delay (seconds)	5	5	3
P841 Long Shot Number	10	5	2

If any of these parameters are independently altered, a Maximum Process Speed (P003) parameter alteration automatically resets the independently altered value.

Slower Maximum Process Speed (P003) provides greater measurement reliability. Faster, independently set Max Fill (P700) and Max Empty (P701). Rates may be impeded by Echo Lock (P711), Scan Delay (P727), and Shot Delay (P728) values.



# Appendix C: Troubleshooting

**Note:** Many of the parameters and techniques described here require extensive knowledge of ultrasonic technologies and Siemens Milltronics echo processing software. Use this information with caution.

If the setup becomes too confusing use P999 to reset and start again.

## Common Problems Chart

Symptom	Cause	Action
Display blank, transducer not pulsing.	No power.	Check power supply, wiring, or power fuse.
No response to programmer.	Obstructed infrared interface, defective programmer.	Check programmer usage: 15 cm (6") from faceplate pointed at upper target.
Displays <b>Short</b> and <b>tb:(#)</b> .	Short circuited transducer cable, or defective transducer at indicated terminal block number.	Repair or replace as necessary.
Displays <b>Open</b> and <b>tb:(#)</b> .	Transducer not connected or connection reversed. Open circuited transducer cable, or defective transducer at indicated terminal block number.	Check connection to displayed terminal blocks. Repair or replace as necessary.
Displays <b>LOE</b> .	Weak or non-existent echo.	Relocate and/or re-aim transducer at material. Proceed to Measurement Difficulties.
Displays <b>Error</b> and <b>tb:(#)</b> .	Wrong transducer selected (P004).	Verify transducer type and re-enter value.
	Transducer connected in "two wire" method. Transducer connected backwards.	Do not tie white and shield together. Use all three terminal blocks. Reverse black and white wires on terminal block.
Displays <b>EEEE</b>	Value too large to display in 4 or 5 characters.	Select larger Units (P005), or lower Convert Reading (P061).
Displays <b>Error</b> and <b>F 16</b>	The last attempt to write to flash failed. Any changes have not been saved.	Try switching into calibration mode and back to run mode.
Displays <b>Error</b> and <b>F 17</b>	The contents of flash are corrupt. All calibration is lost.	The unit will need to be returned to be recalibrated.
Reading fluctuates while material level is still (or vice versa).	Incorrect measurement stabilization.	Alter Maximum Process Speed (P003) or damping (P704) accordingly. See <i>Maximum Process Speed</i> .
Reading is fixed, regardless of the actual material level.	Transducer acoustic beam obstructed, standpipe too narrow, or transducer ringing (reads over 100%).	Relocate and / or re-aim transducer at material level or object. Proceed to Measurement Difficulties below. See also: <i>Transducer Ringing</i> .
Material level reported is always incorrect by the same amount.	Incorrect Empty (zero) reference for level operation (P001 = 1).	See Empty (P006), Reading Offset (P063), Offset Calibration (P650), & Offset Correction (P652).

Measurement accuracy improves as level nears transducer.	Incorrect Sound Velocity used for distance calculation.	Use a transducer with a built-in temperature sensor or a TS-3 temperature sensor. See <i>Sound Velocity</i> .
Reading is erratic, with little or no relation to material level.	True echo too weak or wrong echo being processed.	Relocate and / or re-aim transducer at material. Check noise parameters. See <i>Noise Problems</i> .

## Noise Problems

Incorrect readings can be the result of noise problems, either acoustic or electrical, in the application.

The noise present at the input to the ultrasonic receiver can be determined by viewing parameter P807. The display reads ##.##, where the first number is the average noise and the second is the peak noise. In general, the most useful value is the average noise.

With no transducer attached the noise is under 5 dB. This is often called the noise floor. If the value with a transducer attached is greater than 5 dB, then signal processing problems can occur. High noise decreases the maximum distance that can be measured. The exact relationship between noise and maximum distance is dependent on the transducer type and the material being measured. Any average noise level greater than 20 dB is probably cause for concern unless the distance is much shorter than the maximum for the transducer.

### Determine the Noise Source

Disconnect the transducer from the MultiRanger. If the measured noise is below 5 dB, then continue here. If the measured noise is above 5 dB go to *Non-Transducer Noise Sources* below.

1. Connect only the shield wire of the transducer to the MultiRanger. If the measured noise is below 5 dB, continue with the next step. If the noise is above 5 dB, go to *Common Wiring Problems*.
2. Connect the white and black transducer wires to the MultiRanger. Record the average noise.
3. Remove the positive wire of the transducer. Record the average noise.
4. Re-connect the positive wire and remove the negative wire. Record the average noise.

Using the table below, determine the appropriate next step. The terms higher, lower and unchanged refer to the noise recorded in the previous steps.

These are guidelines only. If the suggested solution does not solve the problem, try the other options also.

- removed	+ removed	Go to:
-----------	-----------	--------

noise	higher	higher unchanged lower	Reducing Electrical Noise Common Wiring Problems Reducing Acoustical Noise
	unchanged	higher unchanged lower	Reducing Electrical Noise Contact Siemens Milltronics Reducing Acoustical Noise
	lower	higher unchanged lower	Common Wiring Problems Common Wiring Problems Reducing Acoustical Noise

### Acoustical Noise

To confirm that the problem is acoustical, place several layers of cardboard over the face of the transducer. If the noise is reduced, the noise is definitely acoustical.

## Non-Transducer Noise Sources

Remove all input and output cables from the MultiRanger individually while monitoring the noise. If removing a cable reduces the noise, that cable may be picking up noise from adjacent electrical equipment. Check that low voltage cables are not being run adjacent to high voltage cables or near to electrical noise generators such as variable speed drives.

Filtering cables is an option but is not recommended unless all other options have been exhausted.

The MultiRanger is designed to work near heavy industrial equipment such as variable speed drives. Even so, it should not be located near high voltage wires or switch gear.

Try moving the electronics to a different location. Often moving the electronics a few meters farther from the source of noise will fix the problem. Shielding the electronics is also an option, but it should be a last resort. Proper shielding is expensive and is difficult to install properly—the shielding box must enclose the MultiRanger electronics completely, and all wires must be brought to the box through grounded metal conduit.

## Common Wiring Problems

- Make sure that the transducer shield wire is connected at the electronics end only. Do not ground it at any other location.
- Do not connect the transducer shield wire to the white wire.
- The exposed transducer shield wire must be as short as possible.
- Connections between the wire supplied with the transducer, and any customer installed extension wire should be done in grounded metal junction boxes.

On Siemens Milltronics transducers the white wire is negative and the black wire is positive. If the extension wire is colored differently, make sure that it is wired consistently.

Extension wire must be shielded twisted pair. Older MultiRanger products may have included recommendations to use co-axial cable for noise reduction purposes. This is no longer the case. Use shielded twisted pair. See the installation section for specifications.

## Reducing Electrical Noise

- Ensure that the transducer cable does not run parallel to other cables carrying high voltage or current.
- Move the transducer cable away from noise generators like variable speed drives.

- Put the transducer cable in grounded metal conduit.
- Filter the noise source.

## Reducing Acoustical Noise

- Move the transducer away from the noise source.
- Use a stilling well.
- Install a rubber or foam bushing or gasket between the transducer and the mounting surface.
- Relocate or insulate the noise source.
- Change the frequency of the noise. The MultiRanger is only sensitive to noise between 25 KHz and 65 KHz.

## Measurement Difficulties

If the Failsafe Timer (P070) expires due to a measurement difficulty, LOE flashes alternately with the last known Reading. In rare cases, the MultiRanger may lock on to a false echo and report a fixed or wrong reading.

## Flashing LOE Display

The loss of echo (LOE) display appears when the echo confidence is below the threshold value set in P805 Echo Confidence.

### LOE occurs when:

- The echo is lost and no echo is shown above the ambient noise. See low echo confidence (P805) and low echo strength (P806).
- Two echoes are too similar to differentiate. See low echo confidence (P805) and low echo strength (P806).

### If LOE is displayed, check the following:

- Surface monitored is within the transducer maximum range
- Transducer model (P004) matches the transducer used
- Transducer is located and aimed properly
- Transducer is not submerged without a submergence shield

## Adjust Transducer Aiming

See the transducer manual for range, mounting, and aiming details. For optimum performance, adjust transducer aiming to provide the best Echo Confidence (P805) and Echo Strength (P806) for all material levels within the measurement range.

The most efficient method of checking echoes is with Siemens Milltronics Dolphin Plus software.

### Displaying Echoes

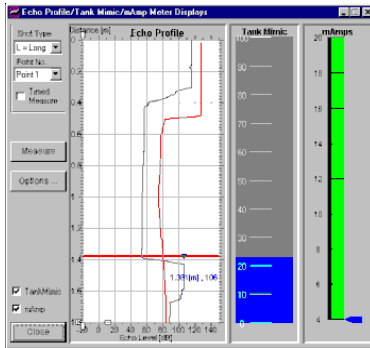

Use Dolphin Plus to graphically display the echo profile at the installation. Interpret the echo profile and change relevant parameters.

### Editing Parameters

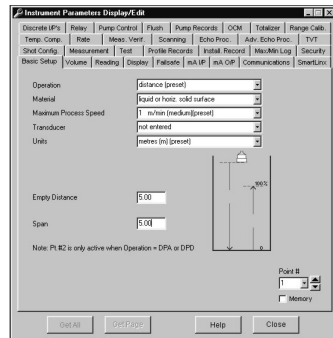

Edit the parameter values. Use F1 to get online help at any time.

### To display Echo Confidence in the RUN mode

Press  and hold for four seconds (Failsafe Time Left changes to the Short:Long Confidence display).

To display Echo Confidence in the program mode, access the Echo Confidence (P805) parameter.

To update the value displayed after each aiming adjustment..

Press  (five times or more to verify stability and overcome any echo lock P711).

### Increase Failsafe Timer Value

Increase the Failsafe Timer (P070) value, if failsafe operation will not be compromised by the larger value.

Try this only if LOE shows for short periods of time.

### Install a Transducer with a Narrower Beam

Sometimes the interference echoes from the sides of a vessel can cause the MultiRanger to lock onto a consistent, incorrect level. Try installing a longer range (narrower beam) transducer, enter the new transducer model (P004), and (if necessary) optimize aiming and frequency again.

Always contact your Siemens Milltronics service personnel before selecting a transducer to solve this type of problem.

## Use Dolphin Plus to Debug Echo

If a narrower beam transducer is not available, use Dolphin Plus to view live sonic profiles and make adjustments to the Advanced Echo Processing parameters.

## Fixed Reading

If the Reading is a fixed value, regardless of the transducer to material surface distance, ensure the:

1. Transducer acoustic beam is free from obstruction.
2. Transducer is properly aimed
3. Transducer is not in contact with any metal object.
4. Material mixer (if used) is operating while the MultiRanger is operating. If it is stopped, ensure that the mixer blade is not stopped under the transducer.

## Obstructions in the Sound Beam

Check for (and remove if present) any acoustic beam obstruction, or relocate the transducer.

If an obstruction cannot be removed or avoided, adjust the Time Varying Threshold (TVT) Curve to reduce the Echo Confidence derived from the sound reflected by the obstruction. Use Dolphin Plus to adjust the TVT curve. (See *P832: TVT Shaper*.)

## Nozzle Mountings

If the transducer is mounted on or in a nozzle, grind smooth any burrs or welds on the inside or open end (the end that opens into the vessel). If the problem persists, install a larger diameter or shorter length nozzle, bevel the inside of the bottom end, or cut the open end of the nozzle at a 45° angle.

See the transducer manual for complete mounting instructions.

For ST-series and XPS-10 transducers use the plastic conduit / flange adapter supplied with the unit.

If the mounting hardware is over tightened, loosen it. Over tightening changes the resonance characteristics of the transducer and can cause problems.

## Set the MultiRanger to Ignore the Bad Echo

If the preceding remedies have not fixed the problem, the false echo has to be ignored.

### If the Echo is Close to the Transducer

If there is a static, incorrect, high level reading from the MultiRanger there is probably something reflecting a strong echo back to the transducer. If the material level never reaches that point extend the Near Blanking (P800) to a distance to just past the obstruction.

### Adjust the TVT to Ignore the Echo

Use Auto False Echo Suppression (P837-P839) to automatically shape around false echoes.

# Wrong Reading

If the Reading is erratic, or jumps to some incorrect value periodically, ensure the:

1. Surface monitored is not beyond the MultiRanger's programmed range or the transducer's maximum range.
2. Material is not falling into the transducer's acoustic beam.
3. Material is not inside the blanking distance of the transducer.

## Types of Wrong Readings

If a periodic wrong Reading is always the same value, see *Fixed Reading*.

If the wrong Reading is random, ensure the material surface to transducer distance is less than the Empty value entered plus 20%. If the material/object monitored is outside this distance, increase Range Extension (P801) as required. This error is most common in OCM applications using weirs.

## Liquid Splashing

If the material monitored is a liquid, check for splashing in the vessel. Enter a lower Maximum Process Speed (P003) value to stabilize the Reading, or install a stilling well. (Contact Siemens Milltronics or your local distributor.)

## Adjust the Echo Algorithm

Use Dolphin Plus to view live sonic profiles and make adjustments to the P820 Algorithm parameter. See P820 on page 204 for details.

If the "Area" algorithm is used and narrow noise spikes are evident on the (long shot) Echo Profile, turn the Spike Filter (P821) on and/or widen the Narrow Echo Filter (P822). Also, if the true echo has jagged peaks, use Reform Echo (P823).

If multiple echoes appear on the Echo Profile, typical of a flat material profile (especially if the vessel top is domed), use the "first" Algorithm.

If the Echo Profile repeatedly switches from short to long, adjust the Short Shot Range (P852) to stabilize the "shot" mode used for the echo evaluation. Also, adjust the Short Shot Bias to increase (or decrease the amount of preference given to short shot echoes over long shot echoes.

Should a stable measurement still not be attainable, contact Siemens Milltronics or your local distributor.

## Transducer Ringing

If the transducer is mounted too tightly, or if it is mounted so that its side touches something, its resonance characteristics change and this can cause problems.

### Normal Ring Down

### Poor Ring Down

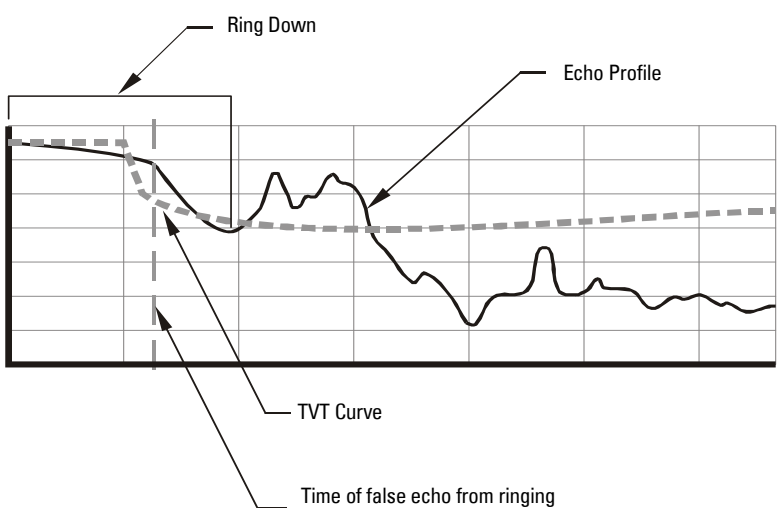
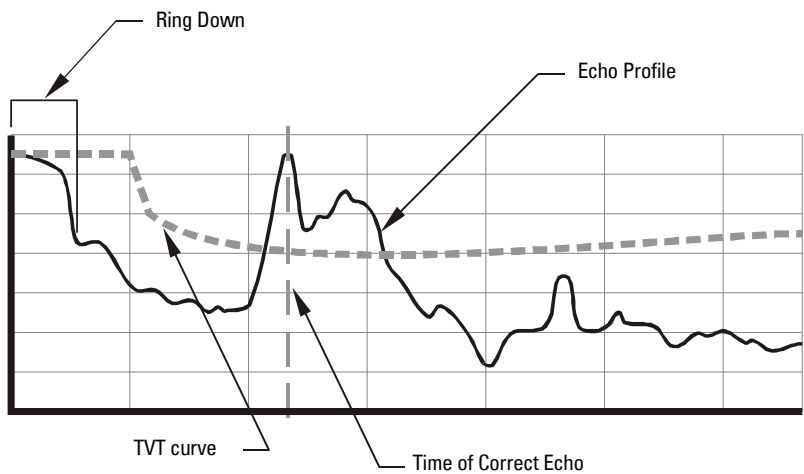

Ring down times that extend past the near blanking area can be interpreted by the MultiRanger as the material level and are characterized by a steady high level being reported.

## Unit Repair and Excluded Liability

All changes and repairs must be done by qualified personnel and applicable safety regulations must be followed. Please note the following:

- The user is responsible for all changes and repairs made to the device.
- All new components must be provided by Siemens Milltronics Process Instruments Inc.
- Restrict repair to faulty components only
- Do not re-use faulty components.



# Appendix D: Pump Control Reference

---

Please note that some pump control features apply to the MultiRanger 200 only.

The MultiRanger has the pump control strategies to solve nearly any water / wastewater application. This section details these strategies for engineers requiring in-depth knowledge of the system and how it operates.

## Pump Control Options

The various methods of pump control are made up of a combination of two control variables:

### Pump Duty

The pump duty indicates in what sequence pumps are started.

### Pump Start Method

The start method indicates whether new pumps start and run with any currently running pumps (most common) or whether new pumps start and shut off currently running pumps.

## Pump Groups

The MultiRanger groups pumps that use identical pumping strategies based on the value of Relay Control Function (P111). Generally, one group of pumps corresponds to one wet well or reservoir.

## Pump by Rate [MR 200]

Please note that this feature applies to the MultiRanger 200 only.

To trigger pump starts by the rate of change in material level use P121—Pump by Rate (P121). New pumps are started, one at a time, until the rate setpoint (Filling Indicator (P702), or Emptying Indicator(P703)) is reached.

## Pump Control Algorithms

Please note that the MultiRanger 100 and the MultiRanger 200 use this feature differently.

### MultiRanger 100

All of these algorithms can be used to start multiple pumps (assist).

### MultiRanger 200

All of these algorithms can be used to start multiple pumps (assist) or one pump at a time (backup).

### **The MultiRanger 100 and MultiRanger 200 have three main methods of pump control:**

#### **Fixed**

Starts pumps based on individual setpoints and always starts the same pumps in the same sequence.

#### **Alternate**

Starts pumps based on the duty schedule and always leads with a new pump.

#### **Service Ratio**

Starts pumps based on user-defined ratio of running time.

## **Fixed Duty Assist (P111 = 50)**

*Ties the indexed pump relay directly to the indexed setpoint.*

### **Relay Operation (for P118 = 2)**

The relay contact closes at the ON setpoint and opens at the OFF setpoint. Multiple relay contacts in the pump group can be closed at the same time.

### **Relay Table**

The following table shows relay status when each setpoint is reached.

Setpoints	Index	Relays		
		1	2	3
On 3		On	On	On
On 2		On	On	Off
On 1		On	Off	Off
Off 0		Off	Off	Off

## **Fixed Duty Backup (P111 = 51) [MR 200]**

*Ties the indexed pump relay directly to the indexed setpoint.*

Please note that this feature applies to the MultiRanger 200 only.

### **Relay Operation (for P118 = 2)**

The relay contact closes at the ON setpoint and opens at the OFF setpoint. When a new relay trips the previously closed relay contact opens to shut down the running pump.

Only one relay contact in the pump group can be closed at any one time.

### **Relay Table**

The following table shows relay status when each setpoint is reached.

Setpoints	Index	Relays		
		1	2	3
On 3		Off	Off	On
On 2		Off	On	Off
On 1		On	Off	Off
Off 0		Off	Off	Off

## Alternate Duty Assist (P111 = 52)

*Alternates the lead pump each time the material level cycles and runs all pumps together.*

### Relay Operation (for P118 = 2)

The setpoints associated with the relays are grouped so that they can be rotated.

Setpoint one does not relate directly to relay one. The pumping algorithm manages the mapping of setpoints to relays.

When pumps are run, they RUN in parallel.

### Relay Table

Cycle 1		Relays		
Setpoints		1	2	3
	On 3	On	On	On
	On 2	On	On	Off
	On 1	On	Off	Off
	Off 0	Off	Off	Off
Cycle 2		Relays		
Setpoints		1	2	3
	On 3	On	On	On
	On 2	Off	On	On
	On 1	Off	On	Off
	Off 0	Off	Off	Off
Cycle 3		Relays		
Setpoints		1	2	3
	On 3	On	On	On
	On 2	On	Off	On
	On 1	Off	Off	On
	Off 0	Off	Off	Off

## Alternate Duty Backup (P111 = 53) [MR 200]

*Alternates the lead pump each time the material level cycles.*

Please note that this feature applies to the MultiRanger 200 only.

### Relay Operation (for P118 = 2)

The setpoints associated with the relays are grouped so that they can be rotated.

Setpoint one does not relate directly to relay one. The pumping algorithm manages the mapping of setpoints to relays. When pumps are run, they can RUN only one at a time.

## Relay Table

Cycle 1		Relays		
Setpoints		1	2	3
	On 3	Off	Off	On
	On 2	Off	On	Off
	On 1	On	Off	Off
	Off 0	Off	Off	Off

Cycle 2		Relays		
Setpoints		1	2	3
	On 3	On	Off	Off
	On 2	Off	Off	On
	On 1	Off	On	Off
	Off 0	Off	Off	Off

Cycle 3		Relays		
Setpoints		1	2	3
	On 3	Off	On	Off
	On 2	On	Off	Off
	On 1	Off	Off	On
	Off 0	Off	Off	Off

## Service Ratio Duty Assist (P111 = 54) [MR 200]

*Selects the lead pump based on number of hours each pump has run and the specified ratios that each pump requires. Multiple pumps can run at one time.*

Please note that this feature applies to the MultiRanger 200 only.

### Relay Operation (for P118 = 2) [MR 200]

Please note that this feature applies to the MultiRanger 200 only.

The setpoints associated with the relays are grouped so they can be redistributed based on pump RUN time ratios. The next pump to start or stop is the one with the required time to actual time ratio.

Over time the number of hours demanded of each pump will conform to the ratios specified. Usually, the ratios are specified in percent values.

To create a grouping of pumps where two pumps make up 50% of the run time and the third pump makes up the other 50%.

P122 is set to these values:

P122 Index	Value
1	25
2	25
3	50

## Service Ratio Duty Backup (P111 = 55) [MR 200]

*Selects the lead pump based on number of hours each pump has RUN and the specified ratios that each pump requires. Only one pump can RUN at a time.*

Please note that this feature applies to the MultiRanger 200 only.

This algorithm is the same as Service Ratio Duty Assist except that it will only RUN one pump at a time. When the next pump in the sequence starts, the previous pump stops.

## First In First Out (FIFO) (P111 = 56) [MR 200]

*Selects the lead pump based on the **Alternate** duty but uses staggered off setpoints and shuts down pumps based on the **first in, first out** rule.*

Please note that this feature applies to the MultiRanger 200 only.

This algorithm starts pumps in the same way as Alternate Duty Assist but uses staggered OFF setpoints to shut the pumps down. When the first OFF setpoint is reached the FIFO rule shuts down the first pump started. If the pumps started in sequence 2,3,1 then they would be shut down in sequence 2,3,1.

## Pump by Rate (P121) [MR 200]

*Starts pumps until the level is changing at the rate specified in P702 or P703.*

Please note that this feature applies to the MultiRanger 200 only.

Pumping costs can be less because only the highest ON setpoint needs to be programmed and this results in a lower difference in head to the next wet well which, in turn, results in less energy being used to pump out the well.

## Other Pump Controls [MR 200]

Please note that these features apply to the MultiRanger 200 only.

There are a number of other controls available to modify pump behaviour.

### **Pump Run-On (P130, P131)**

Extends the RUN period for a pump based on a set time interval. This allows for the wet well to be pumped lower than usual and reduces sludge build-up on the well bottom.

### **Wall Cling Reduction (P136)**

Varies the ON and OFF setpoints to keep a fat ring from forming around the walls of the wet well.

### **Pump Group (P137)**

Allows for two different Alternate Duty Assist or Alternate Duty Backup pump groups in the same application.

## **Flush Device (P170 to P173)**

Operates a flush valve or special flush device based on the number of pump starts, usually to aerate wet well wastewater.

# Appendix E: Updating Software

---

## Updating Software

To update the software in the MultiRanger, please contact your Siemens Milltronics representative to obtain the software. For a complete list of representatives, go to [www.siemens.com/processautomation](http://www.siemens.com/processautomation).

### **WARNINGS:**

- 1. All parameter values will be lost during software upgrade. Record your current parameters manually or using Dolphin Plus or SIMATIC PDM before upgrade.**
- 2. Disable all pumps and alarms before updating software, as relays can change state during the software update causing pumps to turn on or off .**

To install the software, please complete the following:

1. Connect your PC or laptop to the MultiRanger RJ-11 RS-232 port.
2. Run the .exe Downloader program in the software. Use this to set the RS-232 settings to match your MultiRanger. Please note that the software default settings will already match the default settings of the unit. Changes are only necessary if the RS-232 settings in the unit have been changed.
3. Complete the Downloader program steps.
4. Verify that Downloader confirms a successful upgrade before exiting.
5. Complete a Master Reset (P999) after a successful upgrade, before re-entering parameters.

# Appendix F: Upgrading

The following procedure will assist you if you are upgrading from a MultiRanger Plus to a MultiRanger 100 or MultiRanger 200.

If the application is unchanged, copy down the parameters in the MultiRanger Plus before de-commissioning the unit.

## Mounting a MultiRanger 100/200

Please read the MultiRanger *Installation* section on page 8 before mounting the new MultiRanger 100/200.

Make sure the power is OFF to the unit before following these steps:

1. Remove the old MultiRanger Plus.
2. Mount the new MultiRanger 100/200 using the same mounting holes.

## Connecting the Transducer

**Important:** Unlike the MultiRanger Plus, coaxial cable is not recommended for use with the MultiRanger 100/200 for transducer cable extensions. The MultiRanger 100/200 circuit is designed to use shielded twisted pair cable. Ideally, the coaxial cable should be replaced with twisted pair.

If this is not practical, please refer to the Coaxial Transducer Extension section below.

## Coaxial Transducer Extension

The MultiRanger 100/200 uses a new differential input receiver that works either directly connected to the transducer lead or with a screened twisted pair extension cable via a field junction box. This arrangement, using two conductors and a screen, gives considerably better electrical noise immunity than the previous coaxial arrangement (up to 20dB) and will give reliable operation in applications where the proximity of power cables, variable speed drives etc. would have caused problems.

If you are installing a new MultiRanger system we strongly recommend that you use a good quality screened, twisted pair cable if an extension is required. If the integral transducer cable is used you need only connect to the MultiRanger and benefit from the superior performance.

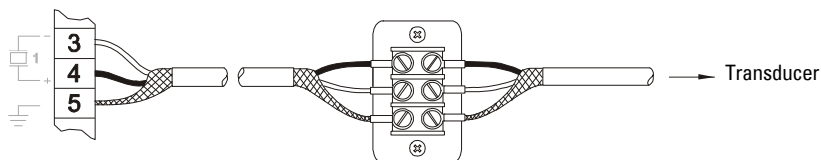



## Connecting a transducer with RG62 coaxial extension cable

If you are replacing an older Siemens Milltronics Ultrasonic Level Controller with a new MultiRanger where an RG62 coaxial extension is fitted and you are unable to replace the extension with a new cable, please refer to connection diagram below. Please note that the noise immunity performance will be similar to our older model ultrasonic level controllers if you use coaxial cable.

### Existing installation

RG62 coaxial cable has been used to make the extension. The level controller might be a MultiRanger Plus, HydroRanger, HydroRanger Plus or one of our other level controllers.

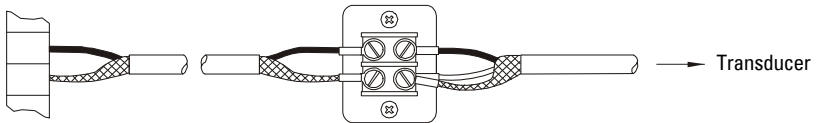

### MultiRanger 100/200 Installation (for retrofitting MultiRanger Plus Installations)

Connect with a  $0.1\mu\text{F}$  (100v or greater) capacitor (included with MultiRanger) between the shield and negative terminals. Connect centre core of the coaxial to the positive terminal and the screen to the negative terminal.

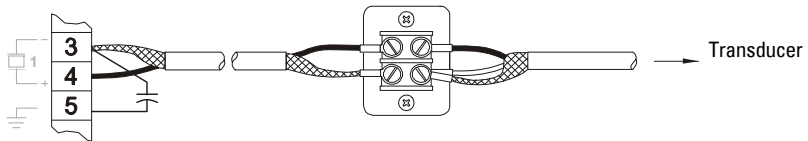

## MultiRanger Plus to MultiRanger 100/200 Parameters

The MultiRanger 100/200 uses the current Siemens Milltronics standard parameter set which is different than the parameter numbers used in the MultiRanger Plus.

The MultiRanger Plus parameters numbers are sequential (P-0 to P-99). The MultiRanger 100/200 parameters number are also sequential; however, some of the parameters are indexed.

Parameters are indexed when they apply to more than one input or output. The index value defines the input/output for that parameter. Indexed parameters contain a value for each index, even if that index is not used.

### Example

In the MultiRanger Plus each relay had a dedicated parameter number for its function, ON and OFF points.

#### MultiRanger Plus Relay One

- P-8: Function
- P-9 : ON setpoint
- P-10: OFF setpoint

MultiRanger 100/200 uses P111 for all relays and indexes these parameters.

- P-111: Function
- P-112: ON
- P-113: OFF

The following tables show the differences between the MultiRanger Plus and the MultiRanger 100/200. They each show one relay programmed as a high alarm, and two relays programmed for pump control with alternating pump starts:

#### MultiRanger Plus

Relay	Parameter	Value
1	P-8 (relay function)	1 (alarm)
1	P-9 (ON setpoint)	4 m
1	P10 (OFF setpoint)	3.5 m
2	P-11 (relay function)	9
2	P-12 (ON setpoint)	3.2 m
2	P-13 (OFF setpoint)	0.5 m
3	P-14 (relay function)	9
3	P-15 (ON setpoint)	3.4 m
3	P-16 (OFF setpoint)	0.6 m

#### MultiRanger 100/200

Relay	Parameter	Value
1	P111 [1] (relay function)	1
1	P112 [1] (ON setpoint)	4 m
1	P113[1] (OFF setpoint)	3.5 m
2	P111[2] (relay function)	52
2	P112[2] (ON setpoint)	3.2 m
2	P113[2] (OFF setpoint)	0.5 m
3	P111[3] (relay function)	52
3	P112[3] (ON setpoint)	3.4 m
3	P113[3] (OFF setpoint)	0.6 m

# Appendix G: Conduit Entry for Class 1, Div 2 Applications

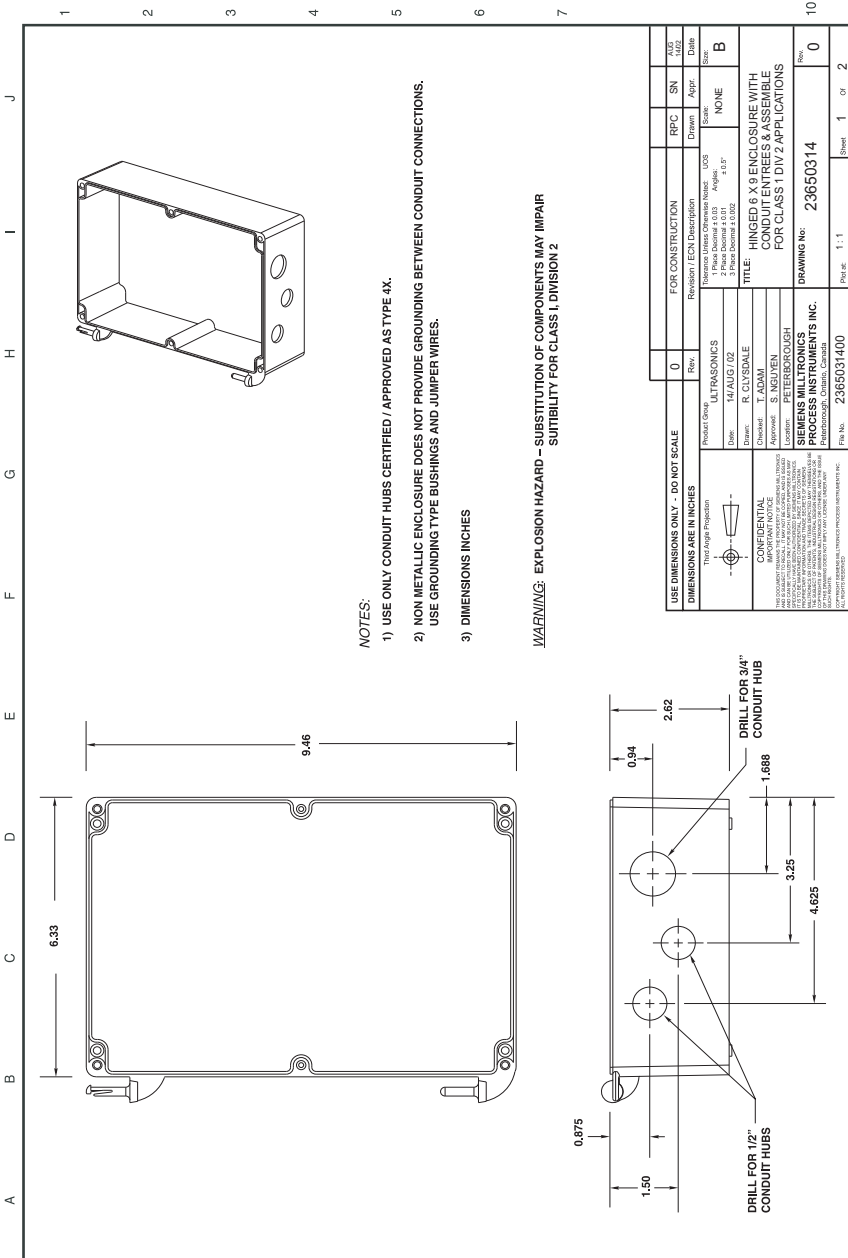

# Appendix G

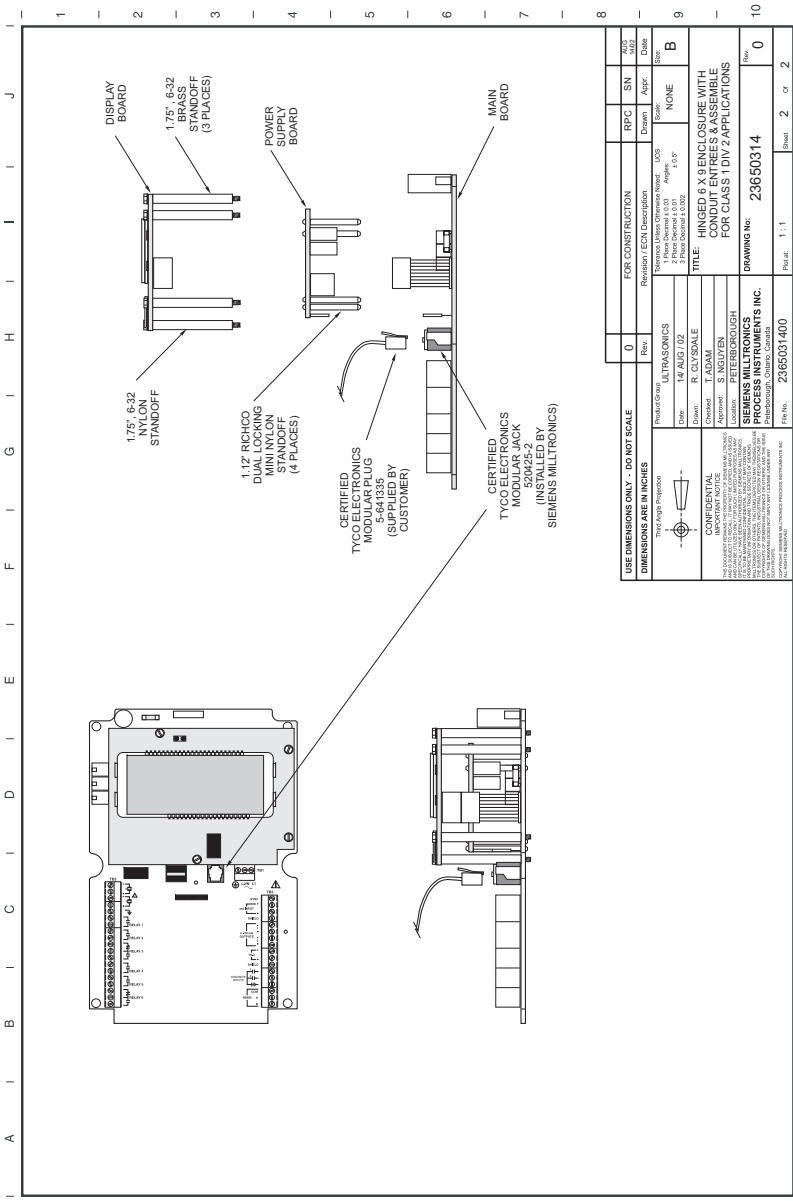

USE DIMENSIONS ONLY - DO NOT SCALE		0	FOR CONSTRUCTION	RPC	SN	REV
DIMENSIONS ARE IN INCHES		Rev:	Revision ECR Description	Drawn:	Appr:	Date
Title: ULTRASONICS		1	1 Phase Detail 4.0.03	None	None	B
Drawn: R. CUNYALE		2	2 Phase Detail 4.0.02			
Date: 14/ AUG 02		APPROVED FOR CONSTRUCTION				
BY: J. ADAMSON		FOR: SIEMENS				
CHECKED BY: J. ADAMSON		LOCATION: PETERBOROUGH				
SIEMENS MULTITRONICS		PROCESS INSTRUMENTS INC.				
Drawing No: 23650314		Rev: 0				
Part No: 2365031400		Sheet: 1 - 1				
		Total: 2				

# Appendix H: Hazardous Area Installations

---

## Panel mount:

### Instructions specific to hazardous area installations (Reference European ATEX Directive 94/9/EC, Annex II, 1/0/6)

The following instructions apply to equipment covered by certificate number SIRA06ATEXT9163X:

1. For use and assembly, refer to the main instructions.
2. The equipment is certified for use as Category 3D equipment.
3. The equipment may be used in hazardous zone 22 except for conductive dusts (e.g., metal or carbon dusts).
4. This equipment has a maximum surface temperature of T75 C (in a 50°C ambient). Refer to the applicable Code Of Practice for selection of this equipment with respect to specific dust ignition temperatures.
5. The equipment is certified for use in an ambient temperature range of -20 C to 50 C.
6. Any cable or conduit entries must meet the requirements of European Directive 94/9/EC for Group II, Category 3D and maintain the overall IP rating of the enclosure.
7. Cable should be selected in accordance with the applicable Code of Practice and such that its insulation can withstand the maximum surface temperature of the enclosure (T75°C).
8. The equipment has not been assessed as a safety related device (as referred to by Directive 94/9/EC Annex II, clause 1.5).
9. Installation and inspection of this equipment shall be carried out by suitably trained personnel in accordance with the applicable code of practice (EN 60079-14 and EN 60079-17 in Europe).
10. Repair of this equipment shall be carried out by suitably trained personnel in accordance with the applicable code of practice (e.g. EN 60079-19 within Europe).
11. Components to be incorporated into or used as replacements in the equipment shall be fitted by suitably trained personnel in accordance with the manufacturer's documentation.
12. Manual override can be accomplished by using the disconnect switch provided in the building installation.

## Wall mount:

### Instructions specific to hazardous area installations (Reference European ATEX Directive 94/9/EC, Annex II, 1/0/6)

The following instructions apply to equipment covered by certificate number SIRA06ATEX9163X:

1. For use and assembly, refer to the main instructions.
2. The equipment is certified for use as Category 3D equipment.
3. The equipment may be used in hazardous zone 22.
4. This equipment has a maximum surface temperature of T75 C (in a 50°C ambient). Refer to the applicable Code Of Practice for selection of this equipment with respect to specific dust ignition temperatures.
5. The equipment is certified for use in an ambient temperature range of -20 C to 50 C.
6. Any cable or conduit entries must meet the requirements of European Directive 94/9/EC for Group II, Category 3D and maintain the overall IP rating of the enclosure.
7. Cable should be selected in accordance with the applicable Code of Practice and such that its insulation can withstand the maximum surface temperature of the enclosure (T75°C).
8. The equipment has not been assessed as a safety related device (as referred to by Directive 94/9/EC Annex II, clause 1.5).
9. Installation and inspection of this equipment shall be carried out by suitably trained personnel in accordance with the applicable code of practice (EN 60079-14 and EN 60079-17 in Europe).
10. Repair of this equipment shall be carried out by suitably trained personnel in accordance with the applicable code of practice (e.g. EN 60079-19 within Europe).
11. Components to be incorporated into or used as replacements in the equipment shall be fitted by suitably trained personnel in accordance with the manufacturer's documentation.
12. Manual override can be accomplished by using the disconnect switch provided in the building installation

# Appendix J: Software Revision History

---

## MultiRanger 100

Software Rev.	Date	Changes
1.00	Aug. 15, 2005	<ul style="list-style-type: none"><li>• Pilot Release.</li></ul>
1.01	Sept. 21, 2005	<ul style="list-style-type: none"><li>• Internal Release.</li></ul>
1.02	Dec. 12, 2001	<ul style="list-style-type: none"><li>• Initial Release.</li></ul>
1.03	Aug. 27, 2002	<ul style="list-style-type: none"><li>• Clarified return message for factory RS232 test.</li><li>• Prevent entering of strings with invalid fields in Dolphin Plus.</li><li>• Properly convert ft/sec to m/sec in P654.</li><li>• Eliminated rogue watchdog resets from repeatedly pressing hand programmer enter while in P901-P90.</li><li>• Allow 32 bit read/write as seconds.</li><li>• Factory mode lock is written to flash.</li><li>• Cleaned up compiler errors and Lint warnings.</li><li>• Modified handling of non-quick start parameters.</li><li>• Modifications for Production Testing.</li><li>• Users may now configure the SmartLinx memory map.</li></ul>

<b>Software Rev.</b>	<b>Date</b>	<b>Changes</b>
1.04 1.05	Feb. 11, 2003 Feb. 23, 2003	<ul style="list-style-type: none"> <li>• Product enhancements to eliminate relay chatter on software download.</li> <li>• Improved functionality of receiver saturation during calibration.</li> <li>• Added relay functionality through P118 to coincide with manual.</li> <li>• Improved product security with addition of P069.</li> <li>• Backup level override behaviour improvement.</li> <li>• Improved mA control with P210 - P213.</li> <li>• Improved temperature calibration in factory mode.</li> <li>• Improved Production Testing support.</li> <li>• Improved reset behaviour.</li> <li>• Changed default mA trim values.</li> <li>• Improved functionality of downloading breakpoints in Dolphin Plus.</li> </ul>
1.06	May 27, 2004	<ul style="list-style-type: none"> <li>• RCVR offset limits are no longer handled in the code.</li> </ul>
1.07	Aug. 30, 2004	<ul style="list-style-type: none"> <li>• P060, P005 Dependency removed.</li> <li>• Split Values - Parameters with the "xx:yy" format now being limited properly.</li> <li>• Temperature Spike - Temperature readings now being protected from other units' transmit pulse.</li> <li>• TVT Shift - A rounding error in the number of samples, caused the TVT position to shift.</li> <li>• Auto False Echo Suppression - Device learns the shape of an empty tank to automatically suppress false echos.</li> <li>• SIMATIC PDM Compatability - Device uses Modbus to communicate with SIMATIC PDM. DDs required.</li> </ul>



<b>Software Rev.</b>	<b>Date</b>	<b>Changes</b>
1.08	Nov. 11, 2004	<ul style="list-style-type: none"> <li>• Improvements made as a result of Siemens systems testing:</li> <li>• SIMATIC PDM related: TVT display improvement to prevent it from going negative. MLFB number includes SMPI as well as Siemens numbering. Change of some enumerations in the Device Description.</li> <li>• Device related: mA output no longer resets when PAR_MA_FUNCTION (P201) is written to. mA trims (P214, P215) now have the property no Reset.</li> <li>• Enhancement: Device Identification command allows Tag, Description, Message, and Date.</li> </ul>
1.09	Nov. 28, 2005	<ul style="list-style-type: none"> <li>• Correction for manual Shaper TVT shift due to change in velocity.</li> <li>• Resolved issue of reading some floats as decimal shifted integers.</li> <li>• The submergence algorithm now implemented with the thresholds defined.</li> <li>• Changes to support single DUART.</li> </ul>
1.10	not released	
1.11	Apr. 20, 2006	<ul style="list-style-type: none"> <li>• Software modified to support replacement component.</li> <li>• Supports SIMATIC PDM version 6.02.</li> <li>• Added support for true First echo processing algorithm</li> <li>• Support for 3rd Point Volume has been added on P001 = DPA or DPD.</li> </ul>
1.12	Aug. 15, 2008	<ul style="list-style-type: none"> <li>• Many parameter ranges improved to match product function and SIMATIC PDM.</li> <li>• P110 = OFF removed from SIMATIC PDM</li> <li>• Improved text labels for P770</li> </ul>

# MultiRanger 200

Software Rev.	Date	Changes
1.00	Nov. 09, 2001	<ul style="list-style-type: none"> <li>• Pilot Release.</li> </ul>
1.01	Dec. 02, 2001	<ul style="list-style-type: none"> <li>• Initial Release.</li> </ul>
1.02	Aug. 20, 2002	<ul style="list-style-type: none"> <li>• P602 functions reduced point limit from 10 to 6.</li> <li>• Changed P132 to global.</li> <li>• P640 now accepts negative values.</li> <li>• Changed access mode of dialer parameters so they cannot be scrolled.</li> <li>• Clarified return message for factory RS232 test.</li> <li>• Prevent entering strings with invalid fields in Dolphin Plus.</li> <li>• Properly convert ft/sec to m/sec in P654.</li> <li>• Eliminated rogue watchdog resets when repeatedly pressing hand programmer enter while in P901-P903.</li> <li>• Allow 32 bit read/write as seconds.</li> <li>• Factory mode lock is written to flash.</li> <li>• Cleaned up compiler errors and Lint warnings.</li> <li>• Modified handling of non-quick start parameters.</li> <li>• Modifications for Production Testing.</li> <li>• Users may now configure the SmartLinx memory map.</li> <li>• Improved Preset Application values.</li> </ul>
1.03	Sept. 25, 2002	<ul style="list-style-type: none"> <li>• Allow files to be downloaded to the product using Dolphin+.</li> </ul>

<b>Software Rev.</b>	<b>Date</b>	<b>Changes</b>
1.04 1.05	Feb. 11, 2003 Feb. 21, 2003	<ul style="list-style-type: none"> <li>• Product enhancements to eliminate relay chatter on software download.</li> <li>• Improved functionality of receiver saturation during calibration.</li> <li>• Added relay functionality thru P118 to coincide with manual.</li> <li>• Improved product security with addition of P069.</li> <li>• Backup level override behaviour improvement.</li> <li>• Improved mA control with P210 - P213.</li> <li>• Improved temperature calibration in factory mode.</li> <li>• Improved Production Testing support.</li> <li>• Improved reset behaviour.</li> <li>• Changed default mA trim values.</li> <li>• Improved functionality of downloading in Dolphin +.</li> </ul>
1.06	May 27, 2004	<ul style="list-style-type: none"> <li>• RCVR offset limits are no longer handled in the code.</li> </ul>
1.07	Aug. 30, 2004	<ul style="list-style-type: none"> <li>• OCM Time Units improvement.</li> <li>• Totalizer enhancement to prevent a rounding error putting the totalizer into an unstable "mode."</li> <li>• Totalizer - Access to totalizer in OCM mode from Modbus map (reg 41040).</li> <li>• P060, P005 Dependency removed.</li> <li>• Split Values - Parameters with the "xx:yy" format now being limited properly.</li> <li>• Temperature Spike - Temperature readings now being protected from other units' transmit pulse.</li> <li>• TVT Shift - A rounding error in the number of samples caused the TVT to shift position.</li> <li>• Auto False Echo Suppression - Device learns the shape of an empty tank to automatically suppress false echos.</li> <li>• SIMATIC PDM Compatability - Device uses Modbus to communicate with SIMATIC PDM. DDs required.</li> </ul>

Software Rev.	Date	Changes
1.08	Aug. 30, 2004	<ul style="list-style-type: none"> <li>• Improvements made as a result of Siemens systems testing:</li> <li>• SIMATIC PDM related: TVT display improvement to prevent it from going negative. MLFB number includes SMPI as well as Siemens numbering. Change of some enumerations in the Device Description.</li> <li>• Device related: mA output no longer resets when PAR_MA_FUNCTION (P201) is written to. mA trims (P214, P215) now have the property noReset.</li> <li>• Enhancement: Device Identification command allows Tag, Description, Message, and Date.</li> </ul>
1.09	Nov. 28, 2005	<ul style="list-style-type: none"> <li>• Correction for manual Shaper TVT shift due to change in velocity.</li> <li>• Reading some floats as decimal shifted integers would return a value off by 1 in some cases.</li> <li>• The submergence algorithm now implemented with the thresholds defined.</li> <li>• Changes to support single DUART.</li> </ul>
1.10	not released	
1.11	Apr. 20, 2006	<ul style="list-style-type: none"> <li>• Software modified to support replacement component.</li> <li>• Supports SIMATIC PDM version 6.02.</li> <li>• Added support for true First echo processing algorithm</li> <li>• Support for 3rd Point Volume has been added on P001 = DPA or DPD.</li> </ul>
1.12	Aug. 01, 2006	<ul style="list-style-type: none"> <li>• Internal Release.</li> </ul>
1.13	Aug. 15, 2008	<ul style="list-style-type: none"> <li>• Many parameter ranges improved to match product function and SIMATIC PDM.</li> <li>• P110 = OFF removed from SIMATIC PDM</li> <li>• Improved volume calculation for 3rd point volume</li> <li>• Improved text labels for P770</li> </ul>
1.16	Nov 28, 2017	<ul style="list-style-type: none"> <li>• Removed battery</li> </ul>
1.18	Nov 14, 2019	<ul style="list-style-type: none"> <li>• Improved robustness of flash programming</li> </ul>

# Programming Charts

#	Parameter Name	Altered Values for Indices/Point Numbers		
		1	2	3
<b>Security</b>				
P000	Lock (G)			
<b>Quickstart</b>				
P001	Operation			
P002	Material			
P003	Max. Process Speed			
P004	Transducer			
P005	Units (G)			
P006	Empty			
P007	Span			
<b>Volume</b>				
P050	Tank Shape			
P051	Max Volume			
P052	Tank Dimension A			
P053	Tank Dimension L			
P054	Level Breakpoints		record values on a separate sheet.	
P055	Volume Breakpoints		record values on a separate sheet.	
<b>Reading Value</b>				
P060	Decimal Position			
P061	Convert Reading			
P062	Offset Reading			
P064	Reading Override Enable			
P065	Reading Override Value			
P066	Override Time Delay			
P069	Password			
<b>Failsafe</b>				
P070	Failsafe Timer			
P071	Failsafe Material Level			
P072	Failsafe Level Advance			
<b>Relays</b>				
P100	Preset Applications [MR200]			
P110	Level Source			
P111	Relay Control Function			
P112	Relay ON Setpoint			

<b>Parameter</b>		<b>Altered Values for Indices/Point Numbers</b>		
<b>#</b>	<b>Name</b>	<b>1</b>	<b>2</b>	<b>3</b>
P113	Relay OFF Setpoint			
P115	Relay Interval Setpoint [MR 200]			
P116	Deadband			
P118	Relay Output Logic			
P119	Relay Logic Test			
<b>Pump Setpoint Modifiers</b>				
P121	Pump by Rate [MR 200]			
P122	Pump Service Ratio [MR 200]			
<b>Independent Relay Failsafe</b>				
P129	Relay Failsafe			
<b>Advanced Pump Control Modifiers</b>				
P130	Pump Run-On Interval [MR 200]			
P131	Pump Run-On Duration [MR 200]			
P132	Pump Start Delay [MR 200]			
P133	Pump Power Resumption Delay [MR 200]			
P136	Wall Cling Reduction [MR 200]			
P137	Pump Group [MR 200]			
<b>Flush Systems</b>				
P170	Flush Pump [MR 200]			
P171	Flush Cycles [MR 200]			
P172	Flush Interval [MR 200]			
P173	Flush Duration [MR 200]			
<b>mA Output</b>				
P200	mA Output Range			
P201	mA Output Function			
P202	mA Output Allocation			
P203	mA Output Value / Transducer			
<b>Independent mA Setpoints</b>				
P210	0/4 mA Output Setpoint			
P211	20 mA Output Setpoint			
<b>mA Output Limits</b>				
P212	mA Output Min Limit			
P213	mA Output Max limit			
<b>mA Output Trim</b>				
P214	4 mA Output Trim			
P215	20 mA Output Trim			

<b>Parameter</b>		<b>Altered Values for Indices/Point Numbers</b>		
<b>#</b>	<b>Name</b>	<b>1</b>	<b>2</b>	<b>3</b>
P219	mA Output Failsafe[MR 200]			
<b>mA Input</b>				
P250	mA Input Range [MR 200]			
P251	0 to 4 mA Input Level [MR 200]			
P252	20 mA Input Level [MR 200]			
P253	Input Filter Time Constant [MR 200]			
P254	Scaled mA Input Value[MR 200]			
P260	mA Raw Input [MR 200]			
<b>Discrete Input Functions</b>				
P270	Discrete Input Function			
P275	Scaled Discrete Input Value			
<b>Record Temperatures</b>				
P300	Temp, Transducer max			
P301	Temp, Transducer min			
P302	Temperature, Sensor max			
P303	Temperature, Sensor min			
<b>Record Readings</b>				
P304	Reading Max			
P305	Reading Min			
<b>Pump Records</b>				
P309	Pump RUN Time			
P310	Pump Hours			
P311	Pump Starts			
P312	Pump Run Ons [MR 200]			
<b>Flow Records</b>				
P320	Flow Max [MR 200]			
P321	Flow Min [MR 200]			
<b>LCD Totalizer</b>				
P322	LCD Total Low [MR 200]			
P323	LCD Total High [MR 200]			
<b>Profile Records</b>				
P330	Profile Record			
P331	Auto Record Enable			
P332	Auto Record Transducer			
P333	Auto Record Interval			
<b>Auto Record ON and OFF Setpoints</b>				

<b>Parameter</b>		<b>Altered Values for Indices/Point Numbers</b>		
<b>#</b>	<b>Name</b>	<b>1</b>	<b>2</b>	<b>3</b>
P334	Auto Record ON Setpoint			
P335	Auto Record OFF Setpoint			
P336	Auto Record Filling/Emptying			
P337	Auto Record LOE Time			
<b>Installation Records</b>				
P340	Date of Manufacture			
P341	RUN Time			
P342	Start Ups			
<b>Open Channel Monitoring</b>				
P600	Primary Measuring Device [MR 200]			
P601	Flow Exponent [MR 200]			
P602	Primary Measuring Device Dimensions [MR200]			
P603	Maximum Head [MR 200]			
P604	Maximum Flow [MR 200]			
P605	Zero Head [MR 200]			
P606	Time Units [MR 200]			
P607	Flowrate Decimal [MR 200]			
P608	Flowrate Units [MR 200]			
P610	Head Breakpoints [MR 200]			
P611	Breakpoint Flowrates [MR 200]			
P620	Low Flow Cutoff [MR 200]			
P621	Auto Zero Head [MR 200]			
<b>Pumped Volume Totalizer</b>				
P622	Inflow / Discharge Adjust [MR 200]			
<b>Totalizer</b>				
P630	LCD Totalized Multiplier [MR 200]			
P633	LCD Totalized Decimal Postion [MR 200]			
P640	Remote Totalized Multiplier [MR 200]			
P641	Flow Sampler Mantissa [MR 200]			
P642	Flow Sampler Exponent [MR 200]			
P645	Relay Duration [MR 200]			



Parameter		Altered Values for Indices/Point Numbers		
#	Name	1	2	3
<b>Range Calibration</b>				
P650	Offset Calibration			
P651	Sound Velocity Calibration			
P652	Offset Correction			
P653	Velocity			
P654	Velocity @ 20° C			
<b>Temperature Compensation</b>				
P660	Temp Source			
P661	Temp Fixed			
P663	Temp Transducer Allocation			
P664	Temperature			
<b>Rate</b>				
P700	Max Fill Rate			
P701	Max Empty Rate			
P702	Filling Indicator			
P703	Emptying Indicator			
P704	Rate Filter			
P705	Rate Update Time			
P706	Rate Update Distance			
P707	Rate Value			
P708	Volume Rate Display [MR 200]			
<b>Measurement Verification</b>				
P710	Fuzz Filter			
P711	Echo Lock			
P712	Echo Lock Sampling			
P713	Echo Lock Window			
<b>Transducer Scanning</b>				
P726	Level System Sync			
P727	Scan Delay			
P728	Shot Delay			
P729	Scan Time			
<b>Display</b>				
P730	Auxiliary Reading			
P731	Auxiliary Reading Key			
P732	Display Delay			
P733	Scroll Access			
P735	Backlight			

<b>Parameter</b>		<b>Altered Values for Indices/Point Numbers</b>		
<b>#</b>	<b>Name</b>	<b>1</b>	<b>2</b>	<b>3</b>
P737	Primary Reading [MR 200]			
P741	Communications Timeout			
<b>SmartLinX Reserved</b>				
<b>Communications</b>				
P770	Port Protocol			
P771	Network Address			
P772	Baud Rate			
P773	Parity			
P774	Data Bits			
P775	Stop Bits			
P778	Modem Available			
P779	Modem Inactivity Timeout			
P782	Parameter Index Location			
<b>SmartLinX Hardware Testing</b>				
P790	Hardware Error			
P791	Hardware Error Code			
P792	Hardware Error Count			
P794	SmartLinX Module Type			
P795	SmartLinX Protocol			
P799	Communications Control			
<b>Echo Processing</b>				
P800	Near Blanking			
P801	Range Extension			
P802	Transducer with Submergence Shield			
P803	Shot / Pulse Mode			
P804	Confidence Threshold			
P805	Echo Confidence			
P806	Echo Strength			
P807	Noise			
<b>Advanced Echo Processing</b>				
P815	Echo Time Filtered			
P816	Echo Time Raw			
P820	Algorithm			
P821	Spike Filter			
P822	Narrow Echo Filter			
P823	Reform Echo			

<b>Parameter</b>		<b>Altered Values for Indices/Point Numbers</b>		
<b>#</b>	<b>Name</b>	<b>1</b>	<b>2</b>	<b>3</b>
P824	(reserved)			
P825	Echo Marker Trigger			
<b>Advanced TVT Adjustment</b>				
P830	TVT Type			
P831	TVT Shaper			
P832	TVT Shaper Adjust			
P833	TVT Start Min			
P834	TVT Start Duration			
P835	TVT Slope Min			
P837	Auto-False Echo Suppression			
P838	Auto-False Echo SuppressionDistance			
P839	TVT Hover Level			
<b>Advanced Shot Adjustment</b>				
P840	Short Shot Number			
P841	Long Shot Number			
P842	Short Shot Frequency			
P843	Long Shot Frequency			
P844	Short Shot Width			
P845	Long Shot Width			
P850	Short Shot Bias			
P851	Short Shot Floor			
P852	Short Shot Range			
P900	Software Revision Number			
P901	Memory			
P902	Watchdog			
P903	Display			
P904	Keypad			
P905	Transmit Pulse			
P906	RS-232 Port			
P908	Scanner			
P910	Toggle Relays			
P911	mA Output Value			
P912	Transducer Temperature			
P913	Sensor Temperature			
P914	mA Input [MR 200]			
<b>Measurement</b>				

<b>Parameter</b>		<b>Altered Values for Indices/Point Numbers</b>		
<b>#</b>	<b>Name</b>	<b>1</b>	<b>2</b>	<b>3</b>
P920	Reading Measurement			
P921	Material Measurement			
P922	Space Measurement			
P923	Distance Measurement			
P924	Volume Measurement [MR 200]			
P925	Flow Measurement [MR 200]			
P926	Head Measurement [MR 200]			
P927	Distance Measurement			
P999	Master Reset			

# Index

## A

accuracy .....	4
adding new functions .....	245
alarm .....	54
bounded .....	56
cable fault .....	56
common parameters .....	54
emptying rate .....	55
filling rate .....	55
level .....	54
loss of echo .....	57
rate .....	55
temperature .....	56
alternate duty assist .....	241
alternate duty backup .....	59, 60, 61, 241
alternate duty service .....	62
application .....	
test .....	87
applications .....	
preset .....	46
testing .....	85
approvals .....	6
auxiliary reading .....	25

## B

backup level override .....	47
battery .....	13
bit values .....	107
blanking .....	
troubleshooting .....	236
with Span .....	123
board .....	13

## C

cable .....	16
routing .....	9
cabling guidelines .....	92
calibration .....	
mA output .....	49
characterization chart .....	52
communication ports .....	
configuring .....	94
communications .....	89
communications installation .....	92
configuration .....	2
control .....	
rake .....	69
controlling the display .....	25

## D

data types .....	107
bit values .....	107
default auxiliary reading .....	26
dimensions .....	9, 40
discrete inputs .....	48, 100
indexing .....	36
logic .....	48
wiring .....	48
display .....	4
auxiliary .....	25
controlling .....	25
distance .....	23
echo confidence .....	23
failsafe time left .....	23
head (OCM) .....	23
multiple readings .....	26
pump hours .....	23
rate of change .....	23
temperature .....	23
display readout .....	34
distance calculation .....	226
Dolphin Plus .....	29, 35, 89
changing parameters .....	35
communication settings .....	91
updating software .....	245

## E

echo confidence, run mode .....	23
echo processing .....	224
enabling new functions .....	245
enclosure .....	6
error codes .....	34, 116
error handling .....	111
exponential flow .....	79
external totalizers .....	71

## F

failsafe .....	40
by relay .....	45
fat ring .....	66
first in first out (FIFO) .....	62, 243
fixed duty assist .....	61
flash update .....	245
flow calculation .....	228
flow sampler .....	72
flume .....	
cut throat .....	82
H flume .....	78

Leopold Lagco .....	81	single point .....	38
Palmer Bowlus .....	77	starting .....	38
Parshall .....	80, 84	Modbus .....	90
rectangular .....	76	register map .....	97
universal trapezoidal .....	84	responses .....	111
flush valve .....	67	mode .....	
format words .....	105	program .....	27
Frequency Input .....	153	run .....	22
<b>G</b>		mounting .....	
global index method .....	103	instructions .....	9
group pumps .....	67	location .....	8
<b>H</b>		wall mount .....	9
H flume .....	165	multiple readings .....	26
hand programmer .....	27	<b>N</b>	
head measurement .....	23	near blanking .....	
head vs. flowrate breakpoints .....	172	troubleshooting .....	236
<b>I</b>		with span .....	123
in bounds .....	56	noise problems .....	232
independent failsafe .....	65	noise sources .....	233
index method .....		<b>O</b>	
global .....	103	OCM (open channel monitoring) .....	73
parameter specific .....	103	common parameters .....	73
index types .....	118, 223	cut throat .....	82
indexed parameters .....	37	flow characterization chart .....	83
indexing .....		flow exponent support .....	79
parameters .....	36	H flume .....	78
points .....	36	Leopold Lagco flume .....	81
input / output .....	99	Palmer Bowlus flume .....	77
inputs .....	6	Parshall flume .....	80
installation .....	8	rectangular flume .....	76
<b>L</b>		testing flow values .....	86
LCD controlling .....	25	totalized volume .....	75
level alarms .....	54	universal calculation .....	83
LOE .....	57	universal Parshall flume .....	84
loss of echo (LOE) .....	40	universal trapezoidal flume .....	84
alarm .....	57	V notch weir .....	75
<b>M</b>		weirs .....	79
mA .....		zero head .....	74
calibrating .....	49	operation .....	
input .....	49	dual point .....	39
loops .....	49	single point .....	38
output .....	49, 50	options, adding .....	245
map ID .....	98	out of bounds .....	56
maximum process speed .....	230	outputs .....	5
maximum separation .....	92	<b>P</b>	
measurement .....		parameter .....	
difficulties .....	234	relays .....	43
dual point .....	39	parameter access .....	
set up .....	38	data types .....	107
setting up .....	38	format words .....	105

overview .....	102	totalizer .....	175
reading .....	103	transducer scanning .....	190
writing .....	104	view only .....	33
parameter indexing .....	36, 102	volume .....	123
parameters		volume measurement .....	220
advanced echo processing .....	203	points	
advanced shot adjustment .....	212	indexing .....	36
advanced TVT adjustment .....	207	ports, communication .....	90
auto record setpoints .....	162	power .....	19
backup level override .....	129	preprogrammed applications .....	46
calibration .....	178	program mode .....	27
communications .....	194	programming .....	4
data logging .....	154	alarms .....	54
discrete input functions .....	153	by hand .....	27
display .....	191	relays .....	41
display and reading .....	127	pump	
echo processing .....	199	alternate duty backup .....	59, 60
failsafe .....	131	by rate .....	63
flow records .....	158	hours .....	23
flush systems .....	144	off setpoint .....	59, 60, 61
global .....	33	on setpoints .....	59, 60, 61
independent mA setpoints .....	149	other controls .....	61
independent relay failsafe .....	140	pump down .....	58
installation records .....	164	pump up .....	59
LCD totalizer .....	158	reservoir .....	59
mA input .....	151	run-on .....	66
mA output .....	146	service ratio .....	64
mA output failsafe .....	151	start delay .....	66
mA output limits .....	149	start method .....	239
mA output trim .....	150	totalizing volume .....	65
master reset .....	221	usage .....	68
measurement .....	218	wet well .....	58
measurement verification .....	187	pump by rate .....	243
open channel monitoring (OCM) ..	165	pump control .....	100
profile records .....	159	algorithms .....	58, 239
pump control modifiers .....	141	options .....	239
pump records .....	156	other .....	243
pump setpoint modifiers .....	139	reference .....	239
pumped volume totalizer .....	174	pump flush valve .....	67
quick start .....	119	pump hours .....	101
rate .....	183	pump starts .....	101
record readings .....	156	<b>Q</b>	
record temperatures .....	154	quick start .....	38
relays .....	132	<b>R</b>	
scrolling .....	32	rake control .....	69
SmartLinx hardware testing .....	197	randomize setpoints .....	66
SmartLinx reserved .....	194	range .....	4
special .....	33	reading	
status .....	24	volume .....	51
temperature compensation .....	181	recording profiles .....	160
test .....	215		

register map .....	97	single parameter access .....	114
discrete inputs .....	100	single point .....	38
input/output .....	99	SmartLinx .....	91
mA output .....	100	installation .....	14
map ID .....	98	Installation in Wall mount .....	14
parameter access .....	102	software update .....	245
parameter format words .....	105	sound velocity .....	226
point data .....	99	special parameters .....	33
product ID .....	99	specific auxiliary reading .....	26
pump control .....	100	specifications .....	3
pump hours .....	101	standard applications .....	46
pump setpoint .....	100, 101	start delay .....	66
pump starts .....	101	starting measurement .....	38
pumped volume .....	101	status parameters .....	24
relay outputs .....	100	synchronization .....	19
UINT32 Order .....	98	<b>T</b>	
relay .....	17	tank shape .....	51
activation .....	44	temperature	
failsafe .....	45	alarm .....	56
flow sampler .....	72	compensation .....	4
function codes .....	110	error .....	4
indexing .....	36	run mode .....	23
modifiers .....	43	sensor .....	18
modify logic .....	45	terminal board .....	16
outputs .....	100	testing	
parameters .....	43	application .....	87
programming .....	41	configuration .....	85
totalizer .....	71	text messages .....	109
wiring test .....	44	totalizer .....	71
resolution .....	4	transducers .....	6, 17
response rate .....	40	indexing .....	36
RS-232 .....	20	transmit pulse .....	224
RS-485 .....	20	troubleshooting	
run mode .....	22	common problems .....	231
run-on .....	66	communication .....	113
<b>S</b>		noise problems .....	232
samplers .....	71	TS-3 .....	18
SCADA .....	89	<b>U</b>	
scrolling parameters .....	32	UINT32 .....	107
scum ring See wall cling .....	66	units or percent .....	33
security .....	33	universal	
service ratio		example .....	52
applications .....	64	volume .....	52
duty assist .....	242	unsigned double precision integer .....	107
duty backup .....	243	updating software .....	245
simulation .....	85	<b>V</b>	
level cycle .....	85	verify	
OCM flow characterization .....	86	mA output .....	50
single measurement .....	85	volume .....	51
volume characterization .....	86	calculation .....	227



characterization chart .....	52
dimensions .....	40
readings .....	51
tank shape .....	51
universal example .....	52
<b>W</b>	
wall cling .....	66
weight .....	6
weir	
Cipolletti .....	167
standard .....	79
V notch .....	75
wet well .....	58
wiring .....	15
communication .....	92
problems .....	233
test .....	44
writing parameters .....	104
wrong reading .....	236

## For more information

[www.siemens.com/level](http://www.siemens.com/level)

[www.siemens.com/weighing](http://www.siemens.com/weighing)

Siemens Canada Limited  
1954 Technology Drive  
P.O. Box 4225  
Peterborough, ON  
Canada K9J 7B1

Subject to change without prior notice  
7ML19985FB06, rev 6.2  
© Siemens AG 2019



Printed in Canada

[www.siemens.com/processautomation](http://www.siemens.com/processautomation)