



**Concentration Meters
MicroPolar (++)
LB 566**

**User's Guide
Hardware Manual
41986BA2**

Rev. Nr.: 07, 03/2018

The units supplied should not be repaired by anyone other than Berthold Technologies Service engineers or technicians by Berthold Technologies.

In case of operation trouble, please address to our central service department (address see below).

The complete user's guide consists of the hardware manual and the software manual.

The **hardware manual** comprises:

- mechanical components
- installation
- electrical installation
- technical data
- electrical and mechanical drawings

The **software manual** comprises:

- operation of the evaluation unit
- parameter description
- basic setup
- calibration
- error messages

The present manual is the hardware description.

Subject to change without prior notice.

BERTHOLD TECHNOLOGIES GmbH & Co. KG	
Calmbacher Str. 22 · D-75323 Bad Wildbad	
Switchboard:	Service:
Phone +49 7081 177 0	Phone +49 7081 177 111
Fax +49 7081 177 100	Fax +49 7081 177 339
industry@Berthold.com	Service@Berthold.com
www.Berthold.com	

Table of Contents

	Page
Chapter 1. Safety Summary	7
1.1 Symbols and Warnings	7
1.2 General Information	8
1.3 General Safety Instructions	9
Chapter 2. General Information	11
2.1 Use and Function	11
2.2 Frequency License	12
2.3 Intended Use	14
2.4 Explanation of Terms	15
Chapter 3. System Description	17
3.1 Principle of Measurement	17
3.2 Calculation of Measured Values	18
3.3 Temperature Compensation	19
3.4 Throughput Calculation and Output	20
3.5 Mechanical Components	21
3.5.1 Evaluation Units	23
3.5.2 FlowCell	25
3.5.3 Container Probe	28
3.5.4 High-frequency Cable	31
3.6 Assembly on a Pipeline	33
3.7 Assembly on a Container	34
Chapter 4. Getting Started	35
4.1 Transport	35
4.2 Commissioning the FlowCell	36
4.2.1 Installing the FlowCell	36
4.2.2 Installing the Evaluation Unit	38
4.2.3 Connecting the HF Cable	39
4.3 Commissioning the Container Probe	41
4.3.1 Installing the Container Probe	41
4.3.2 Setting Up the Evaluation Unit	43
4.3.3 Connecting the HF Cable	43
4.5 Connecting the Evaluation Unit	45
4.5.1 Pin Configuration of the Connector Strip	46
4.5.2 Digital Outputs, Relay	48
Chapter 5. Service instructions	51
5.1 General Information	51
5.2 Wear Parts	52
5.3 Instrument Cleaning	54
5.4 Battery	54
5.5 Fuse Replacement	55

Chapter 6. Technical Data	57
6.1 Technical Data Evaluation Unit	57
6.2 Technical Data Sensors	60
6.3 Technical Data HF Cable	65
6.4 Format of Serial Data Output RS232 and RS485	67
Chapter 7. Certificates	69
7.1 EC Declaration of Conformity	69
7.2 Frequency License	72
Chapter 8. Technical Drawings	81
8.1 Dimensions Drawings Evaluation Unit Wall Housing	81
8.2 Electrical Wiring Diagram	83
8.3 Dimensional Drawings FlowCell	84
8.3.1 Type LB 5660-102-00X FlowCell DN 50 Flange, FDA	84
8.3.2 Type LB 5660-202-00X FlowCell DN 65 Flange, FDA	85
8.3.3 Type LB 5660-302-00X FlowCell DN 80 Flange, FDA	86
8.3.4 Type LB 5660-402-00X FlowCell DN 100 Flange, FDA	87
8.3.5 Type LB 5660-502-00X FlowCell DN 125 Flange, FDA	88
8.3.6 Type LB 5660-602-00X FlowCell DN 150 Flange, FDA	89
8.3.7 Type LB 5660-112-00X FlowCell DN 50 G-BS/M	90
8.3.8 Type LB 5660-212-00X FlowCell DN 65 G-BS/M	91
8.3.9 Type LB 5660-312-00X FlowCell DN 80 G-BS/M	92
8.3.10 Type LB 5660-412-00X FlowCell DN 100 G-BS/M	93
8.3.11 Type LB 5660-512-00X FlowCell DN 125 G-BS/M	94
8.3.12 Type LB 5660-612-00X FlowCell DN 150 G-BS/M	95
8.4 Dimensional Drawings Container Probes	96
8.4.1 Type LB 5650-01	96
8.4.2 Type LB 5650-02	97
8.4.3 Type LB 5650-03	98
8.4.4 Type LB 5650-04	99
8.4.5 Type LB 5650-05	100
8.4.6 Type LB 5650-09	101
8.4.7 Installation Situation in Pipelines	102
8.5 Dimensional Drawings Container Flush Probes	103
8.5.1 Type LB 5651-01	103
8.5.2 Type LB 5651-02	104
8.5.3 Type LB 5651-03	105
8.5.4 Type LB 5651-04	106
8.5.5 Type LB 5651-05	107
8.5.6 Installation Situation in Pipelines	108
8.6 Assembly sheets for LB 5650 (Container probe)	109
8.1 Assembly sheets for LB 5651 (Container flush probe)	111

Chapter 1. Safety Summary

1.1 Symbols and Warnings

In this user manual, the term Berthold Technologies stands for the company Berthold Technologies GmbH & Co.KG.

To rule out bodily injury and property damage, please keep in mind the warning and safety instructions provided in this user manual. They are identified by the following signs: DANGER, WARNING, CAUTION or NOTICE.



Indicates imminent danger. If it cannot be avoided, death or most severe personal injuries may be the consequence.



Indicates a possibly dangerous situation. The consequences may be death or most severe personal injuries.



Indicates a possibly harmful situation. The consequences may be minor or medium personal injuries.



Indicates a situation that may cause material damage if the instructions are not followed.



Paragraphs with this symbol provide important information on the product and how to handle it.



Contains user tips and other useful information.

Other symbols used in this documentation:



Warning: No intervention, do not alter anything



Requirement: Disconnect power



Requirement: Wear safety boots

1.2 General Information

The most important safety measures are summarized in this user manual. They supplement the corresponding regulations which *must* be studied by the personnel in charge.

Please pay attention to:

- the national safety and accident prevention regulations
- the national assembly and installation directions
- the generally recognized engineering rules
- the information on transport, assembly, operation, service, maintenance
- the safety instructions and information in these operating instructions
- the enclosed technical drawings and wiring diagrams
- the characteristic values, limit values and the information on operating and ambient conditions on the type labels and in the data sheets
- the signs on the devices
- the country-specific licensing schemes

1.3 General Safety Instructions

i IMPORTANT

The equipment housings have IP 65 protection and are suitable for outdoor applications. The units are factory tested and are delivered in a condition that permits safe and reliable operation.

NOTICE

For outdoor applications, the measuring systems must be protected from direct sunlight and rain, for example by a suitable shelter.

i IMPORTANT

Never change the installation and the parameter settings without a full knowledge of these operating instructions, as well as a full knowledge of the behavior of the connected controller and the possible impact on the operating process to be controlled.

NOTICE

The systems may only be used in perfect technical condition and only for the intended use!

⚠ CAUTION

Only let persons work with the systems who are mandated to do this and are suitably qualified and adequately trained! Installations and modifications on the systems which may affect the operational safety are not permitted!

Ambient conditions

i IMPORTANT

All system components require non-corrosive ambient conditions during transport, storage and operation.

i IMPORTANT

If liquid gets inside the instrument, cut off the power supply. The equipment must be inspected and cleaned by an authorized service center.

⚠ WARNING

Electrical hazards

Disconnect power to ensure that contact with live part is avoided during installation and when servicing.

Disconnect the power supply before opening the instrument. Work on open and live instruments is prohibited.

NOTICE

Caution! Potential hazards, material damage!

Device type:

LB 566-12 MicroPolar ++ (ID no. 51833-02)

When connecting the 24 V DC power supply, the + and – poles must be connected correctly. There is no reverse polarity protection!

NOTICE

Spare fuses must match the rating specified by the device manufacturer. Short-circuiting or manipulation is not permitted.

i IMPORTANT

The LB 566 and all additional equipment must be connected to mains via grounded connection.

i IMPORTANT

The concentration meter LB 566 may be installed, serviced and repaired only by qualified specialists.

Qualified persons

Qualified specialists are persons who through professional training have acquired sufficient skills in the respective field and who are familiar with the relevant national industrial safety regulations, accident prevention directions, guidelines and accepted engineering standards. They must be able to safely assess the results of their work and they must be familiar with the contents of these user manual.

Chapter 2. General Information

2.1 Use and Function

The MicroPolar LB 566 has been designed as a concentration measuring system and may be used only for this purpose. If the devices are used in a manner that are not described in this user manual, the protection of the devices is compromised and the warranty will be lost.

Berthold Technologies is liable and guarantees only that the devices comply with its published specifications. The LB 566 may only be installed in an undamaged, dry and clean condition. Alterations and modifications to the system components are not permitted.

The LB 566 is not qualified as a "safety-related measurement".

Conformity to standards

The standards and guidelines the LB 566 complies with are itemized in these device instructions in *chapter 2.2 Frequency License* and *chapter 7.1 EC Declaration of Conformity*.

Pressure equipment directive

The FlowCell and the container probe has been classified as pressure equipment acc. to art. 4 sect. 3 of guideline 2014/68/EU. Before use, check whether the case of use corresponds to this classification. In particular, the media compatibility of the components in contact with the fluid must be checked.

Protection type

The protection type of the LB 566 to IEC 60529 is max. IP 65.

Warning against misuse

The following use is inappropriate and has to be prevented:

- The use under conditions other than the terms and conditions stated by the manufacturer in their technical documentation, data sheets, operating and installation manuals and other specifications.
- The use after repair by persons not authorized by Berthold Technologies.
- The use in a damaged or corroded state.
- Operation with open or inadequately closed cover.
- Operating with insufficiently tightened adapters and cable glands.
- Operation without the manufacturer's recommended safety precautions.
- Manipulating or bypassing existing safety facilities.

Authorized persons

Authorized persons are those who, by law, are permitted to perform the respective activity, or who have been approved by Berthold Technologies for certain activities.

2.2 Frequency License

This device complies with Part 15 of the FCC Rules and with Industry Canada licence-exempt RSS standard(s).

Operation is subject to the following two conditions:

- (1) this device may not cause harmful interference, and
- (2) this device must accept any interference received, including interference that may cause undesired operation.

Le présent appareil est conforme aux CNR d'Industrie Canada applicables aux appareils radio exempts de licence.

L'exploitation est autorisée aux deux conditions suivantes:

- (1) l'appareil ne doit pas produire de brouillage, et
- (2) l'appareil doit accepter tout brouillage radioélectrique subi, même si le brouillage est susceptible d'en compromettre le fonctionnement.

License labels

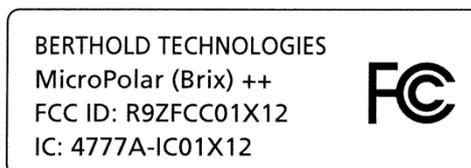
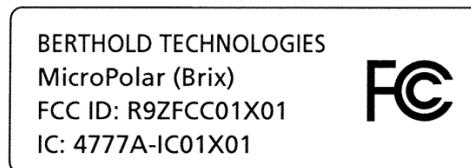

This equipment has been tested and found to comply with the limits for a Class B digital device, pursuant to part 15 of the FCC Rules. These limits are designed to provide reasonable protection against harmful interference in a residential installation. This equipment generates, uses and can radiate radio frequency energy and, if not installed and used in accordance with the instructions, may cause harmful interference to radio communications. However, there is no guarantee that interference will not occur in a particular installation. If this equipment does cause harmful interference to radio or television reception, which can be determined by turning the equipment off and on, the user is encouraged to try to correct the interference by one or more of the following measures:

- Reorient or relocate the receiving antenna.
- Increase the separation between the equipment and receiver.

- Connect the equipment into an outlet on a circuit different from that to which the receiver is connected.
- Consult the dealer or an experienced radio/TV technician for help.

Changes or modifications made to this equipment not expressly approved by BERTHOLD TECHNOLOGIES may void the FCC authorization to operate this equipment.

The MicroPolar and MicroPolar ++ comply with the R&TTE Directive 1999/5/EC and thus meet all the requirements for this type of high-frequency devices. As a mark of conformity in accordance with the CE mark, the devices bear the no. 0682 of the certification body. The certificate can be found in *chapter 7.3 Frequency License*.

CE 0682

i IMPORTANT

The frequency approvals and conformities are only applicable in combination with the container probes and the FlowCell.

To comply with ETSI (European Telecommunications Standards Institute), the LB 566 ++ in combination with horn and spiral antennae may only be operated with a 10dB attenuator pad in the sending path (MTX).

i IMPORTANT

The LB 566 has been manufactured in compliance with the safety requirements for microwave devices. It will be the user's responsibility to adhere to any special legal provisions regarding the use of microwaves.

i IMPORTANT

Any change in the frequency or otherwise tampering with the microwave device will lead to a loss of the frequency license and may result in criminal consequences.

The microwave modules do not include any replaceable components and must not be opened.

2.3 Intended Use

The LB 566 can be used to determine the water or moisture content and the concentration of virtually any material. The following sensors and evaluation versions are available:

1. The container probes have been designed for installation into containers and pipelines with a nominal width of ≥ 200 mm. The probe is mounted so that both measuring rods (transmitter and receiver) are immersed into the product being measured.
2. The The flow cell is a tubular probe that is either installed into the existing pipeline system inline or into a bypass.

The evaluation unit is available in two versions: The standard model MicroPolar and the high dynamic version MicroPolar ++. The Micro Polar ++ requires a microwave signal attenuation of at least 40 dB. The MicroPolar must be used for lower microwave attenuation.

During operation, the concentration meters MicroPolar and MicroPolar ++ emit electromagnetic radiation in the frequency range between 2.4 GHz and 2.5 GHz (range limitations depending on local regulations in your country). Microwaves are not dangerous to human beings and the environment (power radiation < 10 mW). The microwaves are emitted directed from the microwave window; the product is not altered by the microwaves.

To ensure proper function of the measuring system, please pay attention to the following:



TIP

- The material to be measured may be electrically conductive only to a limited degree.
 - The product must not contain any gas bubbles or gas bubbles have to be compressed with adequate pressure when carrying out measurements in pipelines.
 - The ion concentration, for example, salt content must be nearly constant.
-

2.4 Explanation of Terms

Attenuation	Weakening of microwave signals, microwaves measuring effect.
EVU	E valuation U nit
Factory setting	In the factory setting all parameters have been set to default values. In most cases this considerably facilitates the calibration of the instrument. Despite factory setting, calibration al-ways has to be performed.
FlowCell	Tubular probe for simple integration into the existing pipeline system.
Flush probe	Container probe with flushing device.
HF cable	H igh f requency cable
Microwaves	Designation for electromagnetic waves in a specific frequency range.
Phase	Phase or phase shift, microwave measuring effect.
Quad cable	Combination of four HF cables of equal length in a corrugated tube.
Softkeys	Software associated keys.
TC	T emperature c ompensation

Chapter 3. System Description

3.1 Principle of Measurement

As the microwaves pass through the product, their propagation velocity is slowed down (= phase shift) and their intensity is attenuated (= attenuation). Figure 3-1 illustrates the principle of measurement: Compared to a reference signal, the propagation velocity of microwaves passing through the product is slowed down (phase shift) and their intensity (attenuation) is reduced.

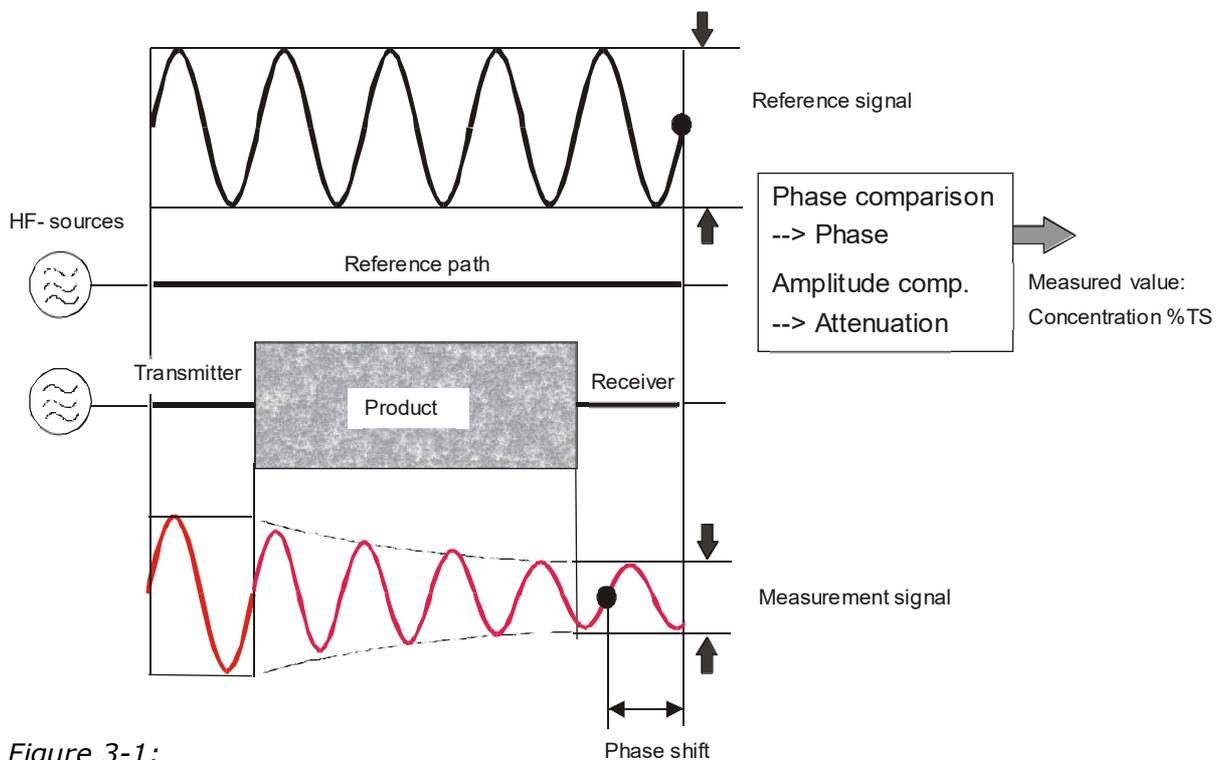

Figure 3-1:
Schematic diagram:
Change in
microwave by
product

The prerequisite is that the product being measured shows dielectric properties. Generally, water is a very distinct dielectric fluid. The water or dry mass concentration can therefore be determined by measuring the phase shift and/or attenuation.

The concentration to be detected in the product is therefore in good approximation linearly dependent on the phase shift and the attenuation. For this reason, we can measure the concentration or the dry matter content of the product using a linear calibration (see chapter 3.2 Calculation of Measured Values).

3.2 Calculation of Measured Values

The microwave parameters phase and attenuation are calibrated according to an automatic plausibility analysis.

During calibration, the phase and/or attenuation of a concentration value (or density value) are assigned through sampling. The calibration is done automatically and the sampling process is supported by the evaluation unit.

Which of the parameters (phase, attenuation or both) will be used for the calibration depends on the size and interference of the measuring effect. For example, the attenuation is significantly more sensitive to electrolytic conductivity (salt content).

In many cases, the pure phase measurement is recommended and the measured value is calculated as follows:

$$\text{Measured value} = A \cdot \text{Phase} + C \quad \text{Eq. 3-1}$$

where:

Measured value	Concentration / Moisture / Dry matter
A, C	Coefficients of the respective calibration function

The LB 566 allows you to calibrate, display and output two concentrations: Con1 and Con2. You have to enter the calibration coefficients separately for concentration 1 and 2. For more information please refer to the Software Manual.

Limitations

- Weakly bound water can be detected depending on the strength of the binding. Thus, the measuring effect may be dependent on the grain size distribution and the chemical properties of the product being measured, provided this changes the binding of water to the solid matter.
- Walls made of plastic, rubber or insulation materials with fairly low dielectricity hardly affect the measurement and are calibrated at a constant level.
- Ice and crystal water cannot be measured because the water molecules cannot rotate freely (ice and crystal water are dry).

Conductive materials such as graphite or coke cannot be transmitted by microwaves. Metal walls can also not be transmitted by microwaves.

Compensation

In addition to the water content, the product temperature, product density and a varying material load (varying microwave irradiation path) may have an influence on the phase and attenuation. This influence has to be compensated for during calibration.

3.3 Temperature Compensation

Temperature compensation (TC) is required for fluctuating product temperature. It is generally advisable to provide a temperature compensation, i.e. a temperature signal (0/4...20 mA or PT100) to be connected to the evaluation unit and, optionally, to enable the compensation in the evaluation unit. The evaluation unit is designed so that the required TC's can be calculated automatically. The variation in temperature where TC becomes absolutely essential is dependent on the product and on the water content. In the first approximation, $\pm 2^\circ \text{C}$ should be set as fluctuation limit.

For example, if the product temperature is measured via the PT100 input, then Eq. 3-1 is expanded as follows:

$$\text{Measured value} = A \cdot \text{Phase} + D \cdot T_{\text{meas}} + C \quad \text{Eq. 3-2}$$

where:

Measured value Concentration / Moisture / Dry matter

A, D, C Coefficients of the calibration function

T_{meas} Product temperature

How to work with the temperature compensation is described in detail in the Software Manual.

3.4 Throughput Calculation and Output

For pipeline applications, the LB 566 allows you to calculate the throughput (mass flow) and to output the result via a current output.

The calculation is based on the microwave measured value; if this value correlates with the product density, one can calculate the throughput, if some additional information is available. The additional information needed is: internal pipe diameter/cross section and the product speed. The product speed has to be fed via current input.

For details, please see the *Software Manual, chapter 4.2.12 Mass Flow*.

3.5 Mechanical Components

The measuring system comprises an evaluation unit, a probe/antenna pair and one set of special high-frequency cables (short HF-cable). The evaluation unit is available in two versions: the standard model MicroPolar LB 566 and the high dynamics version MicroPolar ++ LB 566 (see Figure 3-4 and Figure 3-5).



*Figure 3-4:
Evaluation unit
MicroPolar
LB 566*



*Figure 3-5:
Evaluation unit
MicroPolar ++
LB 566*

The probes/antenna pairs are available in different versions, as pipeline and container probe with or without flushing device (see Figure 3-6 to Figure 3-7).

Figure 3-6:
From left:
Container probe
LB 5650 and
LB 5651 with
flushing device



Figure 3-7:
FlowCell LB 5660-102-00x
nominal width 50 mm
with V flange



The FlowCell is available in the nominal pipe sizes 50 -150 mm (50, 65, 80, 100, 125 and 150). The following connections types are available:

- Hygiene milk pipe screw connection DIN 11853-1
- V flange EN 1092-1/11

3.5.1 Evaluation Units

The evaluation units comprise the evaluation computer and the microwave unit. The microwaves are generated, received and analyzed in the microwave unit. Signal processing and communication take place in the evaluation computer. For simple operation, the measuring system includes a display, 4 softkeys and an alphanumeric keypad. Different functions are assigned to the softkeys on the display.

Differences between MicroPolar ++ und MicroPolar

The MicroPolar ++ evaluation unit has an additional HF amplifier module in comparison to the standard model; therefore, it also has a larger wall housing (dimensions see *chapter 6.1 Technical Data Evaluation Unit*). Otherwise, the evaluation units differ only in their application.

MicroPolar ++

The high dynamics version MicroPolar ++ permits higher product attenuations. Larger measuring paths can be irradiated, i.e. FlowCells with larger nominal diameters can be used. Which type of evaluation unit is used depends on the product attenuation. MicroPolar is used up to an attenuation of 50 dB; MicroPolar ++ is used for higher attenuations. The MicroPolar ++ generally requires an attenuation of 40 dB. If this attenuation is not reached, the software displays an error message.

An RS232 interface is included on the bottom side of the instrument.

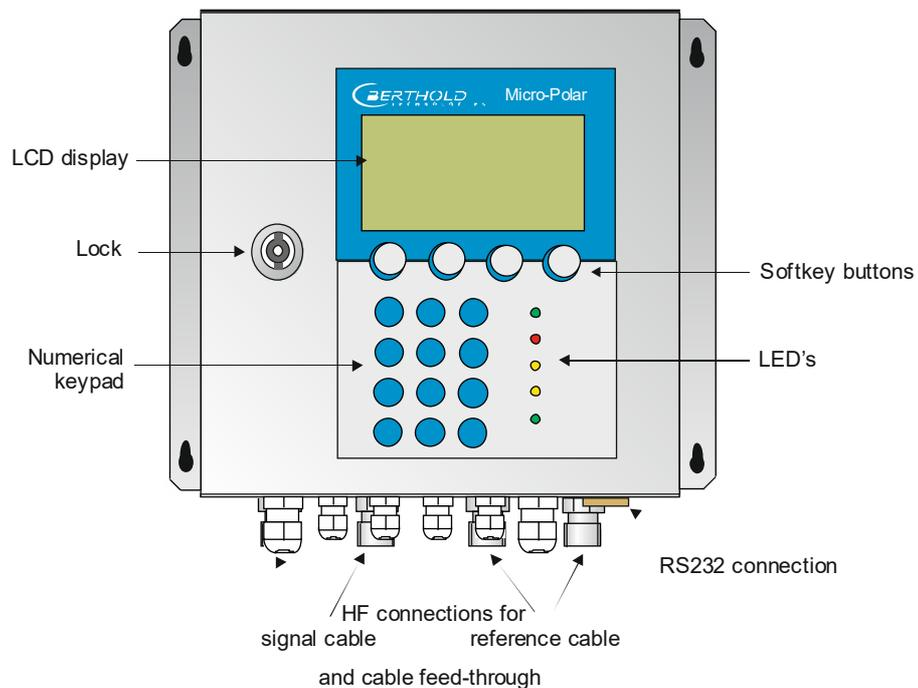

*Figure 3-8:
Evaluation unit –
front view*

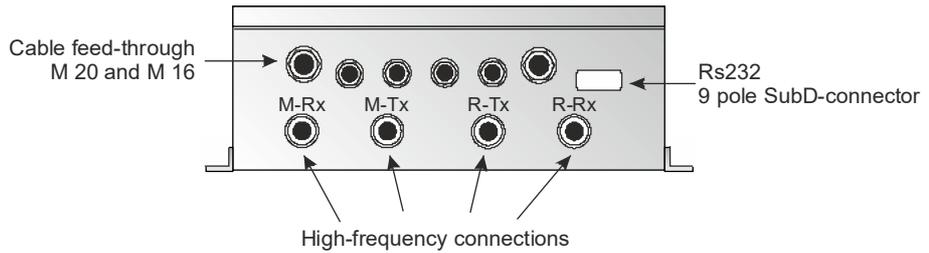

Figure 3-9:
Evaluation unit –
bottom view

Interpretation of LEDs

Five LEDs on the instrument front panel indicate the current device status.

- Run
- Error
- Signal 1
- Signal 2
- Comm

Figure 3-10:
LEDs on the
front panel of
the evaluation unit

LED	Function
Run	<u>On:</u> Device in measurement mode <u>Flashes + ERROR LED off:</u> Device in warning state, on hold, paused or low load state. A display message with error code indicates the cause (see <i>Software Manual, chapter 11. Error Lists and Device States</i>).
Error	<u>On:</u> Device in error state. A display message with error code indicates the cause (see <i>Software Manual, chapter 11. Error Lists and Device States</i>). Canceled after reset or if error has been eliminated.
Signal 1	Display depending on the selected function of relay 1, possible functions: Error, no product, alarm min., alarm max., measurement stopped, low load
Signal 2	Display depending on the selected function of relay 2, possible functions: Error, no product, alarm min., alarm max., measurement stopped, low load
Comm	Communication active, e.g. via RS232 and RS485

Terminal block

The electrical connections of the LB 566 are located on a connector strip in the wall cabinet. The terminal block can be accessed from the front by opening the cover of the housing. There, you also find the power cut-off switch and the fuses. The high-frequency terminals are located on the outside of the housing. All other elements, especially the voltage-carrying elements (on the motherboard) are provided with a protective cover.

3.5.2 FlowCell

The FlowCell is available in the nominal sizes of 50 to 150 mm (see fig. 3-11). As connection, the versions V flange EN 1092-1/11 or Hygiene milk pipe screw connection DIN 11853-1 are available. For technical data please see *chapter 6.2 Technical Data Sensors*.

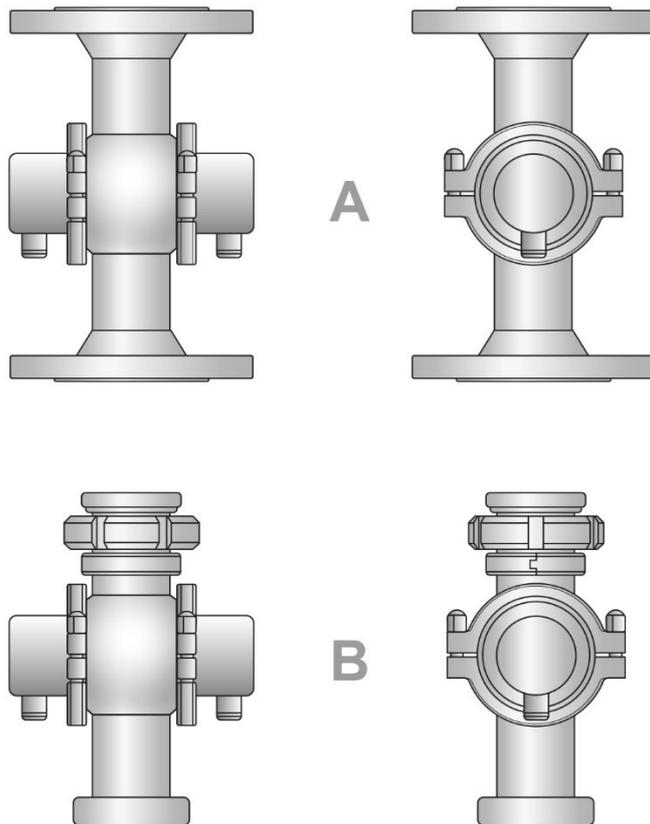

*Figure 3-11:
FlowCell versions*

A: with V flange EN 1092-1/11

B: with Hygiene milk pipe screw connection DIN 11853-1

The FlowCell consists of a sturdy stainless steel body. The microwave transmitter and receiver are firmly welded to the outside of the pipe. The entire product pipe is PTFE-coated and thus meets the special requirements for use in food for use in food.

There are no objects that extend into the pipe (e.g. a measuring sensor). Depending on the version, the FlowCell can be mounted with the V flange or milk pipe screw connection to the piping. For the versions with V flange, ASA adapter flanges are available as accessory.

The FlowCell has two HF ports to feed in and output the microwave signals. The input and output can be allocated as needed (M-Tx, M-Rx). The microwave signals transmit the product over the entire pipeline cross-section.

For all versions, the following accessories are available:

- 1. Pipe-mounted PT100 or Inline PT100
- 2. Conductivity measuring device
- 3. Sampling valve (combination with 1. and 2. possible)

Overview accessories (see also chapter 6.2):



Conductivity measuring device



Inline PT100



Pipe-mounted PT100



Sampling valve



Combination
Conductivity measuring
device with Sampling valve



Combination
Inline PT100 with
Sampling valve

3.5.3 Container Probe

The container probe is available in a version with and without flushing device (see Figure 3-12). The technical data are listed in *chapter 6.2 Technical Data Sensors*.

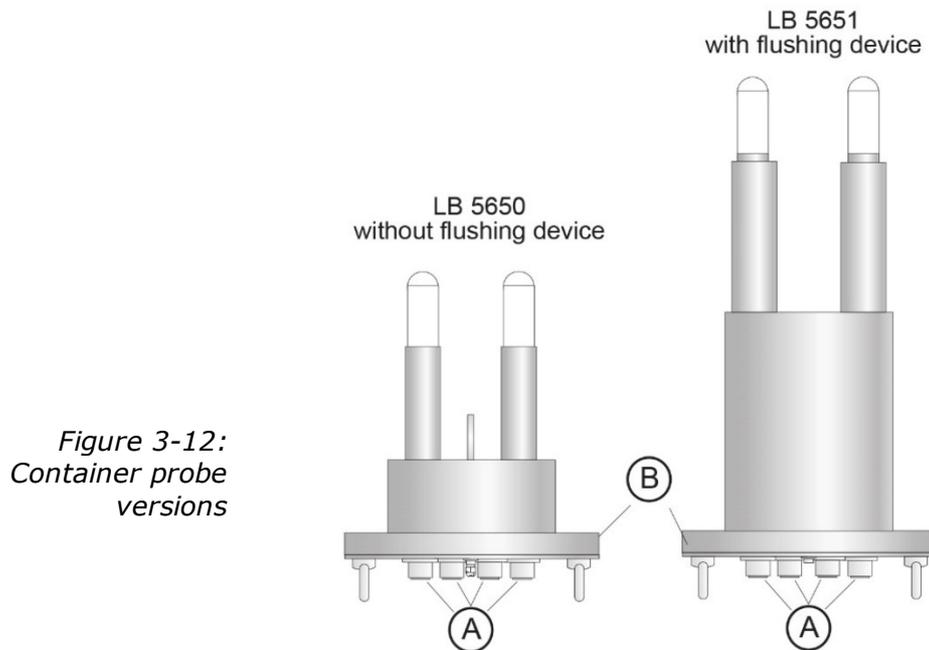

Figure 3-12:
Container probe
versions

A: High-frequency connections
B: Process connection, flanges of different sizes

Container probe type LB 5650 and type LB 5651

The container probe has been specially designed for concentration measurements in containers. Both measuring rods are immersed into the product. Microwaves are emitted from one end of the rod and received by the other end of the rod; they are emitted only towards the opposite end of the rod. This directional characteristic of the probe minimizes the interfering influence of metal parts in the vicinity of the probe and allows installation if only limited space is available. For example, the concentration of sugar strike can be measured continuously to find the suitable inoculation time.

The plastic caps of the measuring rods meet the special requirements for application in foodstuffs.

Two different probe types are available:

- The standard type is the container probe without flushing device.
- The flushing probe is used in processes where incrustations are likely to occur, for example, due to increased depositions. The flushing device prevents deposition on the microwave exit windows.

For the case depicted in Figure 3-13, the flow direction of the product being measured must be perpendicular to the drawing plane. This ensures a representative product between the measuring rods, provided the product is mixed thoroughly.

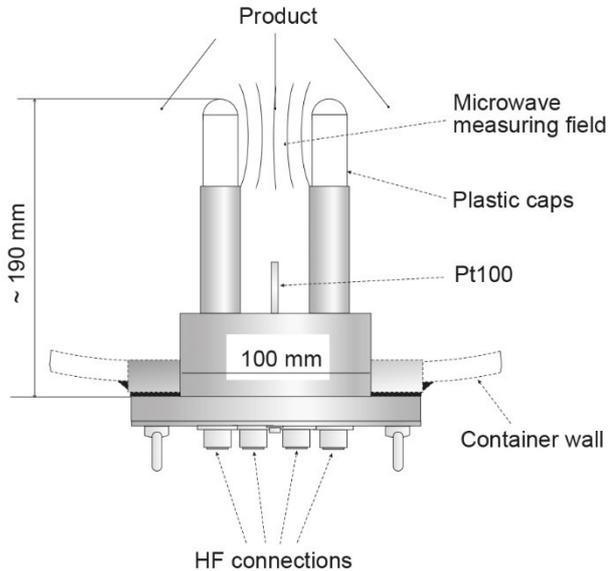

Figure 3-13:
Container probe LB 5650

PT100

The container probe LB 5650 is the only one equipped with a PT100 connection and can be connected to the evaluation unit via a 4-core cable. The PT100 wiring diagram is described in *chapter 4.6.1 Pin Configuration of the Connector Strip*. To minimize the danger of incrustation in the immediate vicinity of the measuring rods, the container flush probe is not provided with a PT100.

NOTICE

Warning: Possible material damage!
Do not open the cover screws on the front of the container probes, see Figure 3-14.

Probe flange
e.g. Container Probe DN65 / PN6

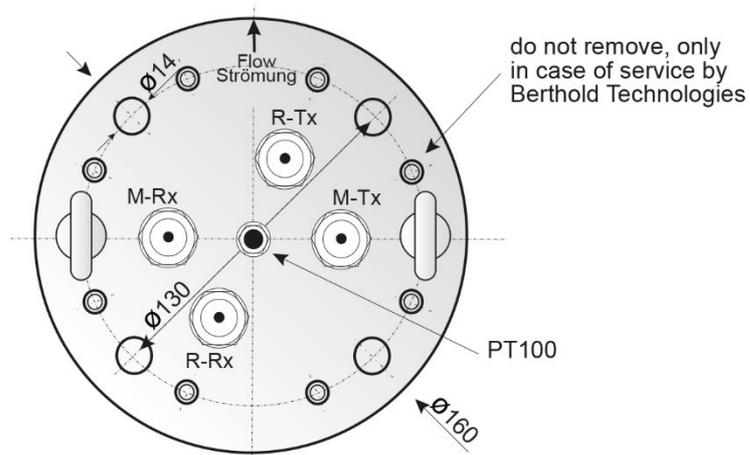

Figure 3-14:
Front view
container probe

Container probe type LB 5651 with flushing device

The flushing probe LB 5661 has been designed for processes in which depositions, for example, due to incrustations are likely to occur on the probe.

The flushing probe has two flushing channels which keep the measuring rods free from incrustations; this ensures that the microwaves come into direct contact with the product being measured. All probe parts coming into contact with the product meet the special requirements for application in foodstuffs. Figure 3-15 shows the probe design.

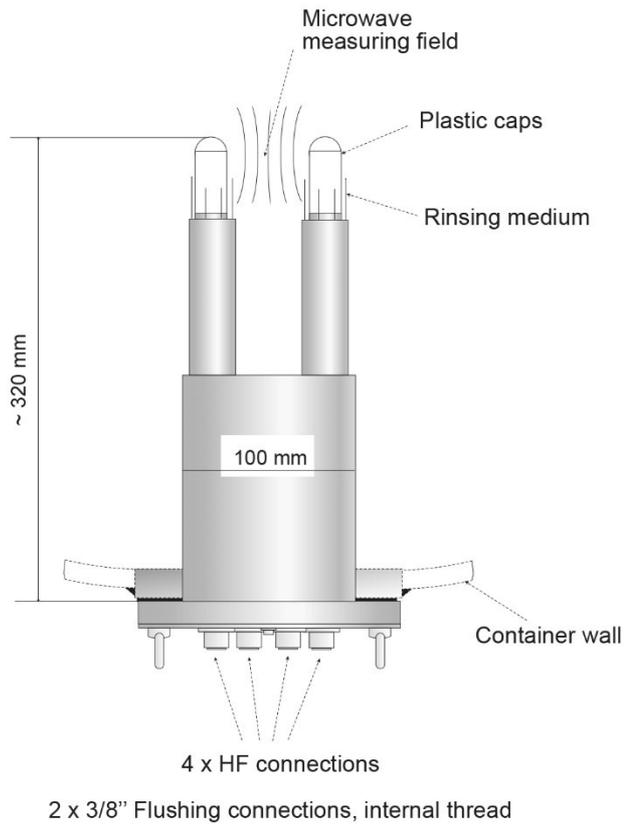

Figure 3-15:
Flushing probe
LB 5651

The flushing slit width is the same for both probe rods and is depicted in Figure 3-16.

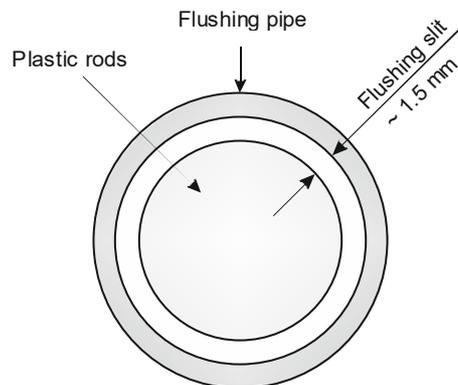

Figure 3-16:
Rod head with
flushing pipe

3.5.4 High-frequency Cable

High-frequency cables (HF cable) are used to transmit microwave signals.

HF cables change their conductivity (for microwaves) with temperature and would therefore produce measurement errors with varying ambient temperature. This error is compensated for by enabling the automatic cable compensation. The influences of the ambient temperature on the signal cable are compensated for by means of the reference cable. To this end, the sum of the reference cables has to match the length of the sum of the signal cables.

Two different HF cable types of different lengths are available:

Version 1: The so-called HF-cable quad: It consists of four single HF-cables of equal length, whose ends are terminated by one HF-connector (N-type). Available cable lengths: 2, 4, 6 and 10 m (see Figure 3-17).

The reference line of the HF cable on the probe side is short-circuited using an N-connector (see Figure 3-18).

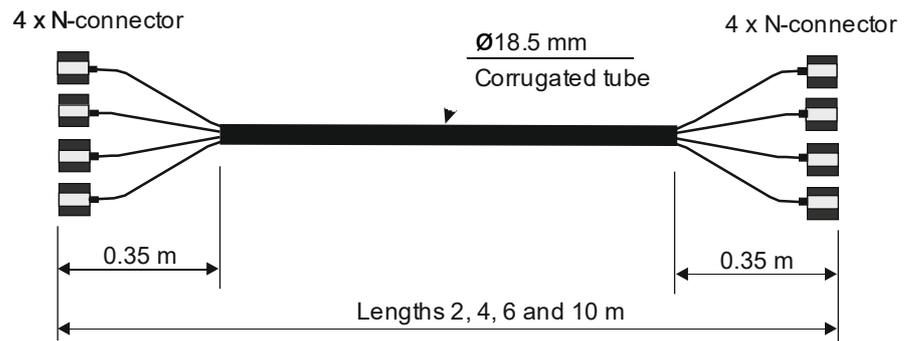

Figure 3-17:
HF cable quad

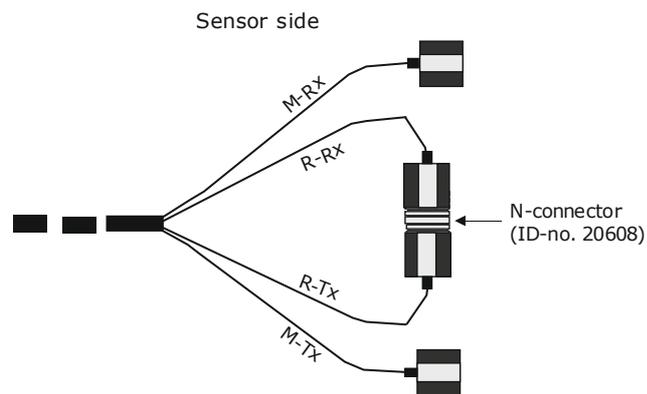

Figure 3-18:
HF cable quad
probe side:
The ends of the
reference line
R-Rx and R-Tx are
short-circuited
using an
N-connector.

Version 2: It consists of a single HF-cable whose ends are terminated by an HF-connector (N-type). Available lengths: 2, 2.5, 3, 3.5 and 4 m (see Figure 3-19).

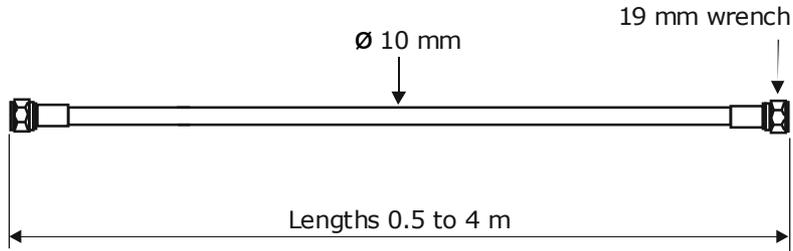

Figure 3-19:
HF cable

For further technical data see *chapter 6.5 Technical Data HF-Cable*.

NOTICE

During assembly, ensure that the end of the corrugated tube is bent down on the probe side. By doing so, the ingress of fluids into the corrugated tube is prevented.

Hygienic HF-cable

For use in hygienic applications a hygienic HF-Quad-Cable is available. It provides a complete sealing against fluids.

It is available in 2 or 4 m length.

3.6 Assembly on a Pipeline

The evaluation unit is installed close to the FlowCell to keep the HF cable between evaluation unit and probe as short as possible. The shorter the cable connection, the better the stability of the measurement. The standard length is 2 m and the maximum length of the HF cable is 10 m. The HF cable must be at least 2 m long.

The FlowCell is integrated into the existing pipeline system or in a bypass. The orientation of the FlowCell can either be vertical or horizontal. To avoid possible sedimentary deposits, vertical installation in a riser is preferred (see Figure 3-20).

The installation should preferably be close to a sample sampling point to ensure representative sampling for calibration.

A representative temperature signal (current signal or PT100) should be connected to the evaluation unit for product temperature compensation.

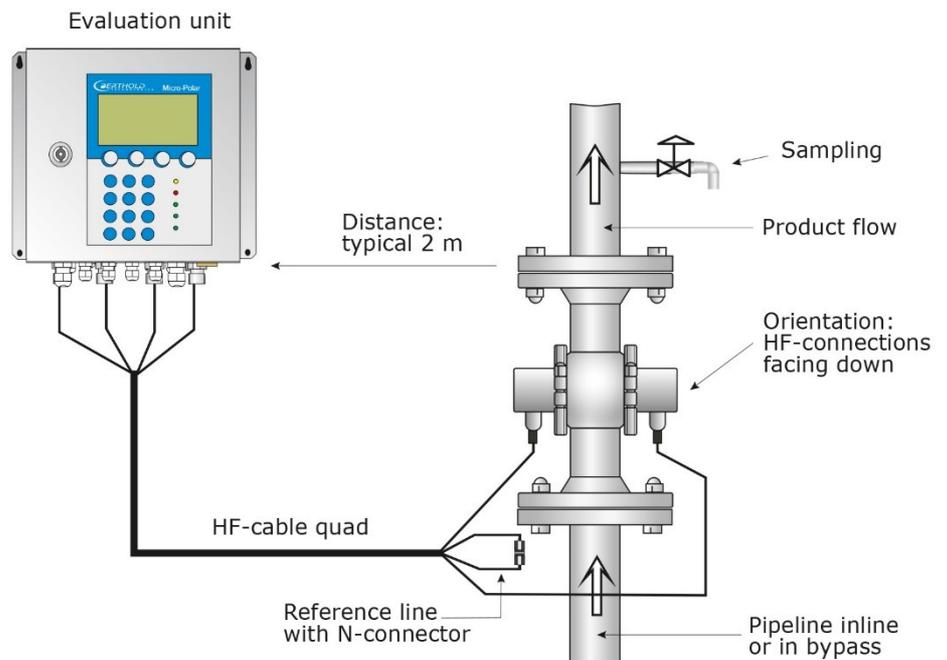

Figure 3-20:
Typical measurement
arrangement on
a pipeline

3.7 Assembly on a Container

The evaluation unit is installed in the immediate vicinity of the container probe to keep the HF-cable between evaluation unit and probe fairly short. The shorter the cable connection, the better the stability of the measurement. The standard length is 2 m and the maximum length of the HF cable is 10 m. The HF cable must be at least 2 m long.

The installation should preferably be close to a sampling point to ensure representative sampling for calibration. A representative temperature signal (current signal or PT100) should be connected to the evaluation unit for a possibly required product temperature compensation.

Our example in Figure 3-21 shows the measurement configuration on a process container. The probe is fixed to the container wall using a flange coupling so that both measuring rods are immersed into the product.

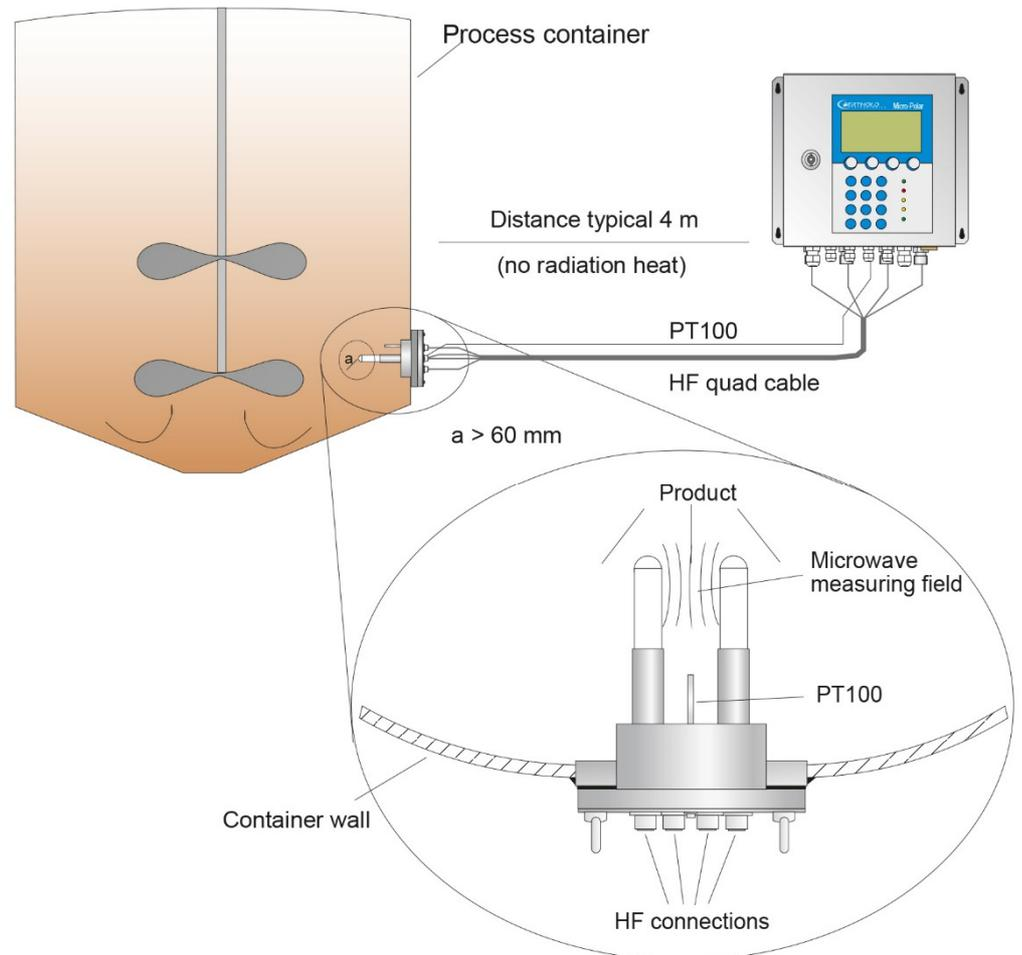

Figure 3-21:
Example:
Pipeline measurement
configuration on a
process container

Chapter 4. Getting Started

4.1 Transport

NOTICE

Warning: Possible material damage!
System parts may get damaged during transportation!

Transport all components in their original packaging.
Protect parts against shocks.
In particular, the measuring rods of the container probes must
be protected against mechanical shock!

After unpacking, make sure all parts listed on the packing list
have been delivered and show no sign of damage; if necessary,
clean these parts.

If you detect any damage, please notify the forwarder and the
manufacturer immediately.



The weight of the system components may exceed 25 kg, de-
pending on the version. We recommend, therefore, that you
wear safety boots.

4.2 Commissioning the FlowCell

4.2.1 Installing the FlowCell

 **WARNING**

Danger of injury from leaking operating medium.

The FlowCell must be mounted correctly.

In particular, the correct tightening torque for the flange screws must be observed.

Note the following points when installing the FlowCell:

- The FlowCell is integrated at a suitable location in the pipeline system. Keep in mind that material sampling directly behind the FlowCell should be possible for calibration.
- The FlowCell should be installed in a vertical riser, if possible. It must be ensured that material deposits cannot form on the pipe walls and no bubble formation occurs in the product.

When aligned horizontally, the drainability of the pipeline has to be respected. To ensure this, the FlowCell must be mounted acc. to fig. 4-2.

- There should be a straight pipe section of at least 300 mm and equal nominal width before and after the FlowCell to ensure a fairly homogeneous flow profile and to rule out possibly occurring microwave reflections in the pipeline. Also, not fittings must be installed in these pipe sections.
- No gas inclusions should be present in the product. If gas bubbles cannot be ruled out, a pressure of at least 4 bar is required in the pipeline to minimize the influence of gas bubbles. Please observe the max. permissible operating pressure, see *chapter 6.2 Technical Data Sensors*.
- The high-frequency cables should preferably be connected to the FlowCell from below to prevent flowing water from getting to the connection sockets.
- The signal and reference cable should as far as possible follow the same path to make sure both cables are exposed to the same temperature and should not come into contact with hot pipelines. We recommend installing the HF cable through a single protection tube. If you are working with the HF cable quad, this function is taken over in good approximation by the corrugated tube.

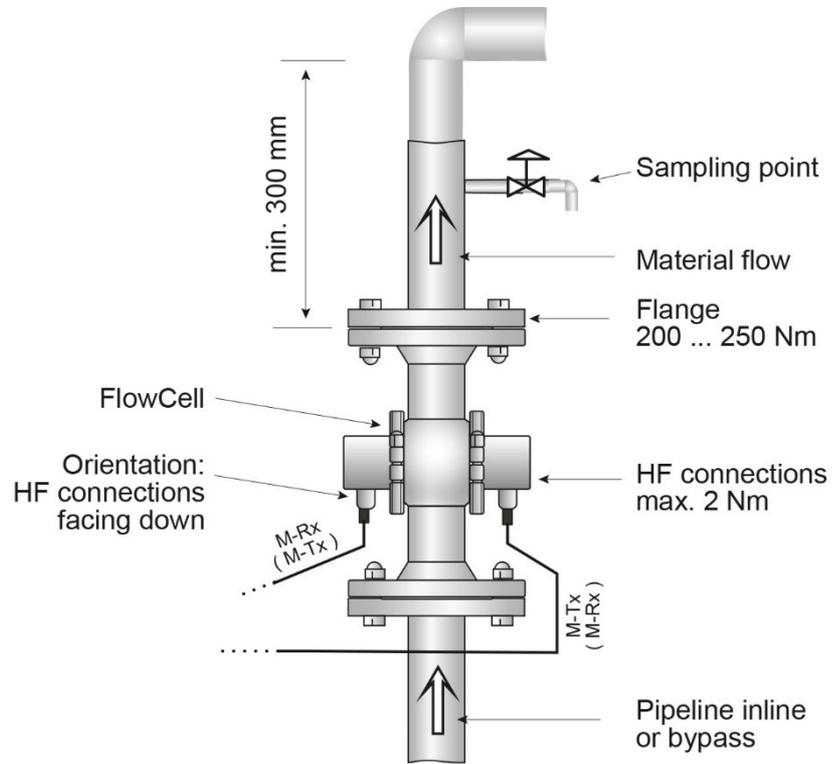

*Abb. 4-1:
Installation in a
vertical riser*

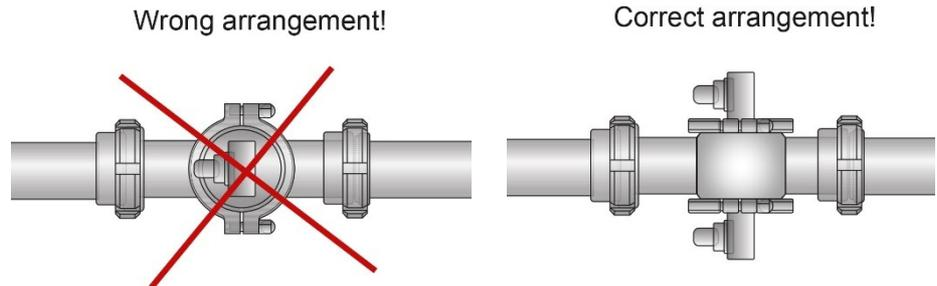

*Abb. 4-2:
Horizontal installation: The
drainability of the pipeline
must be respected. To en-
sure this, the FlowCell
must not be rotated.*

4.2.2 Installing the Evaluation Unit

Note the following points when installing the evaluation unit:

- Position the evaluation unit depending on the length of the HF cable in the vicinity of the microwave probe.
- The evaluation unit has to be protected against vibrations. In some cases, it is advisable to set up the evaluation unit on a stand separated from the pipeline system.
- For instrument installation you should foresee a cutoff device to allow easy and quick disconnection of the device from the power supply.
- Provide an automatic separating device (line circuit breaker) that disconnects the unit from power within 0.03 seconds in case of failure. The separating device must be matched to the cable cross-section of the supply line, but at least it must be designed for 1 A continuous current.
- When installing the evaluation unit on a crystallizer, use a distance rail to minimize the thermal radiation and conduction. See Figure 4-3:
- For outdoor applications, the evaluation unit must be protected from direct sunlight and rain, for example by a suitable shelter.

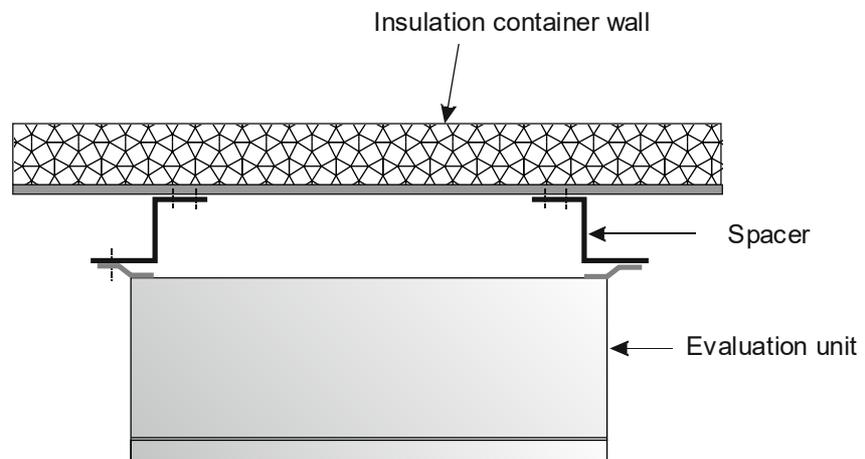

*Figure 4-3:
View from above:
Installation of the
evaluation unit on a
hot container wall*

4.2.3 Connecting the HF Cable

The FlowCell is connected with the evaluation unit via the HF cables. Two different options are available:

- Version 1: 1 x HF cable quad and 1 x N-connector
- Version 2: 2 x HF cables (as signal cable)
1 x HF cable (as reference cable)

The decision for a certain cable version is taken by Berthold Technologies in the planning stage. It is subject to the application and the desired distance between evaluation unit and FlowCell.

Prerequisite for a correct measurement is the correct installation of cables! Please keep in mind:



TIP

Make sure the cable does not get into contact with hot pipes over the entire length (corrugated tube and single cable section after splitting), e.g. direct contact with the device wall (not insulated). This will ensure that all individual cables are exposed to the same ambient conditions and that the compensation of the cable drift works properly.

NOTICE

Never bend the HF cable! The bending radius should not be less than 100 mm. Fix the HF cable with cable binders or other suitable means, so that the cable cannot slip anymore!

NOTICE

During assembly, ensure that the end of the corrugated tube is bent down on the probe side. By doing so, the ingress of fluids into the corrugated tube is prevented.

Version 1

The HF cable quad and the HF connectors on the evaluation unit are labeled. Connect the FlowCell to the evaluation unit as shown in Figure 4-4; only cables with identical labeling can be combined. The two connections on the FlowCell are not labeled, the assignment of both cable connectors M-Tx and M-Rx is arbitrary. Connect the cable connectors R-Tx and R-Mx with the N-connector (short-circuited).

Version 2

Connect the FlowCell to the evaluation unit as shown in Figure 4-5; make sure that the reference cable (ring line) is connected to R-Tx and R-Mx.

The reference cable must be as long as the sum of both signal cables.



Abb. 4-4:
FlowCell connection,
version 1



Abb. 4-5:
FlowCell connection,
version 2

Hand tighten all screwed connections of the HF cable (2 Nm = 0.2 kg/m)! Before tightening, carefully screw on the cable by hand. **Caution! Threaded joint jams easily.**

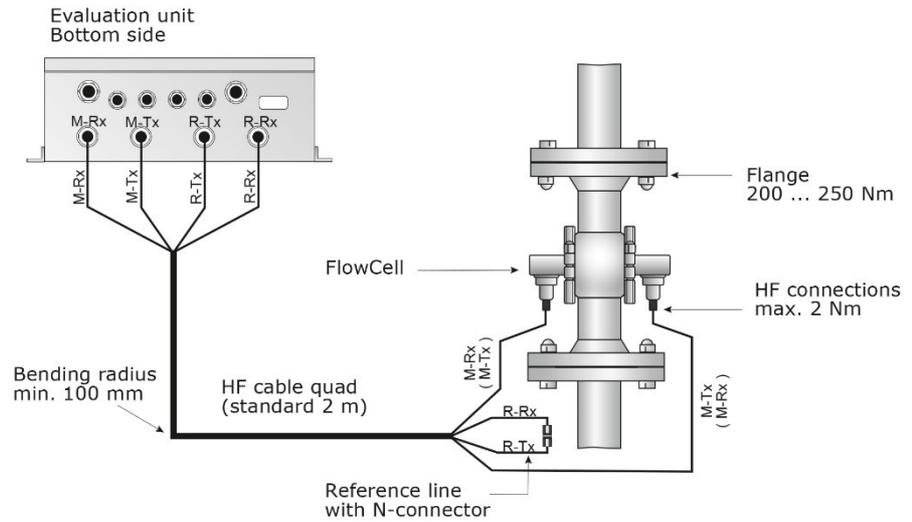
Check occasionally if the screwed connection is still properly tightened. If the installation is exposed to vibrations, the screwed connection may come loose and this may result in inaccurate measurements or corrosion of the connections.

As long as the cables are not connected, the coaxial sockets have to be covered with plastic caps and the cable connectors have to be protected against moisture and dirt.

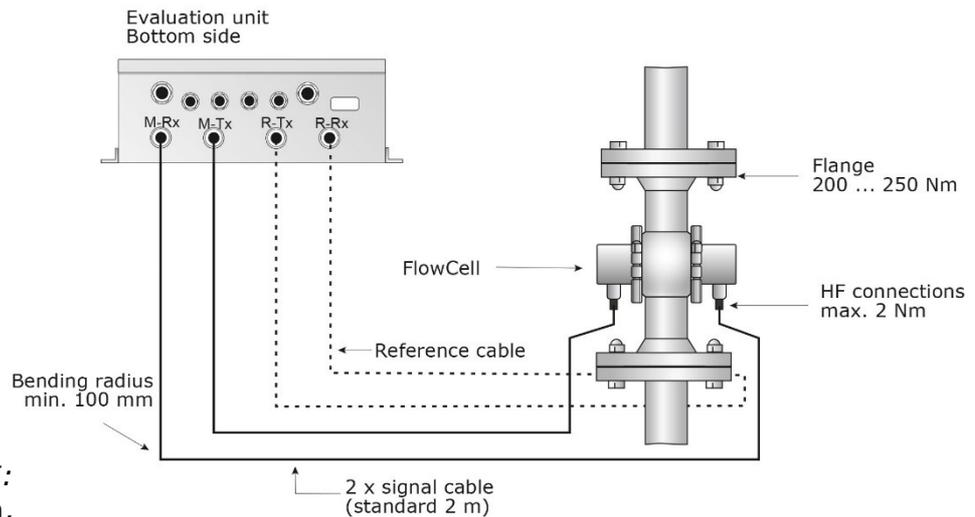
4.3 Commissioning the Container Probe

4.3.1 Installing the Container Probe

 **WARNING**

Danger of injury from leaking operating medium.

The Container probe must be mounted correctly.

In particular, the correct tightening torque for the flange screws must be observed.

For installation of the probes, please keep in mind:

- Select the installation site such that good mixing and a homogeneous product are ensured and no bubbles are present in the probe. A sample tap should be available in the direct vicinity to allow representative sampling.
- The probe must be flanged to the container so that the material to be measured flows between the two measuring rods. That means the fork (both measuring rods) must be installed perpendicular to the material flow.
- The distance between the measuring rod tips and any metalized walls (heating element, stirrer, container wall) should be at least **60 mm**.
- The following **mounting hole dimensions in the fitting flange** are required for installation of the probe:

Flange	Minimum mounting hole size \varnothing (mm)
DN 65 / PN 6	102 ± 0.3
others	104 ± 0.5

- For further installation dimensions, such as the required installation depth, please refer to *chapter 8.6* and *8.7 Assembly Sheets*.
- Use the appropriate flat gasket (standard accessory) to compensate for minor surface tolerances in the fitting flange.

Installation on process containers

Figure 3-26 shows the position of the container probe on the container. This position is also valid for the container flush probe. Follow the instructions in *chapter 3.9 Assembly on a Container*.

The assembly sheets in *chapters 8.6 and 8.7* include all the information required for installation.

Dismounting in the event of a stuck flange

Depending on the process, the probe flange may stick to the process flange. In such case, during the dismounting process, remove the two eyebolts first. Then insert two longer screws (M8) into their bore holes up to the process flange. If you continue to rotate the screws, you will push the probe away from the process flange.

Installation in pipelines

Container probes can be installed in pipelines with a nominal width ≥ 200 mm using an adapter flange. Note the position and orientation of the container probe, see the technical drawings in *chapter 8.4.7 and 8.5.6 Installation Situation in Pipelines*.

Connecting the flushing pipes

The container probe with flushing device has two flushing connections with G3/8" female thread (DIN ISO 228-1). The flushing connections should be sealed only at this thread. Sealing the probe cover, for example with silicone, is not permitted.

If the flushing pipe is not connected, the container probe must be closed with a blind plug.

Flushing parameters (only for flushing probe)

The degree of deposition or incrustation is essential for the flush settings, i.e. flush interval and flush duration. The flushing parameters must be matched to the product and the process.

The following product and process independent flushing parameters must be strictly adhered to:

Flush solution	Water, condensate
Temperature of flush solution	Maximum 120°C
Pressure	≥ 3 bar, max. 8 bar
Fittings	2 x G3/8" female thread (DIN ISO 228-1)
Supply pipe	$\geq 1/2$ inch

In general: The flushing connections can be flushed simultaneously or sequentially. The flushing parameters are valid for each flushing connection.

**TIP**

The flush duration has to take into account possible inertias of the system, e.g. valve openings. The flush supply pipes must be well insulated to prevent that the flush solution is initially colder.

Amounts of water

With a 5 bar flushing pressure, the amount of water per flushing connector is approximately 0.8 liters per second.

4.3.2 Setting Up the Evaluation Unit

Set up the evaluation unit as described in *chapter 4.2.2*.

4.3.3 Connecting the HF Cable

Connect the container probe to the evaluation unit via the HF cable quad.

Prerequisite for a correct measurement is the correct installation of cables! Please keep in mind:

**TIP**

Make sure the cable does not get into contact with hot pipes over the entire length (corrugated tube and single cable section after splitting), e.g. direct contact with the device wall (not insulated). This will ensure that all individual cables are exposed to the same ambient conditions and that the compensation of the cable drift works properly.

NOTICE

Never bend the HF cable! The bending radius should not be less than 100 mm. Fix the HF cable with cable binders or other suitable means, so that the cable cannot slip anymore!

The HF cables and the HF connections on the evaluation unit and on the probe are labeled. Connect the probe to the evaluation unit as shown in Figure 4-6; only cables with identical labeling can be combined.

Figure 4-6:
Connecting the
container probe
to the
evaluation unit

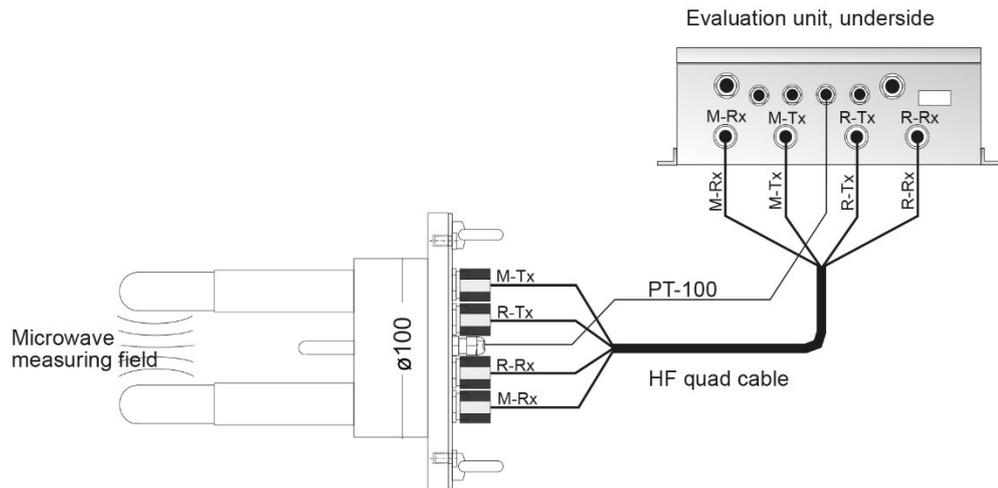

Hand tighten all screwed connections of the HF cable (2 Nm = 0.2 kg/m)! Before tightening, carefully screw on the cable by hand. **Caution! Threaded joint jams easily.**

Check occasionally if the screwed connection is still properly tightened. If the installation is exposed to vibrations, the screwed connection may come loose and this may result in inaccurate measurements or corrosion of the connections.

As long as the cables are not connected, the coaxial sockets have to be covered immediately with plastic caps and the cable connectors have to be protected by suitable provisions against moisture and dirt.

4.5 Connecting the Evaluation Unit

 **WARNING**

Electrical hazards:

Disconnect power to rule out any contact with live parts during installation and servicing.

Turn off power before opening the instrument.
NEVER work on open and live instruments.

NOTICE

Caution! Potential hazards, material damage!

Device type:

LB 566-12 MicroPolar ++ (ID no. 51833-02)

When connecting the 24 V DC power supply, the + and – poles must be connected correctly. There is no reverse polarity protection!

The line cross-section for the power supply must be at least 1.0 mm².

- Connect all desired input and output signals to the terminal strip as shown on the following pages. Use the M feed-through to keep the degree of protection.
- Check if the voltage indicated on the type plate matches your local supply voltage.
- Connect the deenergized power cable to the terminals 3(L1), 2(N) and 1(PE).
- Verify that the test switch (power interruption) is in position "ON" (see Figure 5-1).
- Close the instrument housing and turn on the power supply.

4.5.1 Pin Configuration of the Connector Strip

The connector strip of the evaluation unit includes the following terminals:

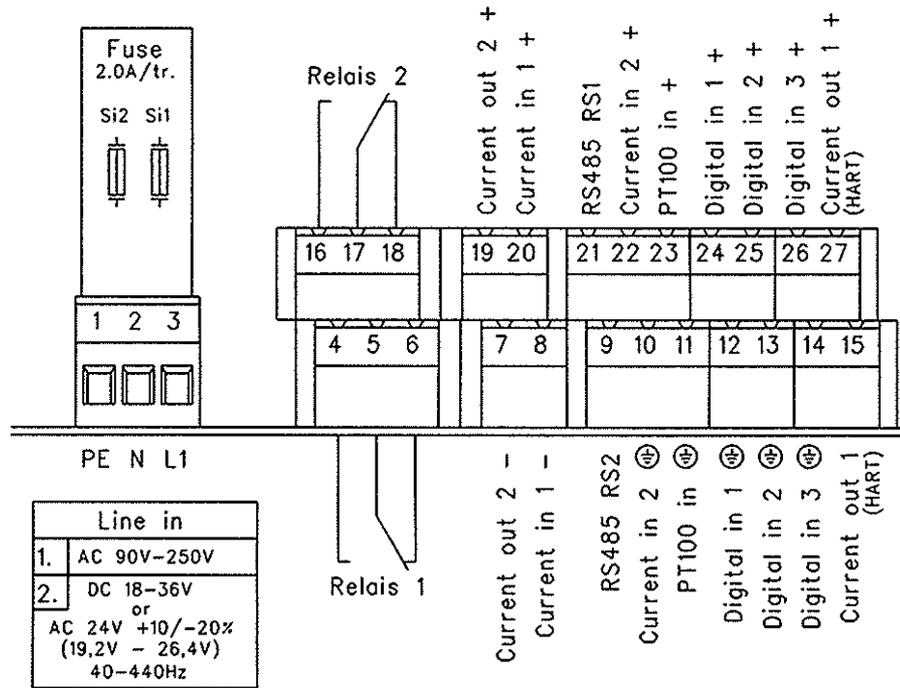

Figure 4-7:
LB 566 wiring diagram

Power supply: Terminals 3 (L1, +), 2 (N, -) and 1 (PE, ⊕)

For MicroPolar, depending on device type, see name plate on the housing outer wall.

- 1.) 100...240 V AC, 45...65 Hz
- 2.) 24 V DC: 18...36 V
24 V AC: -20%, +5%, 40...440 Hz

For MicroPolar ++, depending on device type, see name plate on the housing outer wall.

- 1.) 100...240 V AC, 45...65 Hz
- 2.) 24 V DC: 18...36 V, no reverse polarity protection

Current input no. 1 (terminals 20+ and 8-), insulated Current input no. 2 (terminals 22+ and 10-), not insulated

Input as 0/4 - 20 mA signal. For example, for temperature compensation or reference signal recording.

Current output no. 1 (terminals 27+ and 15-), insulated

Output as 4 - 20 mA signal. Output options: Concentrations (1 / 2), current input signals (1 / 2), PT100 signal, mass flow

Current output no. 2 (terminals 19+ and 7-), insulated

Output as 0/4 - 20 mA signal. Output options same as for current input no. 1.

PT100 (terminals 23+ and 11-)

Connection for temperature measurement.

When commissioning the container probe, connect the 4-core cable of the PT100 to the connector strip of the evaluation (see fig. 4-8). Connect the other end of the cable with the corresponding plug on the container probe (see fig. 4-6).

Figure 4-8:
PT100 connection
container probe

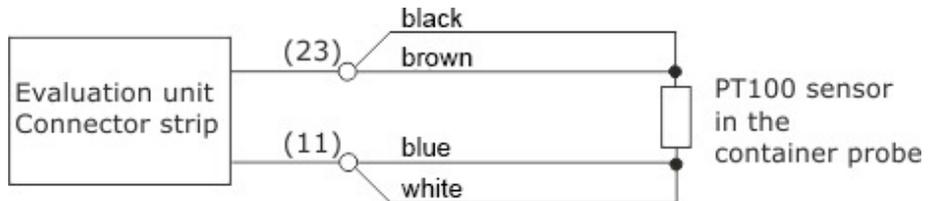

() Terminal no.

NOTICE

In the delivered state, the PT100 cable has a length of 10 meters. We recommend shortening the cable to the required length.

Combine the two core pairs in accordance with figure 4-8.

After connection of the PT100 cable, the included ferrite core must be wound around the cable. The applicable position is within the housing, as close as possible to the cable bushing.

Figure 4-9:
Ferrite core



Digital input 1: DI1 (terminals 24+ and 12-)

Only for potential-free contacts! Configuration options:

- No function
- Measurement: Start (closed) and stop (open)

Digital input 2: DI2 (terminals 25+ and 13-)

Only for potential-free contacts! Configuration options:

- No function
- Average value: hold (closed) and continue averaging (open)
- Product selection: product 1 (open) and product 2 (closed)

Digital input 3: DI3 (terminals 26+ and 14-)

Only for potential-free contacts! Configuration options:

- No function
- Start sampling, open: no action, closed: unique measurement starts
- Product selection

**Relay 1: (Terminals 4, 5 and 6) and
Relay 2: (Terminals 16, 17 and 18)**

Changeover contacts (SPDT), insulated, configuration option:

- No function
- Error message
- Stop measurement
- Limit value min. and max.
- No product
- Below load limit

**RS485 interface (terminals 21 (RS1) and 9 (RS2)) and
RS232 interface (on instrument underside)**

Serial data interface for output of the live data (all readings for every sweep (measuring cycle), the protocol and data logs.
Data format: Data transfer rate 38400 baud, 8 data bits, 1 stop bit, no parity, no handshake

4.5.2 Digital Outputs, Relay

The status of the measurement is output via two relays:

- Error
- Alarm (alarm min. and max.)
- No product

On the Plausibility menu, you can enter a min. attenuation for pause detection (e.g. for process pause, no product present); if this value is not reached, „No product“ is signaled via a relay and the current output drops to 0 or 4 mA.

- Measurement stopped
- Below load

The respective switching state is also signaled via LEDs on the front panel (LEDs signal 1 and 2).

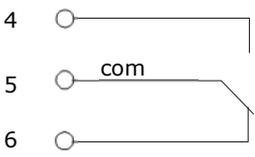
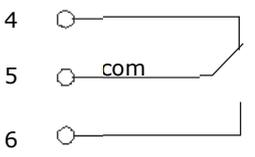
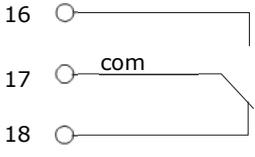
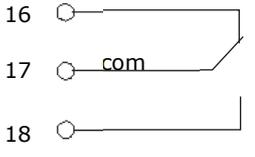
Relay no.	Error, alarm, no product, measurement stopped, Below load, currentless condition	Normal
1		
2		

The relays with changeover contacts can either be operated as make contact, terminals 4 & 5 (open at error, alarm ...) or as break contact, terminals 5 & 6 (closed at error, alarm ...).

Chapter 5. Service instructions

5.1 General Information

A malfunction of the measuring system is not always due to a defect in the instrument. Often the error is caused by incorrect operation, improper installation or irregularities in the product being measured. If a malfunction occurs, anyway, the measuring system helps you to identify and eliminate errors by displaying error messages on the display, indicating operator errors and defects of the electronics.

Defective modules of the evaluation unit cannot usually be repaired but must be replaced. The microwave module is firmly bolted to a screening hood and must not be opened.

For device disposal, please contact the Berthold Service and apply for a recycling passport.

5.2 Wear Parts

The evaluation unit does not include any parts that are subject to wear or components that require special maintenance.

The plastic caps of the measuring rods of the container probes and the PEEK Microwave windows of the FlowCell may be subject to abrasion over the course of time. A low to medium abrasive influences the measurement only very little and can be compensated for by a calibration. Therefore, check the wear parts in intervals of about 2 years. In case of heavy wear, the plastic caps of the measuring rods of the container probe and the PEEK Microwave windows of the FlowCell can be replaced.

Replacing the plastic caps of the measuring rods

- 1 Unscrew the two plastic caps from the measuring rods and remove the four sealing rings (see figure 5-1, yellow arrow).
- 2 Clean the four grooves of the sealing rings with a lint-free (if necessary wet) cloth.
- 3 For each measuring rod, insert two new sealing rings into the grooves.
- 4 Screw on the two new plastic caps.

Figure 4-7:
PT100 connection
container probe

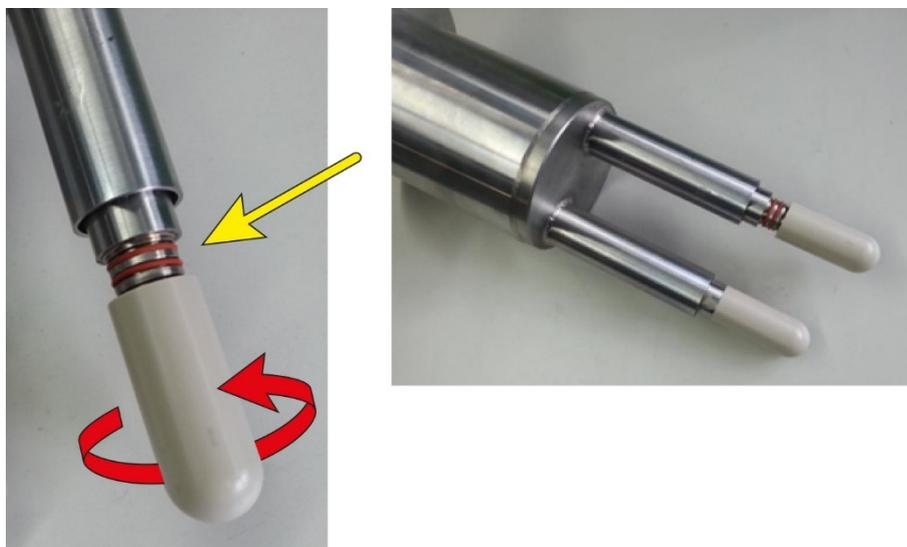

Caps set for container probe	
Id.-Nr. 66049-S	2 pieces of PEEK plastic caps with 4 sealing rings

Replacing the Microwave windows of the FlowCell

- 1** Open the fixing clamp (see fig. 5-2, item 1).
- 2** Remove the antenna (see fig. 5-2, item 2), the microwave window (see fig. 5-2, item 3) and the sealing O- rings.
- 3** Attach the new microwave window, the new sealing O-rings and the antenna to the FlowCell with the fixing clamp according to fig. 5-3.

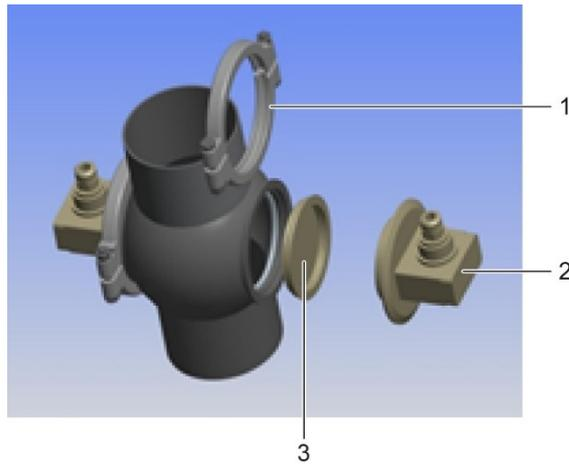

*Figure 5-2:
Antenna and Microwave
window*

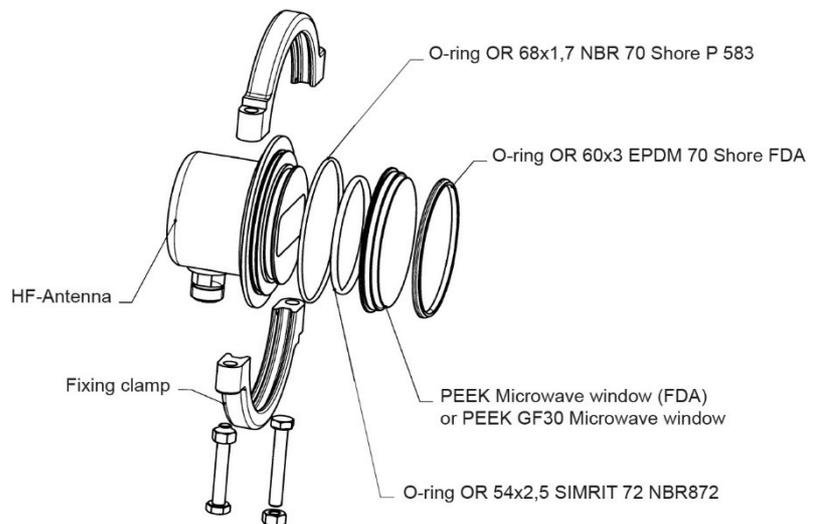

*Figure 5-3:
Assembly Microwave
window*

NOTICE

It is recommended to always change the complete set of sealing O-rings.

Microwave windows set for FlowCell	
Id.-Nr. 66624-S	2 pieces of PEEK Microwave windows with 6 sealing O-rings
Id.-Nr. 66625-S	2 pieces of PEEK Microwave windows GF30 glass fibre reinforced with 6 sealing O-rings

5.3 Instrument Cleaning

Clean all system components exclusively with a damp cloth with no chemical cleaning agent. Parts coming into contact with the product (during regular operation) can be cleaned with warm water, taking into account the temperature limits, see *chapter 6.2 Technical Data Sensors*.

5.4 Battery

If the measuring system LB 566 is a long time without power supply (power failure or disconnected from the mains supply), the system clock is powered by the lithium battery on the motherboard.

If the battery voltage is no longer sufficient, the error message CODE 14 "Battery voltage" appears after a restart of the evaluation unit. After acknowledging the error message, the unit continues to work properly; however, the date and time should be checked and corrected, if necessary. Measurement data that are output via a serial interface can be fatally damaged by incorrect date and time information. We recommend changing the batteries immediately.

The service life of the battery, even under continuous stress, is approximately 8 years. Replacement of batteries must be carried out in a device disconnected from mains.

Battery type: 3 Volt lithium cell (button cell), type CR2032

5.5 Fuse Replacement

The mains fuses of the LB 566 are located in the wall housing. Replace the fuses only if the instrument is disconnected from mains.

Use only fuses with the correct rating, see *chapter 6.1*

NOTICE

Spare fuses must match the rating specified by the device manufacturer. Short-circuiting or manipulation is not permitted.

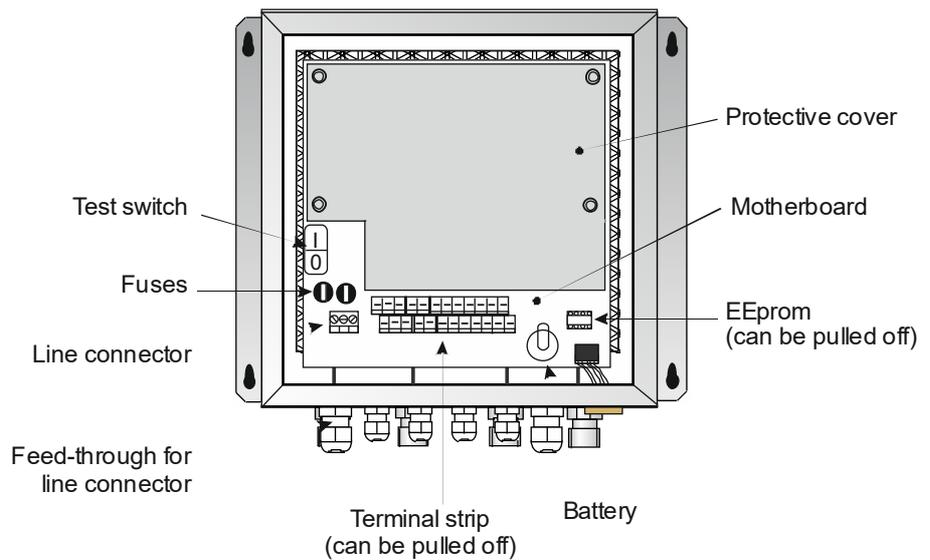

*Figure 5-4:
View with open
housing wall
MicroPolar*

Chapter 6. Technical Data

General specifications	
Method	Microwave transmission measurement
Operating frequency	2.4 - 2.5 GHz (ISM band), depending on local regulations
Transmission power	MicroPolar: < 0.1 mW (< - 10 dB) MicroPolar ++: < 10 mW (< 10 dBm) All coaxial line power
Application	Concentration / moisture measurement in containers and pipelines

6.1 Technical Data Evaluation Unit

Evaluation unit	
Housing	Wall housing made of stainless steel, see dimensional drawing in <i>chapter 8</i> MicroPolar: HxWxD: 300 x 323 x 140 mm MicroPolar++: HxWxD: 400 x 338 x 170 mm
Protection type	IP 65
Weight	MicroPolar: approx. 6.5 kg MicroPolar ++: approx. 8.0 kg
Ambient conditions during operation	-20 ... +60 °C (253 K ...333 K), no condensation Relative humidity: max. 80 % Altitude: max. 2000 m
Ambient conditions during storage	-20 ... +70 °C (253 K ...343 K), no condensation Relative humidity: max. 80 %
Achievable accuracy	≤ 0.2 weight % (standard deviation) depending on product and sensor
Display	Dot matrix LC display, 114 mm x 64 mm, 240 x 128 pixels, with back-lighting, au- tomatic contrast setting
Keyboard	Freely accessible foil keypad, light-stable and weatherproof: alphanumeric key- board and 4 softkeys (software-assigned buttons)

Power supply	For Micro Polar, depending on device type: 1.) 100 ... 240 V AC, 45 ... 65 Hz 2.) 24 V DC: 18...36 V; 24 V AC: -20%, +5%, 40 ... 440 Hz For MicroPolar++, depending on device type: 1.) 100 ...240 V AC, 45...65 Hz 2.) 24 V DC: 18...36 V, no reverse polarity protection
Power consumption	For Micro Polar: max. 30 VA (AC/DC), depending on configuration For MicroPolar ++: max. (48/60) VA (AC/DC), depending on configuration
Fuses	For Micro Polar: 2 x 2.0 A / slow-blow For MicroPolar ++: 2 x 2.0 A / slow-blow at 100 ... 240 V AC or 2 x 6.3 A / slow-blow at 24 V DC
Battery type	3 V Lithium button cell, type CR2032
Measured value	e.g. concentration, dry matter content
Inputs and outputs	
Cable cross-section	min. 1.0 mm ² (mains supply)
Cable feed-through	2 x M20x1.5 for cable 5...14 mm (depending on application) 4 x M16x1.5 for cable 5 ...8 mm (depending on application)
Sensor connection	Inputs and outputs for signal and reference channel, 50 Ω N-socket
HF cable	Cable lengths: 2, 4, 6 and 10 m; 50 Ω ; both sides with 4 N connectors
Current input	2 x current input 0/4 ...20 mA, ohmic resistance 50 Ω, 1x insulated, 1x instrument ground e.g. for temperature compensation
Current output	Current output 1: 4...20 mA, ohmic resistance max. 800 Ω , insulated Current output 2: 0/4...20 mA, ohmic resistance max. 800 Ω , insulated e.g. for measured value or temperature output
PT100 connection	Measuring range: -50 ... +200 °C (223 ... 473 K); measurement tolerance: < 0.4 °C

Digital input	<p>3 x digital inputs (DI1..3), for floating connectors (do not connect to a power supply).</p> <p><u>Configuration options:</u> DI1: none, measurement start/stop DI2: none, measurement hold, product selection DI3: none, sampling, product selection</p> <p><u>Function description:</u></p> <ol style="list-style-type: none"> 1. Measurement (Start/Stop), <u>open:</u> Measurement stopped, <u>closed:</u> Measurement started and/or measurement running 2. Hold measurement, <u>open:</u> measurement running, <u>closed:</u> measurement stopped, i.e. average values and current output are held 3. Product selection via a DI: <u>open:</u> Product 1 (P1), <u>closed:</u> P2 Product selection via two DI's: <u>DI2 & DI3 open:</u> P1 <u>DI2 closed & DI3 open:</u> P2 <u>DI2 open & DI3 closed:</u> P3 <u>DI2 & DI3 closed:</u> P4 4. Start sampling: <u>open:</u> no actions, <u>closed:</u> single measurement starts
Relay outputs	<p>2 x relays (SPDT), insulated</p> <p><u>Configuration options:</u></p> <ul style="list-style-type: none"> - Collective failure message - Stop measurement - Limit value (min. and max.) - No product - Low load <p><u>Load capacity:</u> AC: max. 400VA DC: max. 90W AC/DC: max. 250V, max. 2A, non-inductive ≥ 150V: voltage must be grounded</p> <p>The cable used at the relay output must correspond to a mains cable.</p> <p><u>Restrictions at 24 V AC/DC (DC: 18 ...36 V; AC: 24 V +5 %, -20 %) mains supply, if the ground conductor is not connected to terminal 1 (PE):</u> AC: max. 50 V DC: max. 70 V</p>
Serial interfaces	<p>RS232 on the bottom side RS485 via terminal strip Data format: 38400 Bd, no handshake, 8 data bits, 1 stop bit, no parity</p>

6.2 Technical Data Sensors

FlowCell	
Application	Microwave FlowCell with various nominal diameters and flanges for concentration measurement on pipelines
Material	Inline housing made of stainless steel 1.4404 polished (AISI 316L) Mikrowave windows made of PEEK Product touching sealing made of EPDM
Process coupling	Two versions: 1. Hygiene milk pipe screw connection DIN 11853-1 EHEDG certified 2. Flange according to EN 1092-1/11 (V flange) FDA-approved materials Optional adapter for the V flange version with ASA flange
Process pressure	up to 16 bar (relative)
Temperature range	Product temperature: 10...130 °C (283...403 K), temporarily up to 140 Ambient temperature: -20...60 °C (253...333 K) Storage temperature: 10...80 °C (283...353 K)
Connections	2 x HF connections: N female, 50 Ω for HF cable with max. 10 m length
Versions	Nominal pipe widths from 50 ... 150 mm
Dimensions	See dimensional drawings in chapter 8.

Overview FlowCells with V flange

Designation	ID no.	Nominal width [mm]	Flange	Pressure [bar]
LB 5660-102-00x	66744-001	50	DN 50 / PN 16	16
LB 5660-202-00x	66744-002	65	DN 65 / PN 16	
LB 5660-302-00x	66744-003	80	DN 80 / PN 16	
LB 5660-402-00x	66744-004	100	DN 100 / PN 16	
LB 5660-502-00x	66744-005	125	DN 125 / PN 16	
LB 5660-602-00x	66744-006	150	DN 150 / PN 16	

Overview FlowCells with Hygiene milk pipe screw connection

Designation	ID no.	Nominal width [mm]	Pressure [bar]
LB 5660-112-00x	66744-013	50	16
LB 5660-212-00x	66744-014	65	
LB 5660-312-00x	66744-015	80	
LB 5660-412-00x	66744-016	100	
LB 5660-512-00x	66744-017	125	
LB 5660-612-00x	66744-018	150	

Overview Microwave windows set

The microwave windows of the FlowCell are available in a reinforced glass fibres design for applications with a high grade of abrasion. This design is not approved for the food sector.

Id.-Nr.	Description
66624-S	2 pieces of PEEK Microwave windows with 6 sealing O-rings
66625-S	2 pieces of PEEK Microwave windows GF30 glass fibre reinforced with 6 sealing O-rings

Overview ASA flange adapter

Designation	ID no.
ASA flange adapter set for Flow Cell 50	62324
ASA flange adapter set for Flow Cell 65	62319
ASA flange adapter set for Flow Cell 80	62328
ASA flange adapter set for Flow Cell 100	62331
ASA flange adapter set for Flow Cell 150	62335
The kit consists of two adapters, screws and two seals.	

Overview Inline housing, FDA

for temperature or conductivity sensors or sampling valve

Designation	VFL	G-BS/M
	Id.-Nr.	Id.-Nr.
Inline housing for Flowcell 50	67078	67084
Inline housing for Flowcell 65	67079	67085
Inline housing for Flowcell 80	67080	67086
Inline housing for Flowcell 100	67081	67087
Inline housing for Flowcell 125	67082	67088
Inline housing for Flowcell 150	67083	67089

Overview surface temperature sensor DN 50

Self-adhesive PT100 temperature sensor with fixing material

Connection cable 10 m, 4-wire (loose ends)

Temperature range: -50 - +200 °C

Designation	Id.-Nr.
Self-adhesive temperature sensor for DN 50	66655
Self-adhesive temperature sensor for DN 65	66656
Self-adhesive temperature sensor for DN 80	66657
Self-adhesive temperature sensor for DN 100	66658
Self-adhesive temperature sensor for DN 125	66659
Self-adhesive temperature sensor for DN 150	66660

Overview sensors

Designation	Id.-Nr.
Conductivity sensor hygienic, Clamp-flange Inductive conductivity measuring device for liquid media in hygienic applications Measurement range: 0-999 mS/cm Process connection: Clamp-flange Process pressure: Max. 16 bar Power supply: 18-36 V DC, max. 190 mA Output: 4-20 mA	66693
Temperature sensor EHEDG, Clamp-flange PT100 temperature sensor for hygienic applications Measurement range: -50 - +250 °C Length 20 mm, diameter 4 mm Process connection: Clamp-flange With connection cable 10 m (loose ends)	66694

Overview Sampling valve and accessories

Designation	Id.-Nr.
Sampling valve aseptic, Clamp-flange Aseptic Inline Sampling valve Stainless steel 1.4404 (AISI 316L), bellows PTFE Discharge port S-DN 10 without flushing connection Process connection: Clamp-flange	66738
Clamp-blind flange Clamp-blind flange for Inline housing DN 50-150 Stainless steel 1.4306 (AISI 304L)	66737
Clamp coupling 1 piece Clamp coupling for Inline housing DN 50-150 Stainless steel 1.4306 (AISI 304L)	66736

Container Probes	
Application	Container probes with and without flushing device for concentration measurement in process containers and pipelines with nominal width ≥ 200 mm.
Material	Plastic caps, stainless steel PT100 connection cable: Silicon / Teflon
Process coupling	Flange according to DIN EN 1092 type 05 DN65 / PN6, DN 80, 100, 150 / PN16; ASA flange 2.5" / 150 PSI (More on request)
Process pressure	Up to 16 bar, depending on model
Temperature range	Product temperature: 10...120 °C (283...393 K) Ambient temperature: -20...60 °C (253...333 K) Storage temperature: 10...80 °C (283...353 K)
Connections	4 x HF connections: N female, 50 Ω for HF cable with max. 10 m length
Dimensions	See dimensional drawings in chapter 8.
Accessory sealing washer	
Material	Klingersil C-4400
Thickness	3 mm
Caps set for container probe	
Id.-Nr. 66049-S	2 pieces of PEEK plastic caps with 4 sealing rings

Overview container probes and sealing washers

Designation	ID no.	Flange	Pressure [bar]	ID no. Seals
LB 5650-01	65464-01	DN 65 / PN6	6	32175
LB 5650-02	65464-02	DN 80 / PN16	16	33717
LB 5650-03	65464-03	DN 100 / PN16	16	46661
LB 5650-04	65464-04	DN 150 / PN16	16	46664
LB 5650-05	65464-05	ASA 2.5" / 150 PSI	16	46665
LB 5650-09	65464-09	ASA 3" / 150 PSI	16	50659
LB 5651-01	65937-01	DN 65 / PN6	6	32175
LB 5651-02	65937-02	DN 80 / PN16	16	33717
LB 5651-03	65937-03	DN 100 / PN16	16	46661
LB 5651-04	65937-04	DN 150 / PN16	16	46664
LB 5651-05	65937-05	ASA 2.5" / 150 PSI	16	46665

6.3 Technical Data HF Cable

HF cable Quad	
Material	Corrugated tube: Polyamide (PA6) Cable sheath: Polyethylene (PE)
Protection type	IP 66
Temperature	In operation: -30 ... +70 °C When installing: -20 ... +70 °C

Cable length [m]	ID no.
2	43431
4	43432
6	43433
8	43434
10	43435

HF-Kabel Quad, hygienic	
Material	Corrugated tube: Polyamide (PA6) Cable sheath: Polyethylene (PE)
Protection type	IP 66
Temperature	In operation: -30 ... +70 °C When installing: -20 ... +70 °C

Cable length [m]	ID no.
2	67048
4	67049

HF cable Quad (solid cable)	
Material	Cable sheath: Polyethylene (PE)
Protection type	IP 68 when unscrewed
Temperature	In operation: -40 ... +85 °C When installing: -40 ... +85 °C
Attenuation coefficient	about 0.3 dB/m

Cable length [m]	ID no.
2.0	11476
2.5	11477

3.0	11478
3.5	11479
4.0	11480

6.4 Format of Serial Data Output RS232 and RS485

Headline

Date·Time→State→Status→Synchronizer→Product→Att→Phi→R2→Tint→IN1→IN2→PT100→
C→Cm→C2→C2m→MF1→MF2

Following lines

01.01.2005·00:00:00→0000→0→0→1→0.43→5.30→0.07→0.0→0.0→0.0→0.0→
1 2 3 4 5 6 7 8 9 10 11 12

75.36→75.00→0.00→0.00→0.000→0.000¶
13 14 15 16 17 18

Column no.	Description	Format
1	Date and time	DD.MM.YY·HH:MM:SS
2	State	4 digits, HEX
3	Status: Information about the quality of the last measurement	0 : Measurement OK < 0 : Error
4	Product synchronization	5: not active 1: still asynchronous 0: all values synchronous -1: Error -2: Time too short for syn. -3: Speed outside range
5	Product number	X (1 to 4)
6	Attenuation [dB]	X.XX
7	Phase [°/GHz]	X.XX
8	Dispersion of the phase regression	X.XX
9	Device temperature [temperature unit]	X.X
10	Current input 1 [unit of current input]	X.X
11	Current input 2 [unit of current input]	X.X
12	PT100 temperature [temperature unit]	X.X
		[...] with selection of the unit g/cm ³
13	Concentration 1 live	X.XX [X.XXXX]
14	Concentration 1 averaged	X.XX [X.XXXX]
15	Concentration 2 live	X.XX [X.XXXX]
16	Concentration 2 averaged	X.XX [X.XXXX]
17	Mass flow for concentration 1	X.XXX
18	Mass flow for concentration 2	X.XXX

Special characters

“→” Tabulation “¶” Carriage return + Line feed

“.” Blank character

Chapter 7. Certificates

7.1 EC Declaration of Conformity



BERTHOLD TECHNOLOGIES GmbH & Co.KG

Calmbacher Str. 22
75323 Bad Wildbad, GermanyPhone +49 7081 177-0
Fax +49 7081 177-100
info@BertholdTech.com
www.BertholdTech.com

EC – Declaration of Conformity

We herewith confirm that the construction of the following indicated products / systems / units is brought into circulation to comply with the relevant EC regulations.

This declaration is declared void should alterations or unintended use take place without our authorisation.

Title: **Concentration-Measuring System Micro-Polar 1**

Type: **LB 566-XX**

Relevant EC regulations:

89/336/EWG (electromagnetic compatibility)
reviewed: 91/263/EWG, 92/31/EWG, 93/68/EWG, 93/97/EWG

73/23/EWG (low voltage guidelines)
reviewed: 93/68/EWG

The following norms were considered for the assessment of the products:

EN 55011:1998 + A1:1999 + A2:2002
EN 61010-1:2002-08
EN 61006-6-2:2001
EN 61000-4-2:1995 + A1:1998 + A2:2001
EN 61000-4-3:2002 + A1:2002
EN 61000-4-4:1995 + A1:2001 + A2:2001
EN 61000-4-5:1995 + A1:2001
EN 61000-4-6:1996 + A1:2001
EN 61000-4-11:1994 + A1:2001

This declaration is issued by the manufacturer:

BERTHOLD TECHNOLOGIES GmbH & Co. KG
P.O. Box 100163
D-75312 Bad Wildbad / Germany

by



Dr. J. Briggmann
Development Manager
Process Control

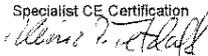

H. Tetzlaff
Specialist CE Certification

Bad Wildbad, 04.05.2004

Registergericht / Court of Registration
Persönlich haftende Gesellschafterin / Fully liable Associates
Registergericht / Court of Registration
Geschäftsführung / Management
Beiratsvorsitzender / Chairman of the Board
USt.-IdNr. / VAT Reg.No
Deutsche Steuernummer / German Tax No

Calw HRA 991
BERTHOLD TECHNOLOGIES Verwaltungs-GmbH
Calw HRB 1529
Hans J. Oberhofer (Vors./CEO), Dr. Wilfried Reuter
Dr. Fritz Berthold
DEB13059511
49038/08038

Dresdner Bank 75105 Pforzheim Konto/account no.6 511 120 (BLZ 666 800 13)/ SWIFT-BIC DRES DE FF 666 IBAN: DE05 6668 0013 0651 1120 00
Sparkasse PF-CW 75323 Bad Wildbad Konto/account no.80 450 05 (BLZ 606 510 70)/ SWIFT-BIC PZHSDE66 IBAN: DE76 6065 1070 0008 0450 05



BERTHOLD TECHNOLOGIES GmbH & Co.KG

Calmbacher Str. 22
75323 Bad Wildbad, Germany

Phone +49 7081 177-0
Fax +49 7081 177-100
info@Berthold.com
www.Berthold.com

EC-Declaration of Conformity

We herewith conform that the construction of the following indicated products / systems / units is brought into circulation to comply with the relevant EC regulations.

This declaration is declared void should alteration or unintended use take place without our authorisation.

Description: **Concentration-Measuring Systems
Micro-Polar ++**

Type: **LB 566-XX**

	EC-Regulation	and Reviews	considered Norms	
EMC	2004/108/EG		EN 55011	1998 +A1:1999 +A2:2002
			EN 61326-1	2006-05
			EN 61000-4-2	1995 +A1:1998 +A2:2001
			EN 61000-4-3	2006-12
			EN 61000-4-4	2004
			EN 61000-4-5	1995 +A1:2001
			EN 61000-4-6	1996 +A1:2001
			EN 61000-4-11	1994-08 +A1:2001-02
			Namur NE21	2004
Low Voltage Directive	73/23/EWG	93/68/EWG	EN 61010 Part 1	2002-08
R&TTE	1999/5/EC		ETSI EN 300 440-1	2007-08
			ETSI EN 300 440-2	2007-08

This declaration is issued by the manufacturer

BERTHOLD TECHNOLOGIES GmbH & Co. KG
Calmbacher Str. 22
75323 Bad Wildbad, Germany

updated by

Dr. Wilfried Reuter
Technical Director
Bad Wildbad, 06.06.2008

Registergericht / Court of Registration
Persönlich haftende Gesellschafterin / Fully liable Associates
Registergericht / Court of Registration
Geschäftsführung / Management
Beiratsvorsitzender / Chairman of the Board
USt.-Id-Nr. / VAT Reg. No.
Deutsche Steuernummer / German Tax No.
WEE-Reg. No.

Stuttgart HRA 330991
BERTHOLD TECHNOLOGIES Verwaltungs-GmbH
Stuttgart HRB 331520
Hans J. Oberhofer, Dr. Wilfried Reuter
Dr. Fritz Berthold
DE813050511
49038/08038
DE99468690

Dresdner Bank 75105 Pforzheim Konto/Account No. 6 511 120 (BLZ 666 800 13) /SWIFT-BIC DRESDEFF 666 IBAN: DE05 6668 0013 0651 1120 00
Sparkasse PF-CW 75323 Bad Wildbad Konto/Account No. 80 450 03 (BLZ 666 500 85) /SWIFT-BIC PZHSDE66 IBAN: DE37 6665 0085 0008 0450 03

CERTIFICATE OF COMPLIANCE



Valid until end: December, 2018

*TUM Certification
hereby declares that the product*

microwave flow cell with PEEK windows and EPDM O-ring seals in size DN50 – DN150

from

Berthold Technologies GmbH & Co. KG, 75323 Bad Wildbad, Germany

*has been evaluated for compliance with the
Hygienic Equipment Design Criteria of the EHEDG, by:*

*TUM (Forschungszentrum für Brau- u. Lebensmittelqualität) at Weihenstephan, Germany
and meets the criteria as demonstrated by:*

Evaluation Report No. 596TUM2017

Signed Jürgen Hofmann
Dr. Jürgen Hofmann

Evaluation Officer

Signed Fritz Jacob
Prof. Dr. Fritz Jacob

Head of Department

Date of issue: 13 November 2017

Certificate No. 17/2017



*85354 Freising-Weihenstephan, Germany
©EHEDG*

7.2 Frequency License

CETECOM ICT Services GmbH

EC Identification number 0682

authorized by the German Government



to act as Notified Body in accordance with the R&TTE Directive 1999/5/EC of 09. March 1999.

CERTIFICATE EXPERT OPINION

Registration-No.: E814059R-EO
 Certificate Holder: Berthold Technologies GmbH & Co KG
 Calmbacher Strasse 22
 D-75323 Bad Wildbad

Product Designation: LB 465-xx, LB 466-xx, LB 565-xx, LB 566-xx

Product Description: Short Range Devices

Product Manufacturer: Berthold Technologies GmbH & Co KG
 Calmbacher Strasse 22
 D-75323 Bad Wildbad

Essential requirements	Specifications / Standards	Submitted documents	Result
EMC (R&TTE, Article 3.1b)	EN 55011:1998+A1:1999 (class A) EN 61000-6-2:2001	Test Report	conform
Radio spectrum (R&TTE, Article 3.2)	EN 300 440-1 V1.3.1 (2001-09) EN 300 440-2 V1.1.1 (2001-09)	Test Report	conform

Marking: The product shall be signed with CE and our notified body number as shown right hand.

CE 0682

The scope of this evaluation relates to the submitted documents only.
 The certificate is only valid in conjunction with the following number of annexes.

Number of annexes: 1

Saarbrücken, 24.06.2004
 Place, Date of Issue

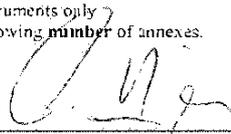
 Signed by Ernst Hussinger
 Notified Body



CETECOM ICT Services GmbH, Untertürkheimer Straße 6 10, D 66117 Saarbrücken, Germany
<http://www.cetecom.de>

CETECOM ICT Services GmbH



CERTIFICATE OF CONFORMITY

Registration-No.: E814059R-CC Number of annexes: ---

Certificate Holder: **Berthold Technologies GmbH & Co KG**
 Calmbacher Strasse 22
 D-75323 Bad Wildbad

Product Designation: **LB 465-xx, LB 466-xx, LB 565-xx, LB 566-xx**

Product Description: **Short Range Devices**
 (humidity sensor)

Product Manufacturer: **Berthold Technologies GmbH & Co KG**
 Calmbacher Strasse 22
 D-75323 Bad Wildbad

Specifications and test reports:

Specification	Test report no. & date	Name of test laboratory	Notes
EN 55011:1998+A1:1999 (class A) EN 61000-6-2:2001	2003-731-1182-REN dated Sept. 9, 2003	ELMAC GmbH	conform
EN 300 440-1 V1.3.1 (2001-09) EN 300 440-2 V1.1.1 (2001-09)	2-3389-01-01/03 dated May 14, 2004	CETECOM ICT	conform

Statement **This equipment fulfils the requirements or parts thereof in the above mentionend specifications.**

CETECOM ICT Services is authorized to act as Notified Body in accordance with the R&TTE Directive 1999/5/EC of 09. March 1999

Saarbrücken, 24.06.2004
 Place, Date of Issue

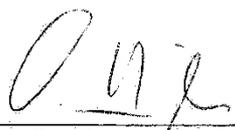
 Signed by Ernst Hüssinger
 Notified Body



CETECOM ICT Services GmbH, Untertürkheimer Straße 6-10, D-66117 Saarbrücken, Germany

CETECOM ICT Services GmbH



CERTIFICATE OF CONFORMITY

Registration-No.: **E815580V-CC** Number of annexes: ---

Certificate Holder: **BERTHOLD TECHNOLOGIES GmbH & Co KG**
Calmbacher Strasse 22
75323 Bad Wildbad
Germany

Product Designation: **Micro-Polar ++ LB 566-1x**
Micro-Polar Brix ++ LB 565-1x

Product Description: **Short Range Devices**
(humidity sensor)

Product Manufacturer: **BERTHOLD TECHNOLOGIES GmbH & Co KG**
Calmbacher Strasse 22
75323 Bad Wildbad
Germany

Specifications and test reports:

Specification	Test report no. & date	Name of test laboratory	Notes
EN 300 440-1 V1.4.1 (2007-08)	2-4837-01-02/07	CETECOM ICT	conform
EN 300 440-2 V1.2.1 (2007-08)	dated February 07, 2008		

Statement This equipment fulfils the requirements or parts thereof in the above mentionend specifications.

CETECOM ICT Services is authorized to act as Notified Body in accordance with the R&TTE Directive 1999/5/EC of 09. March 1999

Saarbrücken, 2008-12-05
 Place, Date of Issue

Signed by Ernst Hussinger
 Notified Body



CETECOM ICT Services GmbH, Untertürkheimer Straße 6-10, D-66117 Saarbrücken, Germany

CETECOM ICT Services GmbH

EC Identification Number 0682

authorized by the German Government



BNetzA-bS-02/51-52

to act as Notified Body in accordance with the R&TTE Directive 1999/5/EC of 9. March 1999.

EXPERT OPINION

Registration-No.: **E815580V-EO**
 Certificate Holder: **BERTHOLD TECHNOLOGIES GmbH & Co KG**
Calmbacher Strasse 22
75323 Bad Wildbad
Germany

Product Designation: **Micro-Polar ++ LB 566-1x**
Micro-Polar Brix ++ LB 565-1x

Product Description: **Short Range Devices**

Product Manufacturer: **BERTHOLD TECHNOLOGIES GmbH & Co KG**
Calmbacher Strasse 22
75323 Bad Wildbad
Germany

Essential requirements	Specifications / Standards	Submitted documents	Result
Radio spectrum (R&TTE, Article 3.2)	EN 300 440-1 V1.4.1 (2007-08) EN 300 440-2 V1.2.1 (2007-08)	Test Report	conform

Marking: **The product shall be signed with CE and our notified body number as shown right hand.**

CE 0682

The scope of this evaluation relates to the submitted documents only.
 The certificate is only valid in conjunction with the following **number** of annexes.

Number of annexes: **1**

Saarbrücken, 2008-12-05
 Place, Date of Issue

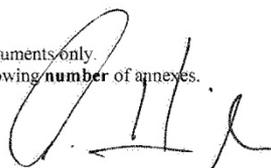
 Signed by Ernst Hussinger
 Notified Body

CETECOM ICT Services GmbH, Untertürkheimer Straße 6-10, D-66117 Saarbrücken, Germany
<http://www.cetecom-ict.de>

Technical Acceptance Certificate -
 CTC advanced GmbH (formerly CETECOM ICT Services GmbH)
 Untertuerkheimer Str. | 66117 | German | www.ctcadvanced.com

CTC advanced

member of RWTÜV group

Certificate Holder: BERTHOLD TECHNOLOGIES GMBH & CO. KG
 CALMBACHER STR. 22
 75323 BAD WILDBAD
 Germany

ISED Certification Number: 4777A-IC01X01

CTC Registration Number: 1865

OATS Facility ID Number: 3462C-1

OATS Facility: CTC advanced GmbH
 Untertuerkheimer Str. 6 -10
 66117 Saarbruecken
 Germany
 Phone: +49 681 598-0
 Fax: +49 681 598-8775
 Email: info@ctcadvanced.com

Product Description: Concentration, Dry Mass, Water, Density measuring system



BNNetzA-CAB-03/22-51
 authorized by the German Government to act as CAB in accordance with the MRA EU Canada of 1st November 1998.

Certification of equipment means only that the equipment has met the requirements of the above-noted specification. Licence applications, where applicable to use certified equipment, are acted on accordingly by the ISED issuing office and will depend on the existing radio environment, service and location of operation. This certificate is issued on condition that the holder complies and will continue to comply with the requirements and procedures issued by ISED. The equipment for which this certificate is issued shall not be manufactured, imported, distributed, leased, offered for sale or sold unless the equipment complies with the applicable technical specifications and procedures issued by ISED.

La certification du matériel signifie seulement que le matériel a satisfait aux exigences de la norme indiquée ci dessus. Les demandes de licences nécessaires pour l'utilisation du matériel certifié sont traitées en conséquence par le bureau de délivrance d'ISDE et dépendent des conditions radio ambiantes, du service et de l'emplacement d'exploitation. Le présent certificat est délivré à la condition que le titulaire satisfasse et continue de satisfaire aux exigences et aux procédures d'ISDE. Le matériel à l'égard duquel le présent certificat est délivré ne doit pas être fabriqué, importé, distribué, loué, mis en vente ou vendu à moins d'être conforme aux procédures et aux spécifications techniques applicables publiées par ISDE.

I hereby attest that the subject equipment was tested and found in compliance with the above-noted specification. J'atteste par la présente que le matériel a fait l'objet d'essai et jugé conforme à la spécification ci-dessus.



CTC advanced GmbH

cn=Gerald Schmidt, o=CTC advanced GmbH, ou=SCT-141216, email=gerald.schmidt@ctcadvanced.com, c=DE
 2017.09.08 10:20:11 +02'00'

Saarbrücken

Certification Body

CTC ||| **advanced**
member of RWTÜV group

Certificate Holder: BERTHOLD TECHNOLOGIES GMBH & CO. KG
CALMBACHER STR. 22
75323 BAD WILDBAD
Germany

ISED Certification Number: 4777A-IC01X12

CTC Registration Number: 1866

OATS Facility ID Number: 3462C-1

OATS Facility: CTC advanced GmbH
Untertuerkheimer Str. 6 -10
66117 Saarbruecken
Germany
Phone: +49 681 598-0
Fax: +49 681 598-8775
Email: info@ctcadvanced.com

Product Description: Concentration, Dry Mass, Water, Density measuring system



BNNetzA-CAB-03/22-51

authorized by the German Government to act as CAB in accordance with the MRA EU Canada of 1st November 1998.

Certification of equipment means only that the equipment has met the requirements of the above-noted specification. Licence applications, where applicable to use certified equipment, are acted on accordingly by the ISED issuing office and will depend on the existing radio environment, service and location of operation. This certificate is issued on condition that the holder complies and will continue to comply with the requirements and procedures issued by ISED. The equipment for which this certificate is issued shall not be manufactured, imported, distributed, leased, offered for sale or sold unless the equipment complies with the applicable technical specifications and procedures issued by ISED.

La certification du matériel signifie seulement que le matériel a satisfait aux exigences de la norme indiquée ci dessus. Les demandes de licences nécessaires pour l'utilisation du matériel certifié sont traitées en conséquence par le bureau de délivrance d'ISDE et dépendent des conditions radio ambiantes, du service et de l'emplacement d'exploitation. Le présent certificat est délivré à la condition que le titulaire satisfasse et continue de satisfaire aux exigences et aux procédures d'ISDE. Le matériel à l'égard duquel le présent certificat est délivré ne doit pas être fabriqué, importé, distribué, loué, mis en vente ou vendu à moins d'être conforme aux procédures et aux spécifications techniques applicables publiées par ISDE.

I hereby attest that the subject equipment was tested and found in compliance with the above-noted specification. J'atteste par la présente que le matériel a fait l'objet d'essai et jugé conforme à la spécification ci-dessus.



CTC advanced GmbH

Gerald Schmidt

cn=Gerald Schmidt, o=CTC advanced GmbH, ou=SCT-141216, email=gerald.schmidt@ctcadvanced.com, c=DE
2017.09.08 09:10:01 +02'00'

Saarbrücken

Certification Body

TCB

TCB

**GRANT OF EQUIPMENT
AUTHORIZATION**

**Certification
Issued Under the Authority of the
Federal Communications Commission**

By:

CTC advanced GmbH (former CETECOM ICT
Services GmbH
Untertuerkheimer Strasse 6-10
66117 Saarbruecken,
Germany

Date of Grant: 09/08/2017

Application Dated: 09/08/2017

**Berthold Technologies
Calmbacher Str. 22 75323 Bad Wildbad Germany
Bad Wildbad, 75323
Germany**

Attention: Dirk Moermann , Dr.

NOT TRANSFERABLE

EQUIPMENT AUTHORIZATION is hereby issued to the named GRANTEE, and is VALID ONLY for the equipment identified hereon for use under the Commission's Rules and Regulations listed below.

FCC IDENTIFIER: R9ZFCC01X01
Name of Grantee: Berthold Technologies
Equipment Class: Part 15 Field Disturbance Sensor
Notes: Concentration, Dry Mass, Water, Density measuring system

Grant Notes

PC II to add additional antennas.

FCC Rule Parts
15.245

Frequency Range (MHZ)
2441.0 - 2441.0

Output Watts

Frequency Tolerance

Emission Designator

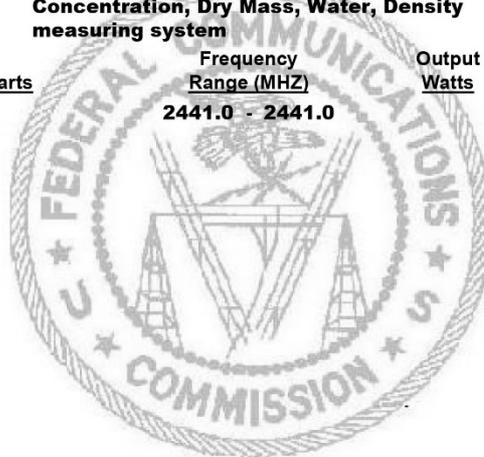

TCB

TCB

**GRANT OF EQUIPMENT
AUTHORIZATION**
Certification
Issued Under the Authority of the
Federal Communications Commission
By:

CTC advanced GmbH (former CETECOM ICT Services GmbH)
Untertuerkheimer Strasse 6-10
66117 Saarbruecken,
Germany

Date of Grant: 09/08/2017
Application Dated: 09/08/2017

Berthold Technologies
Calmbacher Str. 22 75323 Bad Wildbad Germany
Bad Wildbad, 75323
Germany

Attention: Dirk Moermann , Dr.

NOT TRANSFERABLE

EQUIPMENT AUTHORIZATION is hereby issued to the named GRANTEE, and is VALID ONLY for the equipment identified hereon for use under the Commission's Rules and Regulations listed below.

FCC IDENTIFIER: **R9ZFCC01X12**
Name of Grantee: **Berthold Technologies**
Equipment Class: Part 15 Field Disturbance Sensor
Notes: Concentration, Dry Mass, Water, Density measuring system

Grant Notes

FCC Rule Parts
15.245

Frequency
Range (MHZ)
2441.0 - 2441.0

Output
Watts

Frequency
Tolerance

Emission
Designator

PC II to add additional antennas.

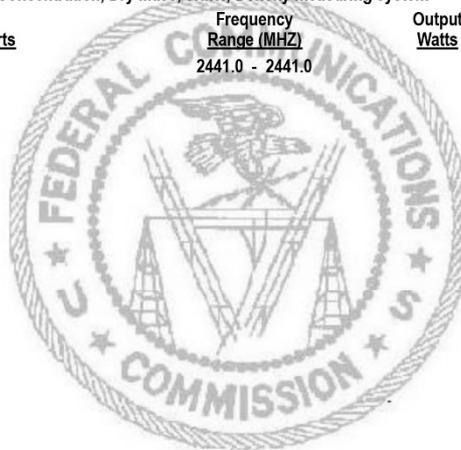

8.2 Electrical Wiring Diagram

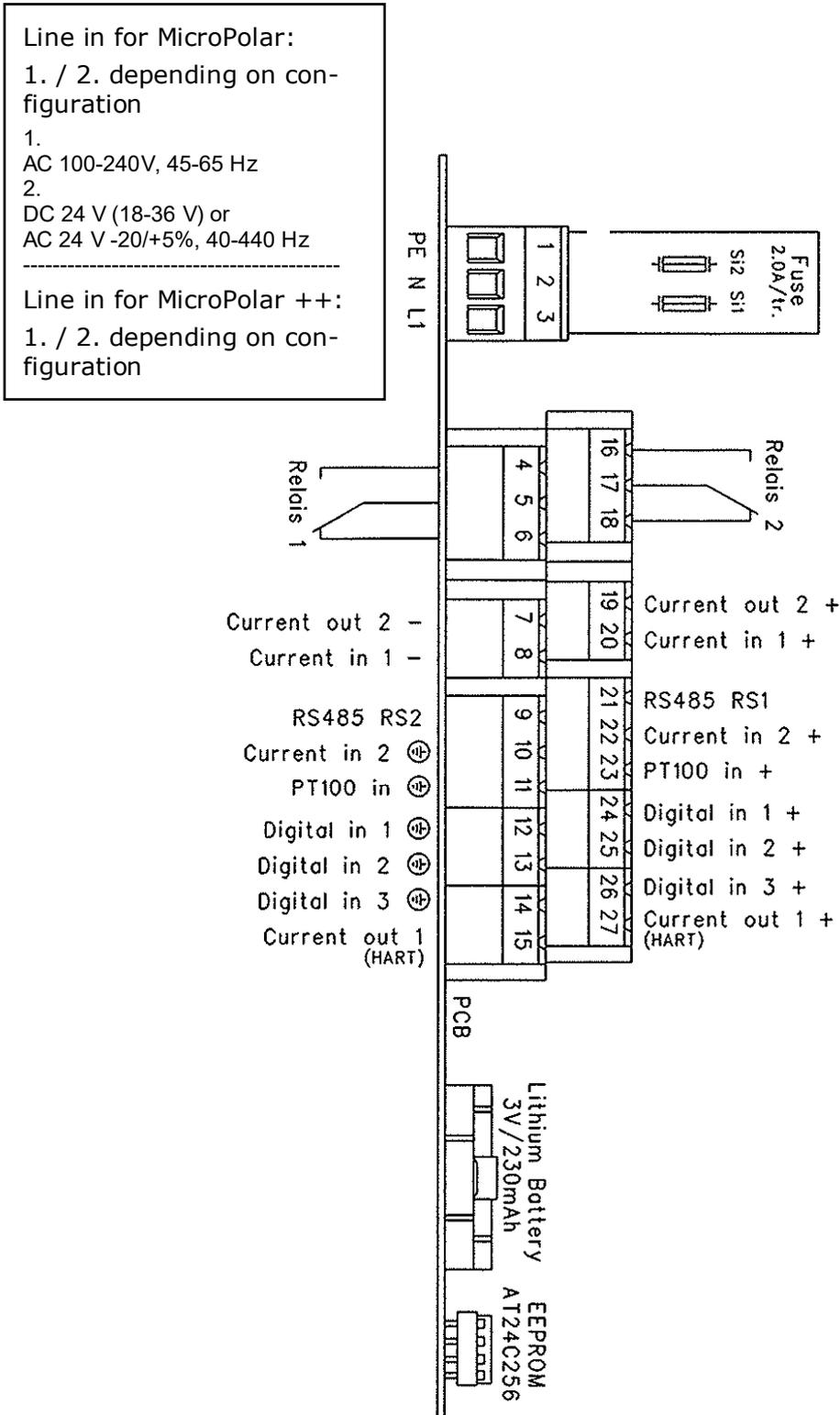

8.3 Dimensional Drawings FlowCell

8.3.1 Type LB 5660-102-00X FlowCell DN 50 Flange, FDA

Maßstab 3:10 (Gewicht)	Blatt 1	Rev. 01	Blatt 1
Werkstoff (Halbzeug) Roh.mtl.-Identif.	Bezeichnung LB 5660-102-00X FlowCell DN 50 VFL. FDA		
Überflaechen Innen- Aussen- Kanten ALU R9.3	Bezeichnung 07-JUL-17 Hirsch Freigeabe F602070112	Form A3	Rev. 01
Zeichnung 24.01.18 Pien	Zeichnung 24.01.18 Pien	BERTHOLD TECHNOLOGIES	
Rev. 01	Änderung	Datum	Name

Dateiname Modell: 66744-001-MI
Dateiname Zeichnung: 66744-001-MI

Diese Zeichnung darf ohne schriftliche Zustimmung weder kopiert noch dritten Personen mitgeteilt, noch anderweitig mündlich genutzt werden. Copyrights reserved

8.3.2 Type LB 5660-202-00X FlowCell DN 65 Flange, FDA

Dateiname Modell: 66744-002-M2
Dateiname Zeichnung: 66744-002-M2

Lagering-, Winkelmaße Form- u. Lager toleranzen ohne Toleranzangabe nach DIN ISO 2768-mk	Form- u. Ausson- Kanten 00.4 0.3 0.3	Oberflächen- Dateum 06-Sep-17 EG02070412	Überflachte Name Hirsch EG02070412	Maßstab Verstärkung () 3:10 (Gewicht)	Ng
Bearb. Freigabe 00.4 0.3 0.3	Datum 06-Sep-17 EG02070412	Name Hirsch EG02070412	Bezeichnung LB 5660-202-00X FlowCell DN 65 VFL, FDA	Identif.- 66744 M2	Blatt 1 1
Rev. 01 AEZ01800013 29.01.18 Pferl	Änderer Pferl	Datum 29.01.18 Pferl	Name Pferl	Identif.- 66744 M2	Rev. 01 Blatt 1

Diese Zeichnung darf ohne schriftliche Zustimmung weder kopiert noch Dritten Personen mitgeteilt, noch anderweitig in ähnlicher Weise genutzt werden. Copyrights reserved

8.3.4 Type LB 5660-402-00X FlowCell DN 100 Flange, FDA

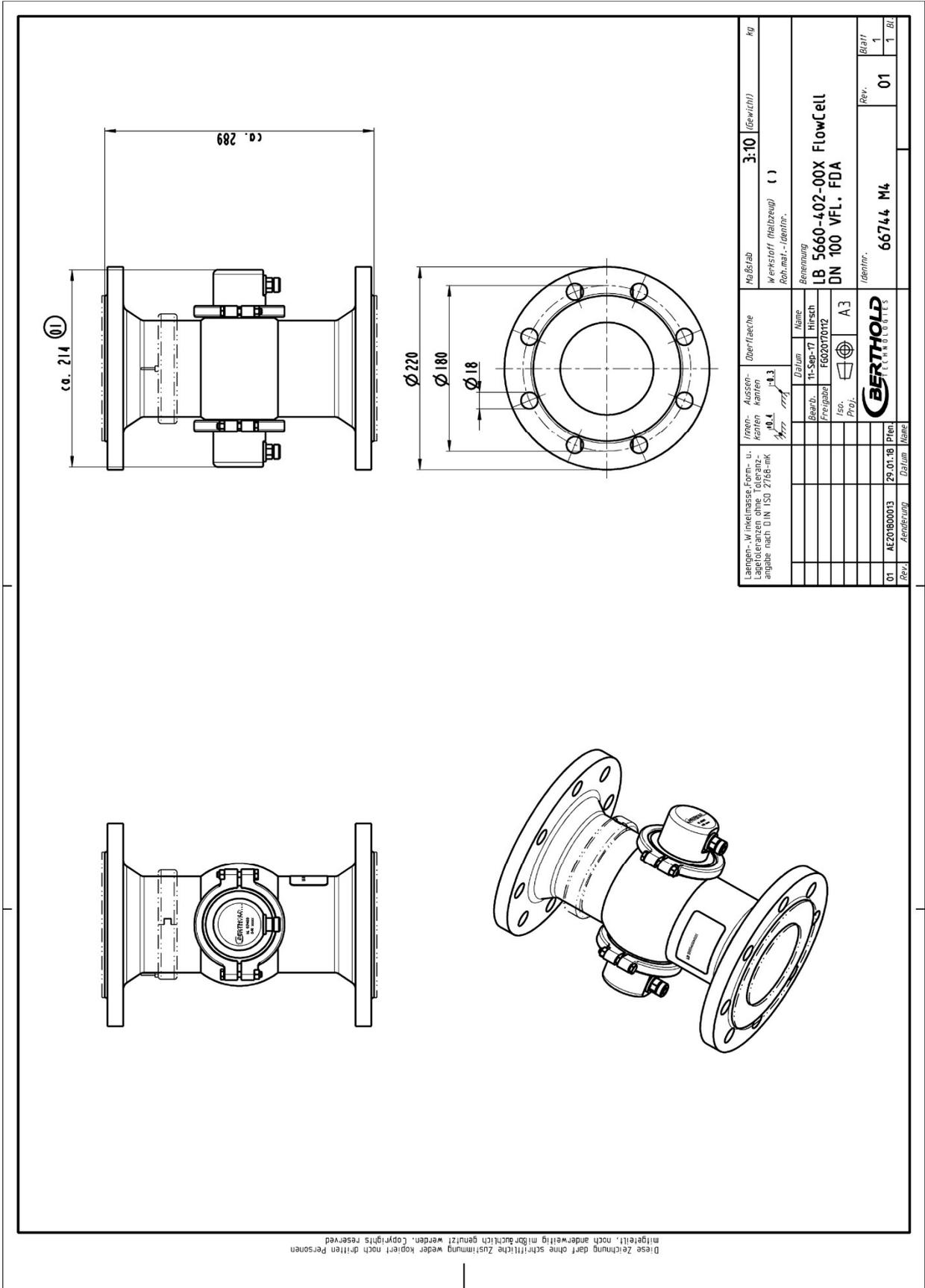

8.3.8 Type LB 5660-212-00X FlowCell DN 65 G-BS/M

Dateiname Modell: 66744-014-M14
Dateiname Zeichnung: 66744-014-M14

Längen-, Winkelmaße Form- u. Lagermaßen ohne Toleranzangabe nach DIN ISO 2768-mk		Ihren Anson- kanten		Oberfläche		Maßstab		kg	
		10.4		1.3		3:10 (Gewicht)			
		1:1		06-Sep-17		Werkstoff (Belzeup) ()			
		FG0207014		Name		Benennung			
		A3		A3		LB 5660-212-00X FlowCell			
		30.01.18		30.01.18		DN 65 G-BS/M			
		01		01		66744 M14			
		01		01		1			
		01		01		1			
		01		01		1			

Diese Zeichnung darf ohne schriftliche Zustimmung weder kopiert noch Dritten Personen mitgeteilt, noch anderweitig in ähnlicher Weise genutzt werden. Copyrights reserved

8.3.9 Type LB 5660-312-00X FlowCell DN 80 G-BS/M

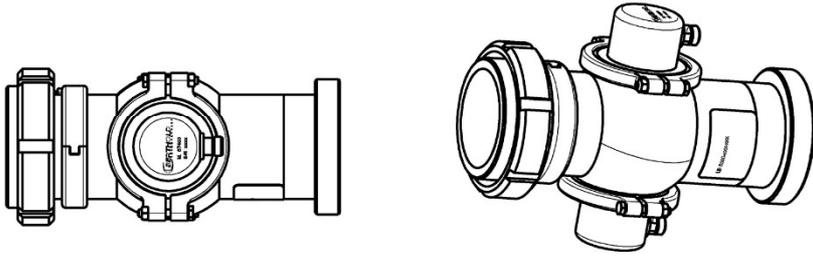

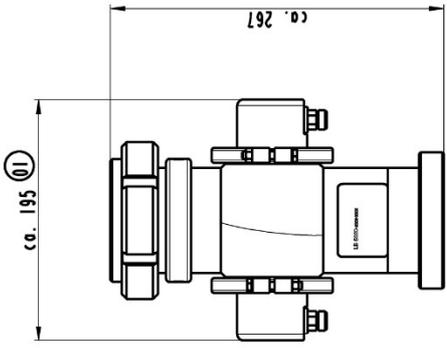

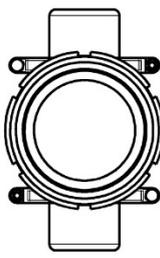

Diese Zeichnung darf ohne schriftliche Zustimmung weder kopiert noch dritten Personen mitgeteilt, noch anderweitig mißbräuchlich genutzt werden. Copyrights reserved

Längen-, Winkelmaße, Form- u. Oberflächenangaben in mm, Angabe nach DIN ISO 2768-mk	Maßstab 3:10 (Gewicht)	kg
Inngr. / Außen- / Form- / Flächen- / Prtz. / 10.1 / 10.3 / 10.3	Überflache Werkstoff (Halbzeug) () Benennung LB 5660-312-00X FlowCell DN 80 G-BS/M	Blatt 1 1 Bl.
Bearb. / 07-Sep-17 / Hirsch Freigegeben / FG02070114 Iso. / Prj. / A3	Datum 30.01.18 Name A3	Rev. / 01 Änderung / Datum / Name 66744 M15
		
Dateiname Modell: 66744-015-M15 Dateiname Zeichnung: 66744-015-M15		

8.4.2 Type LB 5650-02

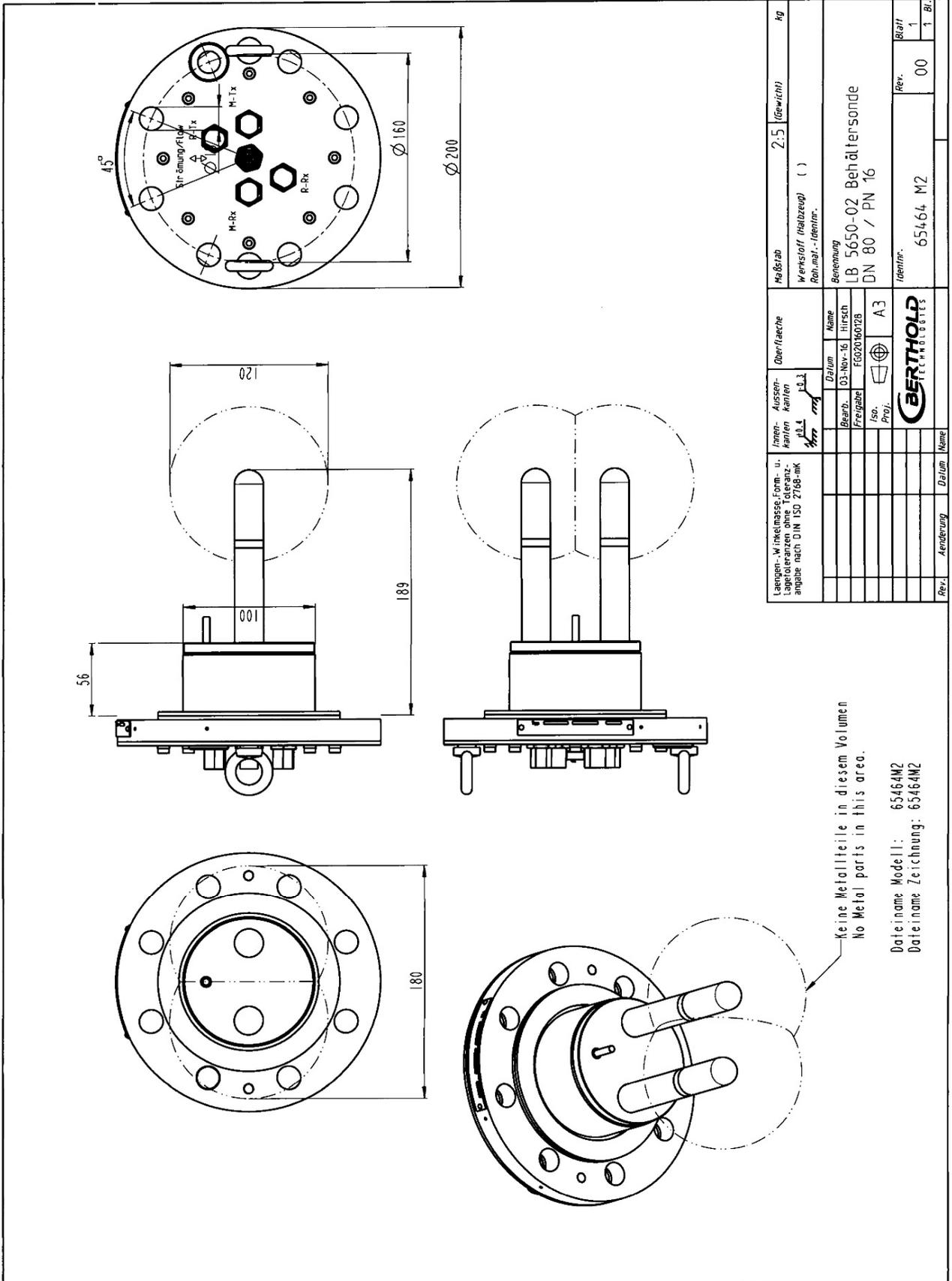

8.4.7 Installation Situation in Pipelines

Leerraum: Keine Metallteile in diesem Volumen
Empty space: No metal parts in this volume

Einbaulage ▽ Gravitation/gravity
Installation position in the pipe

Rohr Nennweite Pipe nominal size	A [mm]
min. DN 200	68
ab DN 250 or higher DN 250	53

Maßstab (drawing)	3:10
Werkstoff (material)	()
Reinigungs- / Identifizierung	
Benennung	LB 5650-01 Behältersonde DN65/PN6 Einbausituation in Rohrleitungen
Zeichnr.	4.1975M6
Rev.	00
Blatt	1
Bil.	1

Diese Zeichnung darf ohne schriftliche Zustimmung weder kopiert noch Dritten Personen mitgeteilt, noch anderweitig mit ähnlichem Zweck genutzt werden. Copyrights reserved



8.6 Assembly sheets for LB 5650 (Container probe)

MicroPolar with Container Probe - Installation In Crystallizer -

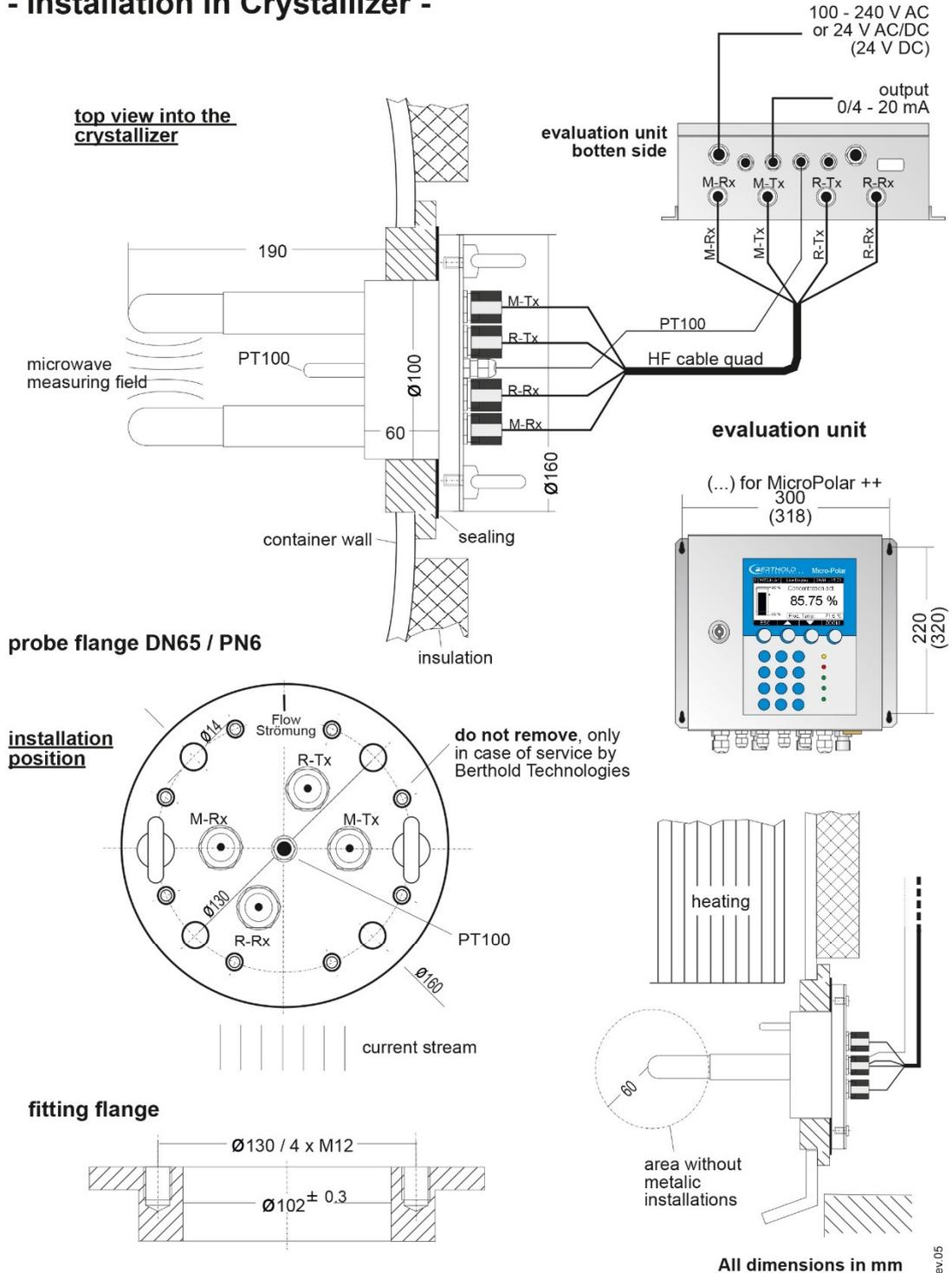

BERTHOLD TECHNOLOGIES GmbH & Co. KG . P.O. Box 100 163 . 75312 Bad Wildbad, Germany
Phone +49 7081 177-0 . Fax +49 7081 177-100 . industry@Berthold.com
www.Berthold.com

Id.-No. 41975T12 Rev.05

MicroPolar with Container Probe - Installation In Crystallizer -

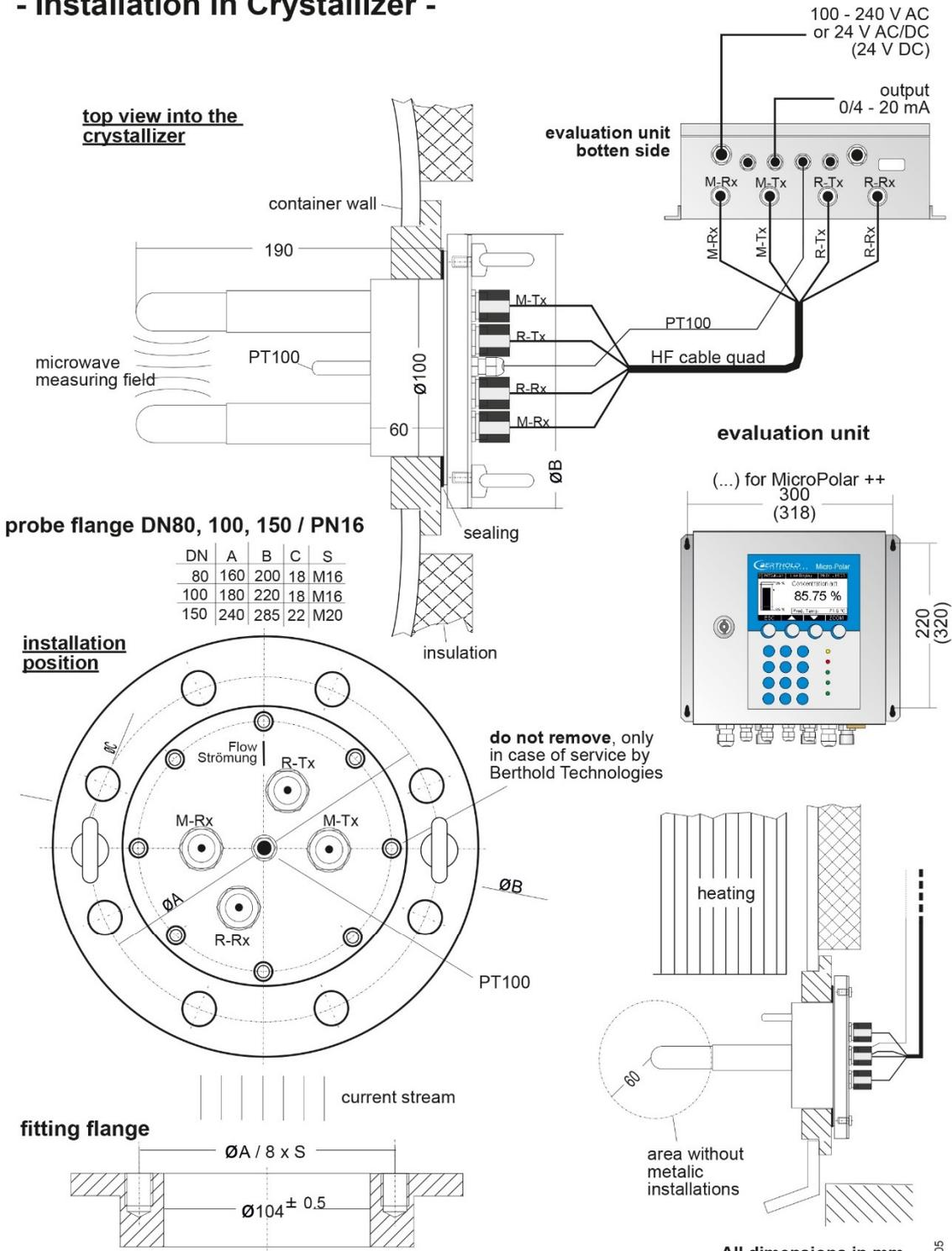

BERTHOLD TECHNOLOGIES GmbH & Co. KG . P.O. Box 100 163 . 75312 Bad Wildbad, Germany
Phone +49 7081 177-0 . Fax +49 7081 177-100 . industry@Berthold.com
www.Berthold.com

Id.-No. 41975T121 Rev.05

8.1 Assembly sheets for LB 5651 (Container flush probe)

MicroPolar with Container Flush Probe - Installation In Crystallizer -

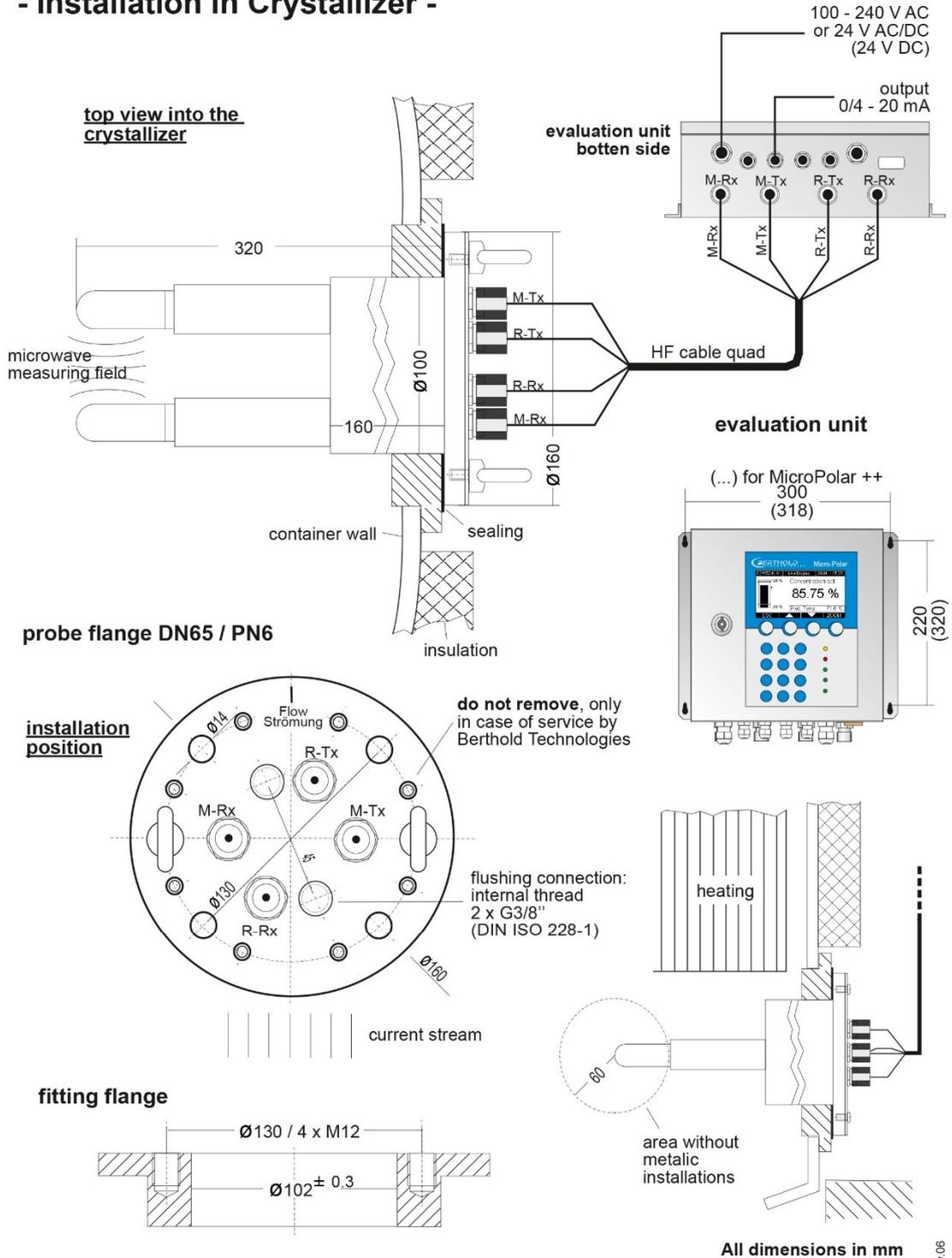

BERTHOLD TECHNOLOGIES GmbH & Co. KG . P.O. Box 100 163 . 75312 Bad Wildbad, Germany
Phone +49 7081 177-0 . Fax +49 7081 177-100 . industry@Berthold.com
www.Berthold.com

Id.-No. 41976T12 Rev.06

MicroPolar with Container Flush Probe - Installation In Crystallizer -

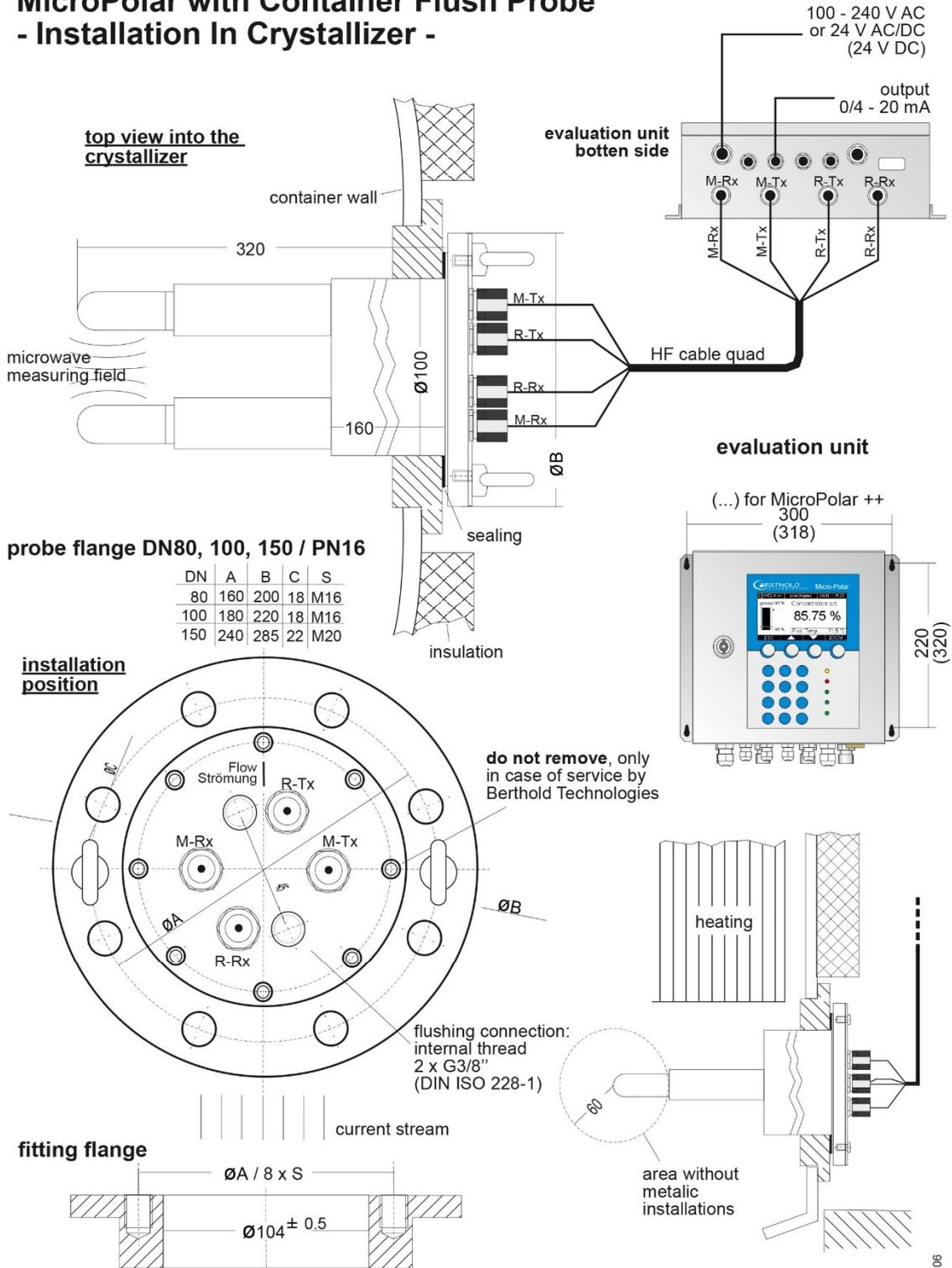

BERTHOLD TECHNOLOGIES GmbH & Co. KG . P.O. Box 100 163 . 75312 Bad Wildbad, Germany
Phone +49 7081 177-0 . Fax +49 7081 177-100 . industry@Berthold.com
www.Berthold.com

Id.-No. 41976T121 Rev.06

Index

A

Accuracy · 57
Adapter flange · 42
ASA flange adapter · 62
Assembly on a container · 34
Assembly on a pipeline · 33

B

Battery · 54

C

Cable installation · 39, 43
Calculation of measured values · 18
CE mark · 13
Compatible with foodstuffs · 28
Compensation · 19
Components · 21
Conductive materials · 19
Connector strip · 46
Container probe · 28
Container probe installation · 41

D

Data format RS232 · 67
Data transfer rate · 48
Device disposal · 51
Digital outputs · 48
Distance rail · 38
Distance to metal · 41

E

Evaluation unit · 23
Evaluation unit installation, flow cell · 38
EVU · 15

F

Factory setting · 15
Fitting flange · 41
Flat gasket · 41
Flow cell · 25
Flow cell installation · 36
Flush probe · 15, 30
Flushing parameters · 42
Format RS232 · 67
Frequency license · 12, 72
Fuses · 55

G

Gas inclusions · 14, 36

H

HF cable · 31
HF-cable quad · 31

I

Incrustation · 30
Installation depth · 41
Installation situation in pipelines · 102, 108
Instrument cleaning · 54

L

LED's · 24, 48
Limitations · 18

M

Mains fuses · 55

O

Overview container probes · 64

Overview flow cells · 61
Overview sealing washers · 64

P

Pipeline pressure · 36
Power radiation · 14
Power supply · 45
Principle of measurement · 17

R

Recycling passport · 51
Relay · 48
RS232 interface · 48

S

Safety summary · 7
Salt content · 14
Service instructions · 51
Setting up the evaluation unit, container probe · 43
Symbols · 7

Synchronization · 20

T

technical data · 57
Technical data HF cable · 65
Technical data sensors · 60
Technical drawings · 81
Temperature compensation · 19
Throughput calculation · 20
Transmission power · 57
Transport · 35

V

Vertical riser · 36

W

Warning · 7
Wear parts · 52
Wiring diagram · 83



**Concentration Meters
MicroPolar (++)
LB 566**

**User's Guide
Software Manual
41986BA2**

Rev. Nr.: 07, 03/2018

The units supplied should not be repaired by anyone other than Berthold Service engineers or technicians by Berthold.

In case of operation trouble, please address to our central service department (address see below).

The complete user's guide consists of the hardware manual and the software manual.

The **hardware manual** comprises the

- component description
- assembly instructions
- electrical installation description
- technical data
- certificates
- dimensional drawings

The **software manual** comprises the description of the

- operation
- software functions
- calibration
- error messages

The present manual is the software description.

Subject to changes without prior notice.

BERTHOLD TECHNOLOGIES GmbH & Co. KG	
Calmbacher Str. 22 · D-75323 Bad Wildbad	
Switchboard:	Service:
Phone +49 7081 177 0	Phone +49 7081 177 111
Fax +49 7081 177 100	Fax +49 7081 177 339
industry@Berthold.com	Service@Berthold.com
www.Berthold.com	

Table of Contents

	Page
Chapter 1. Safety Summary	7
Chapter 2. Communication with MicroPolar	9
Chapter 3. Getting Started Guide	11
Chapter 4. Software Functions	13
4.1 Information on the Menu Structure	13
4.2 Menu Structure	14
4.2.1 Start Menu	16
4.2.2 Diagnostic	16
4.2.3 Setup	18
4.2.4 Access Level	19
4.2.5 Language	19
4.2.6 Configuration	20
4.2.7 General Data	21
4.2.8 Measurement	21
4.2.9 Plausibility	22
4.2.10 Phase Measurement	23
4.2.11 Offline mode	23
4.2.12 Massflow	24
4.2.13 Calibration	25
4.2.14 System Adjust	25
4.2.15 Calibrate Concentration	26
4.2.16 Sampling	27
4.2.17 Sample Data (expanded)	28
4.2.18 Advanced	28
4.2.19 Calibration	29
4.2.20 Inputs / Outputs	30
4.2.21 Current Output	31
4.2.22 Current Out 1	31
4.2.23 Current Out 2	32
4.2.24 Current input	32
4.2.25 Current Input 1	33
4.2.26 Current Input 2	33
4.2.27 PT100	34
4.2.28 Digital Output	35
4.2.29 Digital Input	35
4.2.30 Service	37
4.3 Trend Display	39
Chapter 5. Configuration	41
5.1 Configuration Setup	41
5.1.1 General Data	41
5.1.2 Measurement	42
5.1.3 Plausibility	42
5.1.4 Microwave	43
5.1.5 Units	43
5.1.6 Marker	44
5.2 Start Calibration Coefficients	45
5.3 Configure Plausibility	46

Chapter 6. Calibration	47
6.1 System Adjust	47
6.1.1 Verifying the Reference Values	49
6.2 Sampling	49
6.2.1 Entering the Lab Values	51
6.3 Calibration	52
Chapter 7. Start-up of MicroPolar ++	53
Chapter 8. Calibration and Advanced	55
8.1 Plausibility Configuring Phi/Att Ratio	55
8.1.1 Phi/att Ratio	55
8.1.2 Process Recording	56
8.2 Adjusting the Calibration	58
8.3 Output of the Start-up Protocol	60
8.4 Calibration	61
8.4.1 Calibration with Two Concentrations	64
8.4.2 Calibration with Split Value	68
8.5 Typical Calibration Coefficients/Start Values	70
Chapter 9. Password	71
9.1 Password Forgotten	71
Chapter 10. Error Lists and Device States	73
10.1 Power failures	73
10.2 Temperature errors	73
10.3 Hardware failures	74
10.4 Sensor errors	75
10.5 Analog input range errors	75
10.6 Measurement range errors	76
10.7 Auxiliary measurement errors	76
10.8 Analog output range errors	77
10.9 Watchdog error	77
10.10 System errors	77
10.11 Density errors	77
10.12 Input Error	78
10.13 Device States	79
Chapter 11. Start-up Protocol	81
11.1 Example of Start-up Protocol	84
11.2 Sampling	89

Chapter 1. Safety Summary

Please observe all safety instructions in the *Hardware Manual*, especially those in *chapter 1 Safety Summary*.

NOTICE

Parameter settings

Never change the installation and the parameter settings without a full knowledge of these operating instructions, as well as a full knowledge of the behavior of the connected controller and the possible influence on the operating process to be controlled.

Chapter 2. Communication with MicroPolar

The communication with MicroPolar and MicroPolar ++ is carried out via 4 softkey buttons. The function of the individual buttons changes relative to the position in the menu. Values and texts are entered via an alphanumeric keypad. The instrument status is indicated by 5 LEDs.



TIP

Click on the help button **?** in the display footer to view useful information.

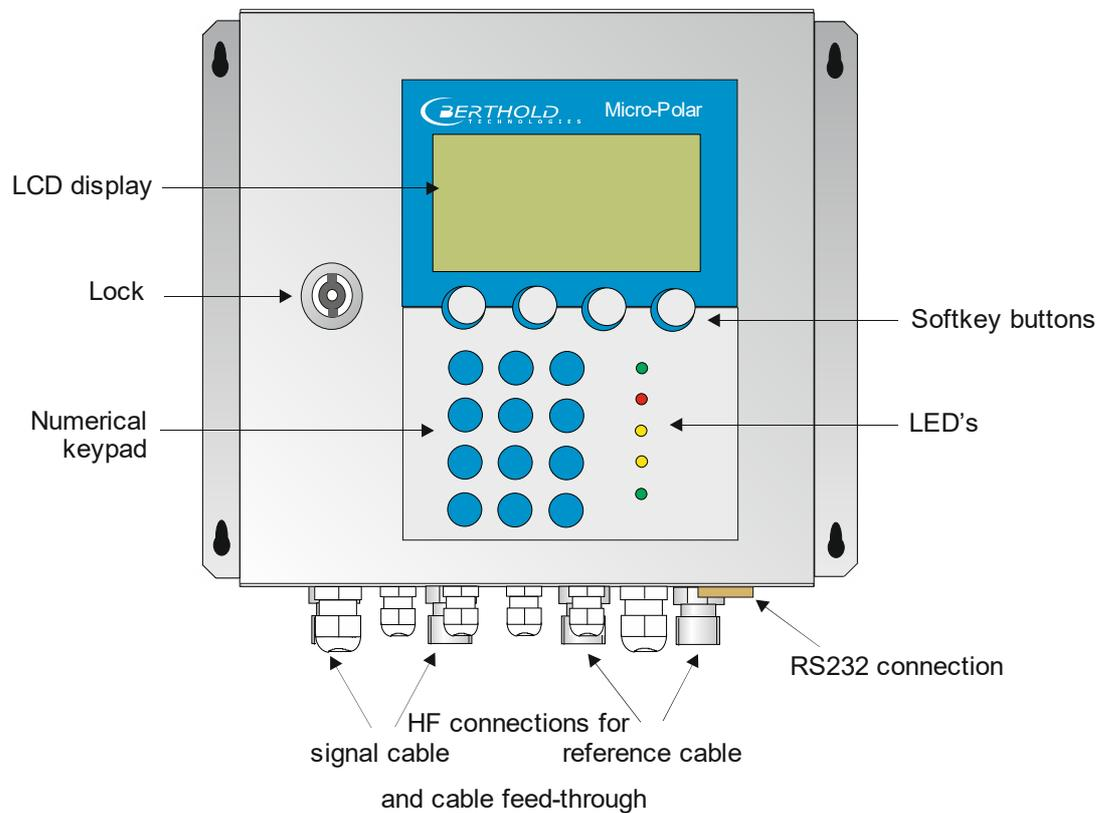

Chapter 3. Getting Started Guide

To get started, please carry out the steps described below one after the other.

Please read *chapter 8 Start-up of the MicroPolar ++* before you take the high dynamics version into operation.

Chapter 4 Software Functions describes all software functions and also serves as a reference guide.

1. Step

Configure the analog inputs as needed: Current inputs 1, 2 and PT100. See *chapter 4.2.22 Input / Output*.



TIP

All analog inputs and outputs have already been set in the factory. Therefore, no adjustment work is required during commissioning.

2. Step

Review and edit the software parameters of the application. Some parameters have already been set in the factory. Carry out the steps described in *chapter 5. Configuration*.

3. Step

Carry out the calibration with sampling, *chapter 6. Calibration Flow Cell / Container Probe* or *chapter 7. Calibration Conveyor Belt/Chute*

Temperature compensation is required only if the phase/attenuation will be clearly influenced by the product temperature; this is dependent on the product and water content.

4. Step

Configure the current outputs, digital in- and outputs as needed.

Chapter 4. Software Functions

4.1 Information on the Menu Structure

The menu structure on the following pages provides an overview of all functions of the LB 566. Using the **page numbers** indicated you can look up the function of the depicted window.

You have to enter a password to change from the **Read only** level to **User Mode**. The **Service level** is not accessible due to licensing regulations.

NOTICE

The analysis unit and the software contain functions which are not relevant for the measuring system LB 566 (++) and their measuring application.

It concerns the following functions:

- Load compensation
- Synchronizing the measuring devices

In the operation manual, these functions and the corresponding menus are not described.

4.2 Menu Structure

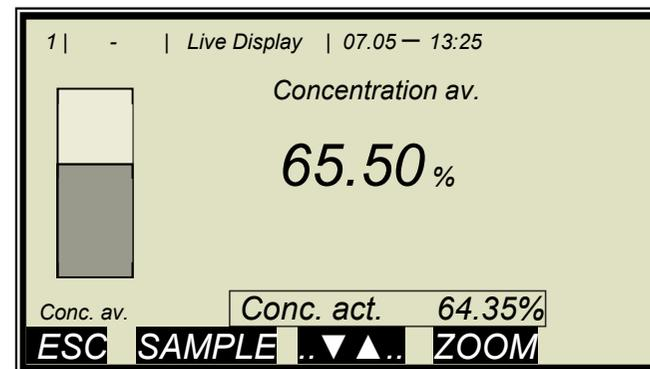
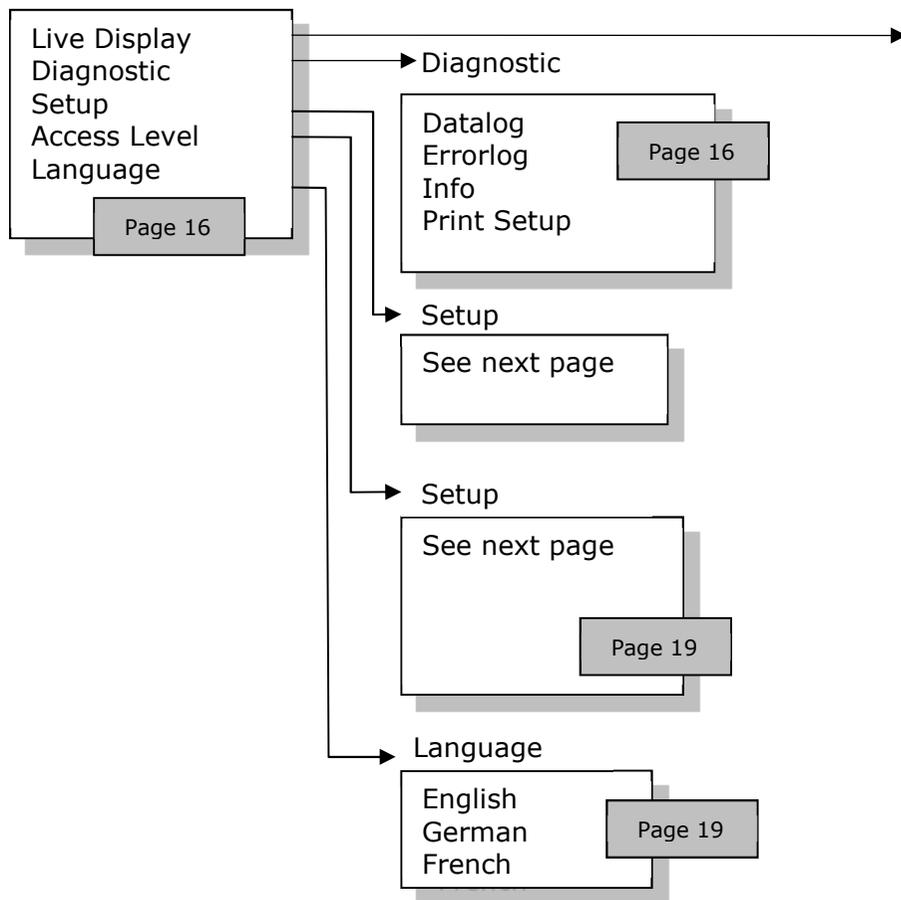

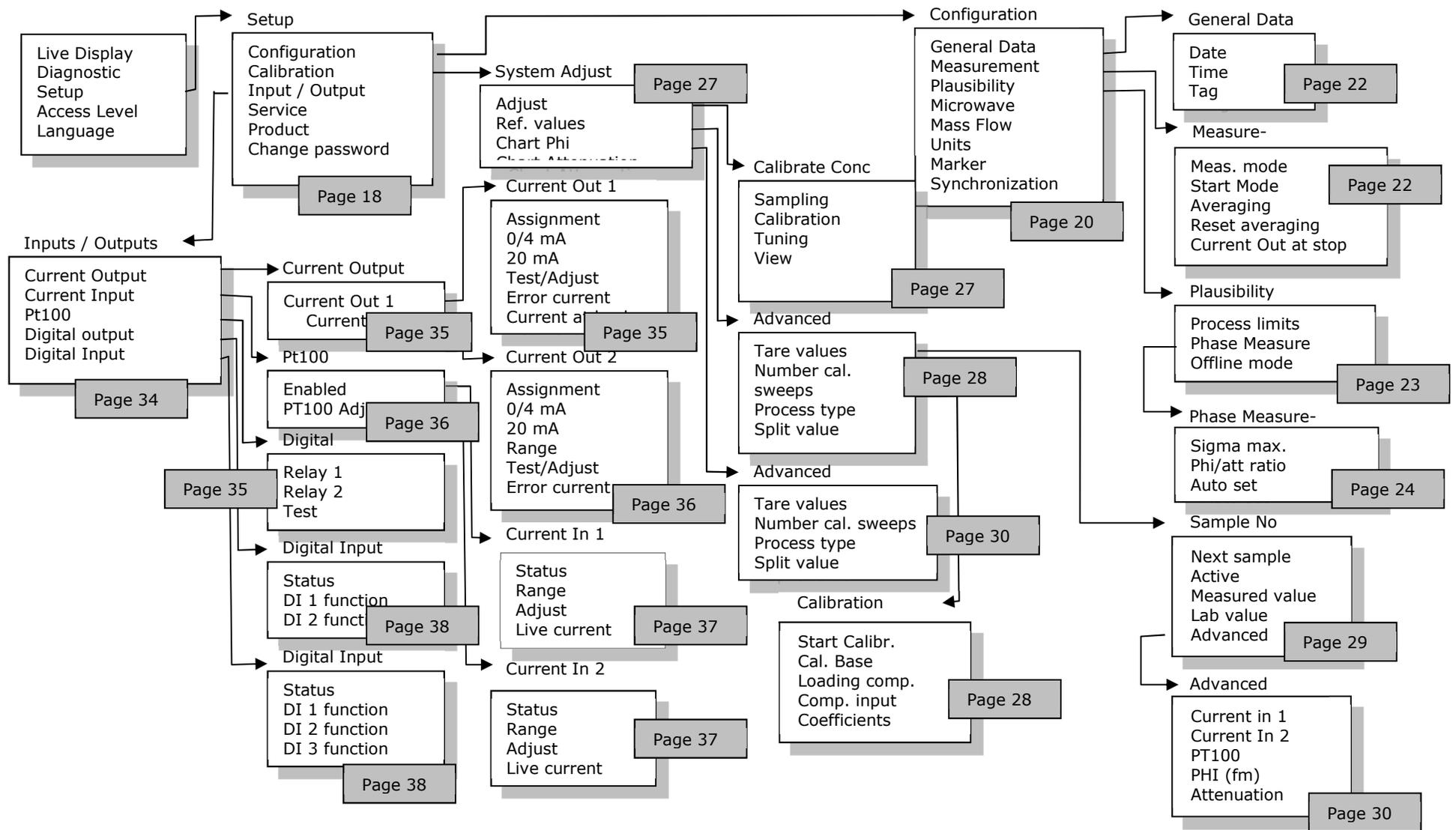

4.2.1 Start Menu



Live Display

Shows the live display.

Diagnostic:

This menu item contains the submenu items data logger, error log, device information and print setup.

Setup:

All necessary inputs for operation of the measuring system can be entered here.

Access level:

Select the access level.

Areas protected by passwords can be unlocked.

Language:

Select the dialog language.

4.2.2 Diagnostic

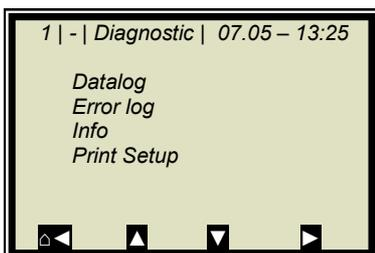

Datalog:

Datalog records the data corresponding to the contents of the serial data output RS232 and RS485 (see *Hardware Manual, chapter 6.6*).

All measured data of a measurement (sweep) are averaged over the averaging time (see below) and stored. This time is dependent on the selected log time. The contents of the datalog can be displayed on the live display, see *chapter 4.3 Trend Display*. Output as a text file is also possible by using RS232 and RS485, or the Memory Tool (optional accessory).

- Log type Disable
 single
 continuous
 stop at error
- Log time Logging period
 15 minutes to 3 days
- Restart log Clears the datalog and starts
 with the above setting
- Averaging time Obtained from log time
- Print log Printout of tables, output via
 RS232 and RS485, format see
 chapter 6.6 Hardware Manual

Change datalog settings:

If you change the log type from any to "single", the datalog will be cleared and you start again with the current setting. If you change all other log types and log times, the datalog will not be cleared and you continue with the new settings.

Behavior with stopped measurement:

If the measurement is stopped for some time during the datalog, then the measurement pause will be interpreted as log time in the log type "single". For all other log types, the measurement pause will be added to the log time.

Error log:

Shows the logged error. The last 20 error messages will be stored with date and time.

Info:

- Tag : ...
- Device type : LB 566
- Supplier : Berthold Technologies
- Manufacturer : Berthold Technologies
- Device no. : ...
- Production no. : ...-...
- Software Ver. : V...
- SW rev. date : ...

Print Setup:

Printout of the start-up protocol via RS232 and RS485. Format, contents and example see *chapter 11. Start-up Protocol*.

4.2.3 Setup

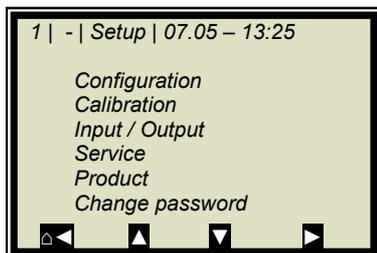

Configuration:

Setup of

- General data
- Measurement-specific data
- Plausibility data
- Microwave data
- Units
- Marker

Calibration:

- System Adjust
- Calibrate Conc
- Advanced

Input / Output:

- Current output
- Current input
- PT100
- Digital output
- Digital input

Service:

- Factory Setting
- General Reset
- Memory Tool (operation of the memory tool, optional accessory)
- Data Output (via RS232 and RS485, data contents can be selected)

Product:

Product selection (1-4); if you select another product, the product-specific data will be loaded: outputs, inputs and calibration.

When you select the products 2 to 4 for the first time, all settings and contents (e.g. system calibration, sampling table, datalog and calibration) of the current product will be copied to the new product.

Change password:

The password for the User Mode access level can be changed here.

For more information see *chapter 9. Password*.

4.2.4 Access Level

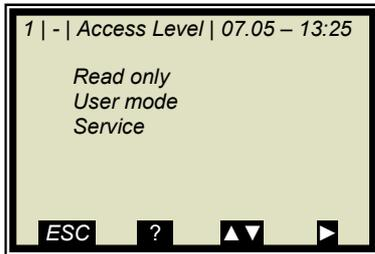

Read only:

In this mode, the measuring system can be protected against unauthorized access. You can exit this level only by entering a password. The measuring system cannot be started and stopped. You can go to Diagnostic and to Access Level only in the main menu.

User Mode:

- The user mode is the default mode and provides access to all user-relevant parameters.
- On the *Read only* level you have to enter a password.
- The password can be changed.

Service:

- This level is reserved for the service personnel.

4.2.5 Language

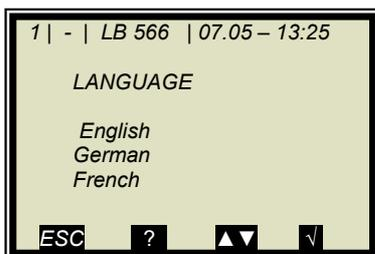

Language:

- Select the dialog language

4.2.6 Configuration

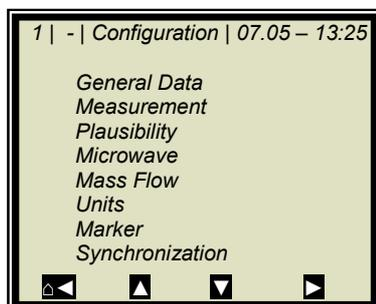

General Data:

- Enter date, time and tag

Measurement:

- Meas. Mode (batch/continuous)
- Start Mode (keyboard/external)
- Averaging (number of measured values used for averaging)
- Reset averaging (yes/no)
- Current output at stop

For more information please see *chapter 4.2.8 Measurement*

Plausibility:

- The process limits define the permissible range within which the actual concentration must be.
- The phase measurement is subject to a plausibility analysis, which can be set here.
- Enable and define the pause function

For more information please see *chapter 4.2.9 Plausibility*

Microwave:

Cable (enter the reference and signal cable length) For example, for 4 m HF cable quad, you have to enter 8 m for both lengths.

Mass flow:

If the density is measured in a pipeline application (unit of concentration = g/m^3 selected), the mass flow (throughput) can be output via current output 1 / 2 (in tons per hour).

Details on the mass flow see *chapter 4.2.12 Mass Flow*.

Units:

Depending on the configuration, different units can be selected for concentrations, current inputs and temperature. For the concentration (1 and 2) you can select: none, specific, %, %TS, °BX, g/L, g/cm^3 , °Be

For current input 1 you can select: none, specific, °C, °F, g/cm^3 , kg, t/h

For current input 2 you can select: none, specific, °C, °F, cm, m/s

For the PT100 input you can select: none, °C, °F

Markers:

Enter a value and a name (up to 5 characters) for the marker here. The presentation takes place in the live display and refers to the bar chart. To disable the marker, select a marker value outside of the chart limits or the current output limits.

4.2.7 General Data

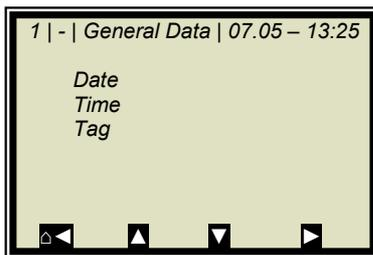

Date:

- Enter the current date

Time:

- Enter the current time

Tag:

- Enter the name of the measuring point. The tag (max. 8 characters) is displayed in the header on the display.

4.2.8 Measurement

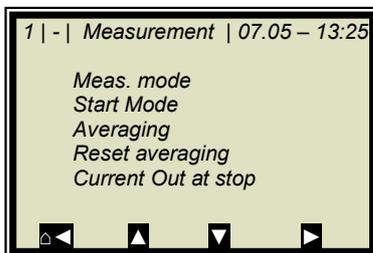

Meas. Mode:

Select continuous or batch. In Batch mode, an average value is calculated between start and stop. In Continuous mode, a moving averaging is calculated depending on the adjusted averaging number.

Start Mode:

The measurement device can be started or stopped via external terminals (digital input) or via keyboard.

Averaging:

Enter the number of averaging processes. This number indicates over how many measurements the concentration value is to be averaged (moving average). This is true only for the measuring mode Continuous.

Reset Averaging:

Reset averaging (yes/no) This refers to Batch and Continuous.

Current output at stop:

Select "0/4 mA" or "Hold". The selection defines how the current outputs behave with stopped measurement. This is true only for the measuring mode Continuous.

4.2.9 Plausibility

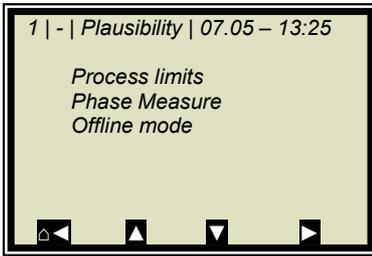

Process Limits:

Enter a permissible measuring range exceeding. If the concentration exceeds the range, the concentration average is put on hold and an error message is displayed (error state). The process limits are independent of the current output limits.

Phase Measure:

The phase is subject to a plausibility analysis. For more information please see *chapter 4.2.10 Phase Measurement*.

Offline mode:

Can be enabled or disabled. Switching variable is the attenuation; if the entered min. attenuation is not reached, the evaluation unit switches to the Offline mode:

- Current output drops to the lower current output limit (0/4 mA)
- Message on display
- RUN LED is flashing

For more information on the offline function see *chapter 4.2.11 Offline Mode*.

4.2.10 Phase Measurement

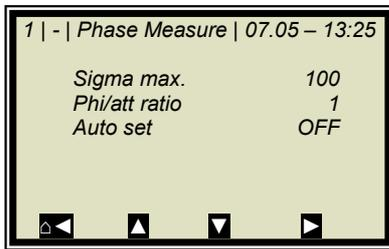

Sigma max.:

Here you set the maximum sigma of the regression Phase vs. Frequency. During normal measurement operation, sigma lies between 0 and 100. Default: Sigma = 100. With Sigma = 0 the plausibility is turned off.

Phi/att ratio:

The correlation between Phase and Attenuation is another plausibility criterion. Enter a fixed ratio value Phi/att. If you do not know it, you have to record it once, see description below "Auto set". The exact procedure is described in *chapter 8.1*.

Auto set:

The automatic measurement Phi/att ratio is turned on and off here. For more information about the function, see *chapter 8.1*.

4.2.11 Offline mode

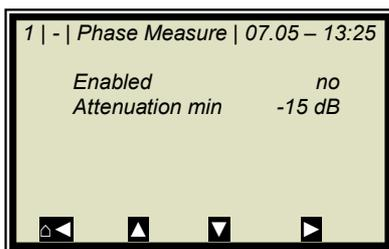

Description:

The offline mode is a software feature with allows detection of a certain product state (e.g. no product present). If the measured attenuation falls below a defined minimum attenuation, the evaluation unit switches to the offline mode. The device status for this mode is described in *chapter 10.4 Device States*.

Enabled:

The Offline mode is turned on and off.

Attenuation min:

Enter the minimum attenuation; if this value is not reached, the measurement switches to the offline mode and will quit this mode again as soon as the value is exceeded.

4.2.12 Massflow

The MASSFLOW menu appears only if two prerequisites have been fulfilled:

1. The density unit g/cm^3 is selected for the concentration.
2. Current input 2 is enabled and m/s has been selected as unit for current input 2.

For this case, the mass flow (throughput) in tons per hour can be displayed and output via the current output, based on the density reading with indication of the pipe cross-section or the internal pipe diameter.

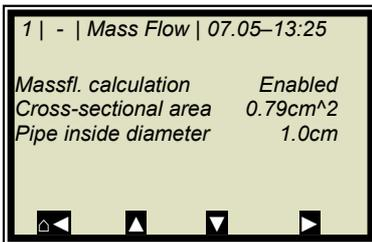

Massflow calculation:

Here the calculation is enabled or disabled.

Cross-sectional area:

Enter the cross-sectional area of the pipe.

Pipe inside diameter:

Enter the internal pipe diameter.

Comment: Only one entry is required: either the cross-sectional area or the internal pipe diameter, the other parameter will be calculated automatically.



IMPORTANT

The massflow calculation is performed only at varying product speed which must be entered via current input 2.

4.2.13 Calibration

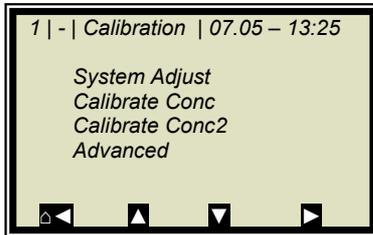

System Adjust:

System calibration is started here.
For details see *chapter 4.2.14 System Adjust*.

Calibrate Conc:

Opens the calibration menu of concentration 1.

Calibrate Conc2:

Opens the calibration menu of concentration 2.
The second concentration is displayed only if a second concentration is selected under menu | ADCANCED | PROCESS TYPE |.

Advanced:

Here you set the tare values, the number of sweeps when recording samples, the process type and the split value.
For more details see *chapter 4.2.18 Advanced*.

4.2.14 System Adjust

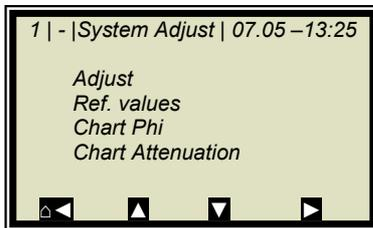

Adjust:

System adjustment is started. Phase and attenuation are set to zero, and thus, for example, all cable parameters are considered. This adjustment also forms the reference for the measurement.

The system adjustment (= reference measurement) must be carried out once.

Ref. values:

Upon completion of the reference measurement, the reference values for phase, attenuation, slope and Sigma can be output.

Chart Phi:

Shows the phase versus the frequency.

Chart Atten.:

Shows the attenuation versus the frequency.

A system adjustment will not delete the datalog (see *chapter 4.2.2 Diagnostic*).

4.2.15 Calibrate Concentration

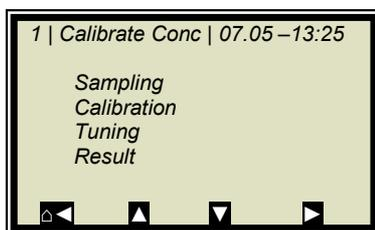
**Sampling:**

Shows all measured samples and entered lab values.

Calibration:

Here

- you select the calibration parameters, the temperature and loading compensation
- the calibration coefficients are calculated automatically
- the calibration coefficients are displayed

For more information see *chapter 4.2.19 Calibration*.

Tuning:

Subsequent correction of the reading is possible by entering a factor and an offset.

Calculation is carried out according to the following formula:

Eq. 4-1:

$$\text{Corrected display} = \text{Display} * \text{Factor} + \text{Offset}$$

Result:

Presentation of calibration curve, display of correlation and coefficients.

4.2.16 Sampling

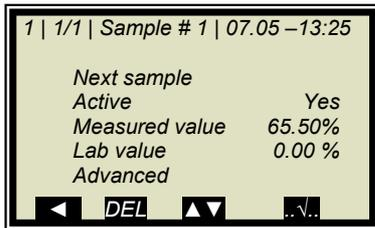

The header includes the following information (from left to right):

- Product no.
- Current table position / Total number of entries
- Sample no. of current table position
- Date and time of sampling

Up to 30 sample entries are possible. The sample can be assigned to the lab value either via the sample no. or through data/time. The sample no. is assigned on a continuous basis. If a sample is deleted, the sample no. will not be assigned a second time. Up to 999 sample numbers are available. Only if all numbers have been assigned, you may assign a number for the second time; you will be alerted accordingly by a message on the display.

Next sample:

Continue with the next sample.

Active:

You can choose if this sample should be taken into account in the calibration.

Measured value:

Display of the measured values, calculated with the actual coefficient.

Lab value:

Entry position for the lab value.

Advanced:

Switches to the next data page.

Delete:

Briefly push the softkey to delete the indicated sample entry. Push this key for a longer time to delete all sample entries.

4.2.17 Sample Data (expanded)

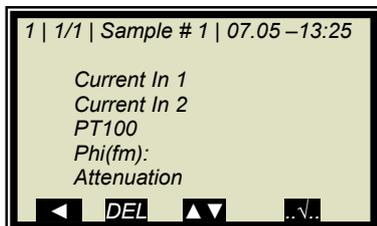

Current In 1:

Editable display of the first compensation input.

Current In 2:

Editable display of the second compensation input.

PT100:

Editable display of the PT100 input.

Phi(fm):

Not editable display of the measured phase.

Attenuation:

Not editable display of the measured attenuation.

4.2.18 Advanced

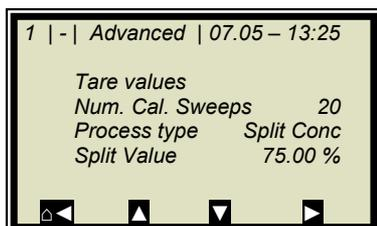

Tare values:

Option to enter tare values for phase and attenuation. The tare values are added to the phase and/or the attenuation prior to calibration. The calculation is carried out as follows:

Eq. 4-2 and 4-3

$$\text{Phase} = \text{Phase}_{\text{meas}} - \text{Phi Tare}$$

$$\text{Attenuation} = \text{Attenuation}_{\text{meas}} - \text{Phi Tare}$$

Number of Calibration Sweeps:

Freely adjustable number of sweeps over which a calibration point (in the course of automatic sample measurement) will be averaged.

Process Type:

Select the operation mode:

- one concentration [1 measuring range]
- two concentrations [2 measuring ranges]
- split concentration [1 measuring range with switching point (split value) for coefficient switchover].

Split Value:

Setting of the switching point on a value basis.

4.2.19 Calibration

Calibration is performed using the following formula:

Eq. 4-4

$$\text{Measured value} = A \cdot \text{Phase} + B \cdot \text{Attenuation} + C + D \cdot \text{PT100} + E \cdot \text{Input1} + F \cdot \text{Input2} + G \cdot \text{Load}$$

where:

Meas. value	Concentration / Moisture / Dry mass / Density
A	Phase coefficient
B	Attenuation coefficient
C	Offset
D	Compensation coefficient for PT100 input
E	Compensation coefficient for current input 1
F	Compensation coefficient for current input 2
G	Compensation coefficient for loading

The coefficients can be entered manually or calculated automatically from the entries of the sample table.

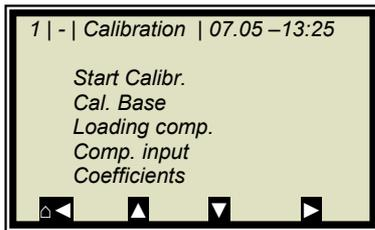

Start Calibr.

Starts the calibration using the parameters set and the coefficients are calculated automatically from the entries of the sample table.

Cal. Base

Selection of microwave signals, which are taken into account for the calibration. The following parameters can be set:

- Phase
- Attenuation
- Phase and attenuation

Default: Phase

Compensation Input

Here you can select the analog inputs (PT100, current input 1 and 2) required for compensation. Depending on the enabled analog inputs, the following options can be selected:

- None
- In1
- In1 + In2
- In1 + PT100
- In1 + In2 + PT100
- In2
- In2 + PT100
- PT100

Coefficients:

Here all coefficients can be entered directly, e.g. start coefficient.

The automatically calculated coefficients are also stored here. Coefficients that are not used are set to zero.

4.2.20 Inputs / Outputs

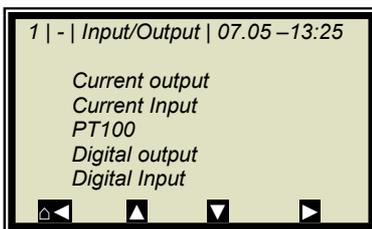

Current Output:

Both outputs can be adjusted, assigned and set up on the selected level.

Current Input:

Activation level of current input, calibration and display of the live current signal.

PT100:

Here you can enable and adjust a connected PT100. Display of the actual temperature signal.

Digital Output:

Allocation of relays 1 and 2 and test function.

Digital Input:

Status control and assignment of the digital inputs.

4.2.21 Current Output

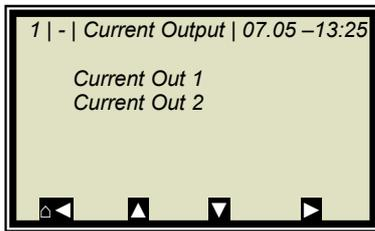

i IMPORTANT

If a measurement is running, enabling a current input which is not used or not adjusted may cause an error.

4.2.22 Current Out 1

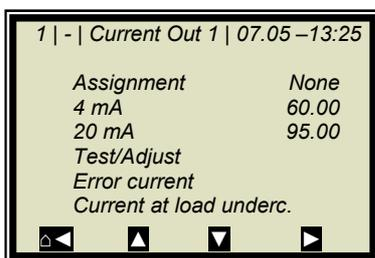

Assignment:

The following signals can be assigned to the current output:

- None
- Concentration
- Concentration 2 (if active)
- Current input 1 or 2 (if active)
- PT100 (if active)

4 mA:

Display value assigned to the 4 mA value.

20 mA:

Display value assigned to the 20 mA value.



TIP

Current output 1 only 4 - 20mA possible

If the current output limit is exceeded, the measurement switches to the warning state, see *chapter 10.4 Device States*.

Test/Adjust:

Current test, calibration and display of live current.



i IMPORTANT

The measurement should be stopped for test function.

To check the current loop and possibly connected remote displays, you can set a current between 4 and 20 mA via the test function. If you quit the test function, the system automatically switches back to the live current.

Error current:

If the measurement switches to the fault state, a fault current is output via the current output; this can be set here.

- 22 mA
- 3.5mA
- Hold
- Value (selectable)

4.2.23 Current Out 2

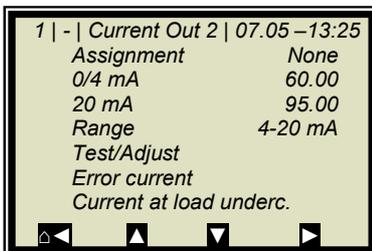

All functions same as current output 1



TIP

Current output 2 can either be set to 0/4 or to 20 mA.

Range:

Change the current output

- 0 - 20mA
- 4 - 20mA

4.2.24 Current input

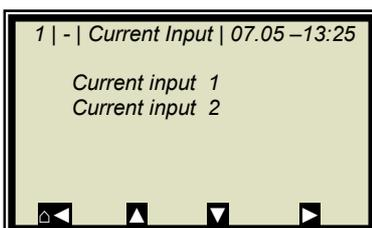

Current In 1:

When selected, change to the activation and calibration menu.

Current In 2:

As described above.

4.2.25 Current Input 1

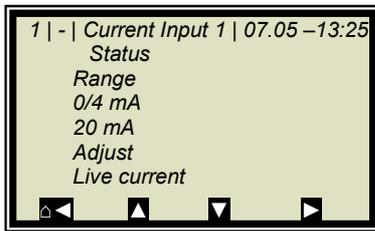

Status:

Select yes/no to enable or disable the current input.

Range:

Change the current output

- 0 - 20mA
- 4 - 20mA

0/4 mA:

Display value assigned to 0/4 mA value.

20 mA:

Display value assigned to the 20 mA value.

Adjust:

Follow the instructions on the display.

Live current:

Display of the live current signal.

4.2.26 Current Input 2

Settings correspond to current input 1.

4.2.27 PT100

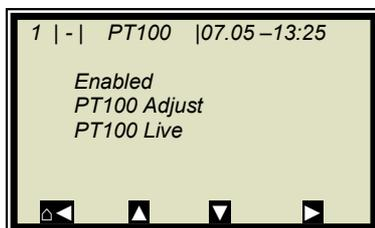
**Enabled:**

If a PT100 is connected, the input has to be enabled first.

**IMPORTANT**

If a measurement is running, enabling a PT100 input which is not used or not adjusted may cause an error.

PT100 Adjust:

You need a 100 Ohm and a 138.5 Ohm resistance. Follow the instructions on the display.

PT100 Live:

Display of the live temperature.

Set and enabled same as input 1.

4.2.28 Digital Output

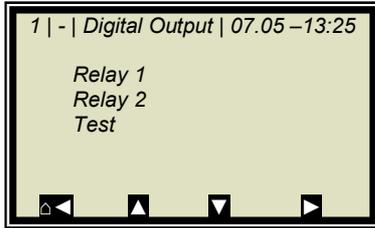

The meter has two relays. Relay 1 is linked with LED signal 1 and relay 2 with LED signal 2.

Relay 1:

Different functions can be assigned to relay 1:

- None
- Error
- Hold
- No product
- Alarm min
- Alarm max
- Current at load undercut

Function	Description
None	Relay and LED function disabled
Error	In case of error, relay and LED will be set.
Hold	If Hold function is enabled, relay and LED will be set.
Offline	If the evaluation unit is in the Offline mode, this will be signaled via the relay and LED.
Alarm min.	The relay switches if the value falls below the limit value to be set.
Alarm max.	The relay switches if the value exceeds the limit value to be set.

Relay 2:

Same assignments possible as above.

Test:

The switching status of the relays can be set here and checked at the respective terminals.

4.2.29 Digital Input

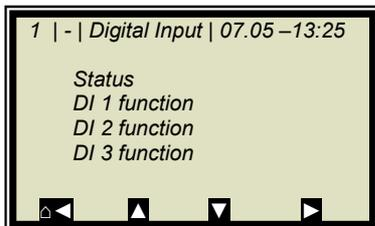

The meter has 3 digital inputs to which different functions can be assigned.

Status:

Shows the status of the input circuit

- open/closed

DI 1 Function

The following functions can be assigned to DI 1:

- None
- Start (external start)

DI 2 Function

The following functions can be assigned to DI 2:

- None
- Hold (averaging is stopped)
- Product (external product selection)

DI 3 Function

Assignments for DI 3:

- None
- Sample (external control of sampling)
- Product (external product selection)

For external start function, the start function has to be set to **External** in the **Measurement** menu window.

Hold means that averaging is stopped, but the measurement continues to run.

Sample means that sampling is started by closing the contact.

Product means that another product is selected by closing the contact (product 1 to 4).

**TIP**

If you select a product for the first time (product 2 to 4), all settings and contents of the current product will be copied to the new product, including:

- Configuration data
 - System adjust
 - Calibration data (including sampling table)
 - Input/Output definitions
-

To switch over all 4 products, DI 3 also has to be set to product. Please take the terminal configuration from the table below.

Terminals	DI 2 13 / 25	DI 3 14 / 26
Product 1	open	open
Product 2	closed	open
Product 3	open	closed
Product 4	closed	closed

4.2.30 Service

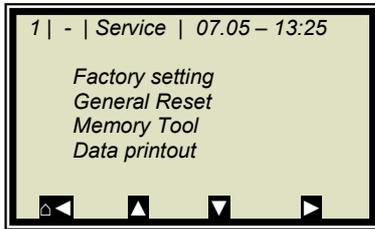

Factory setting and General reset:

See table on the next side.

Memory Tool:

Refers to the communication with the external memory tool (optional accessory). Data transfer takes place via the 9-pole SubD-connector on the bottom of the instrument.

- Save parameters: All instrument parameters for all products will be saved to the memory tool.
- Load parameters: All instrument parameters stored on the memory tool will be loaded onto the evaluation unit. All operating parameters in the evaluation unit will be deleted.
- Save datalog: The datalog will be saved to the memory tool.
- Save log: The start-up log will be saved to the memory tool.

NOTICE

The concentration average value is put on hold during communication with the memory tool. Thus, the measured value via current output is also put on hold!

Data printout:

All measured values are output for each measurement via the serial data interfaces RS232 and RS485. The output can be set as follows:

- None (disabled)
- Row (data transfer, see *Hardware Manual, chapter 6.4*)
- Table (microwave data for each frequency point)
- Row and table

"Row" is defaulted.

	Factory setting	General reset
Language selection	unchanged	unchanged
Access level	unchanged	default: User mode
Measurement	stopped	stopped
Password	unchanged	default: PASS1
Product selection	unchanged	all products deleted
Error log	not deleted	deleted
Data log	not deleted, default settings	deleted, default settings
System Adjust	not deleted	deleted
Cable length	unchanged	default
Sampling	not deleted	deleted
TAG label	default	default
All parameters on menu: Measurement Plausibility Marker Units	default	default
Calibration coefficients	default	default
All settings for the analog and digital inputs and outputs	default	default
Adjustment of the analog inputs and outputs	unchanged	unchanged
Comment:	affects only the current product	affects all products (P1 to P4)
-		

*Default: Default values, see chapter 11.1 Example Start-up Protocol

4.3 Trend Display

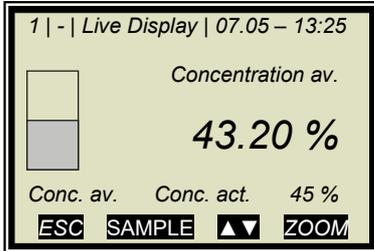

Push the **ZOOM** button to enlarge the measurement value which is surrounded by a frame.

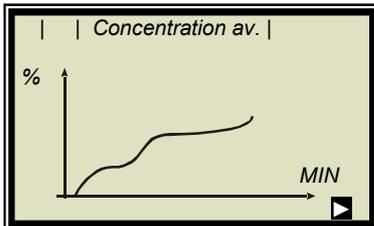

By pushing the **ZOOM** button for a longer time, the enlarged measurement value will be displayed as trend over the entire display.

The trend display corresponds to the contents of the datalog. The datalog has to be enabled for the trend display.

NOTICE

As long as the trend builds up, the measured value and/or the current output are put on hold!

Chapter 5. Configuration

Before doing any calibration work, you have to enable and configure the required analog inputs and check and, if necessary, correct the configuration parameters.

If the required inputs are not enabled, some menus are not displayed and a proper configuration and calibration is not possible under certain circumstances. The current outputs, digital outputs can be enabled and configured after the calibration.

The measuring system includes two separate floating current outputs.

5.1 Configuration Setup

Starting from the main menu, go to the display shown on the left via | SETUP |

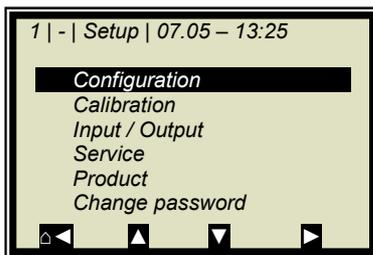

➤ CONFIGURATION

5.1.1 General Data

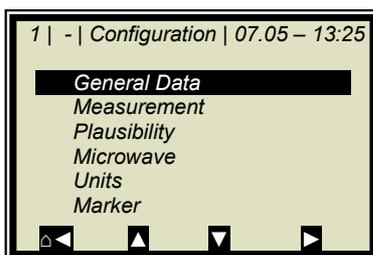

➤ GENERAL DATA

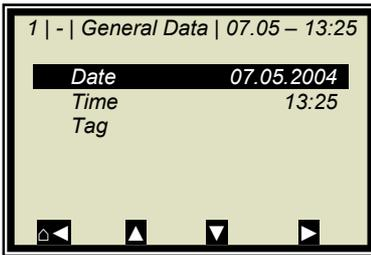
**Example:**

Select the respective entry, edit and store it.

➤ DATE

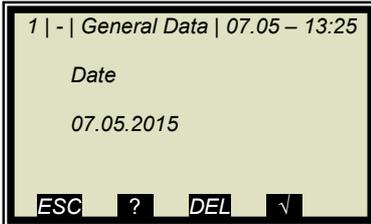

Push **DEL** to delete the entry and then enter the new date.
Push **✓** to confirm and store the changed date.

**TIP**

The colon for the time input (e.g. 13:25) is invoked by pushing the button [.].

5.1.2 Measurement

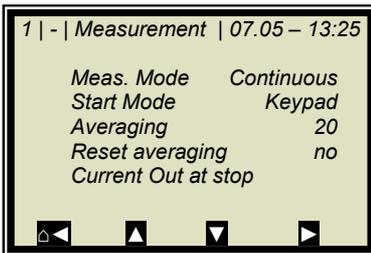

You have to check the settings on this display and adapt them to the measurement conditions.

Averaging over 20 measurements is a good choice as a rule.

5.1.3 Plausibility

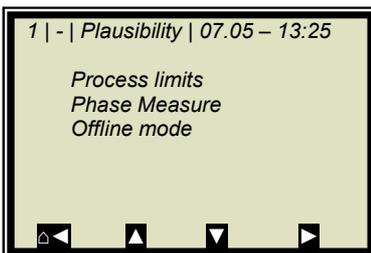

The **process limits** need to be adjusted. Allow exceeding of the measuring by $\pm 5\%$ absolute.

Example: The measuring range is 65-95% TS. Enter 60-100% TS as process limit.

The process limits are independent of the current output limits.

For setup of the **phase measurement**, see *chapter 5.3 Configuring Plausibility*.

The **Offline mode** is deactivated by default. Take this function into operation, when necessary, only when the measuring system was put into operation without errors. Refer to the description in *chapter 4.2.11 Offline Mode*.

5.1.4 Microwave

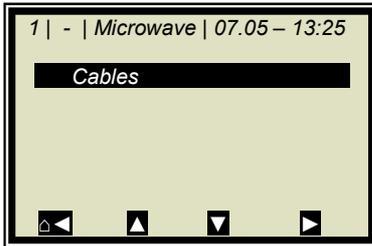

➤ CABLES

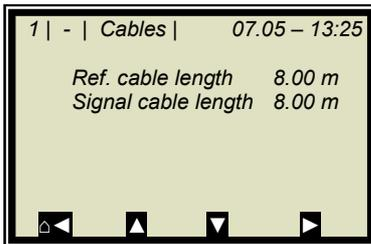

If the factory-set cable lengths do not match the actual geometry conditions, you have to correct the values.

Example: For a 4 m long HF quad cable, enter 8 m for the reference and signal cable length. The input value corresponds to twice the quad cable length.

5.1.5 Units

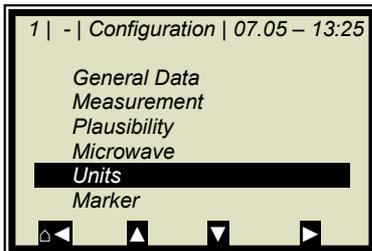

Set the units to the desired dimension.

➤ UNITS

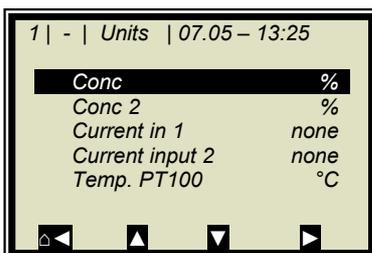

The units of the concentrations (conc 1 and 2) and those of the enabled analog inputs can be selected.

➤ CONC / CONC 2

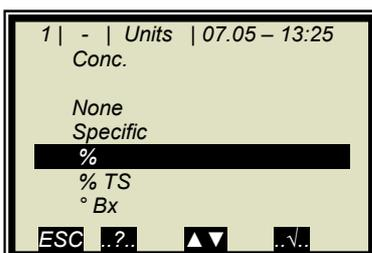

Different units can be set for both concentrations.

➤ %

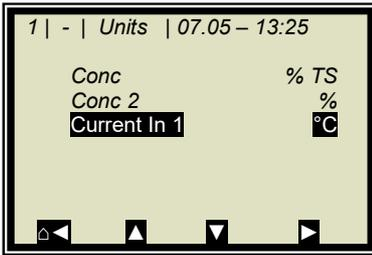

➤ CURRENT IN 1

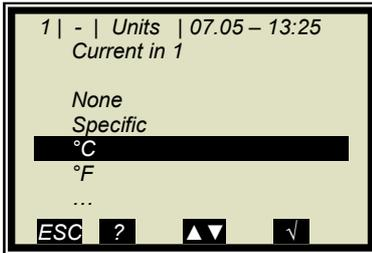

➤ °C

The temperature input can be set to °C, °F, none or specific.

5.1.6 Marker

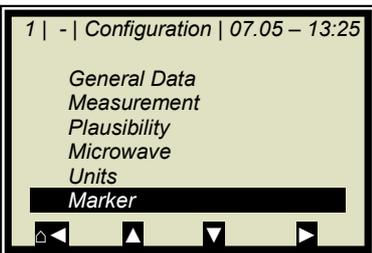

You can set a marker comprising max. 5 characters which identify the value set in the live display.

➤ MARKERS

5.2 Start Calibration Coefficients

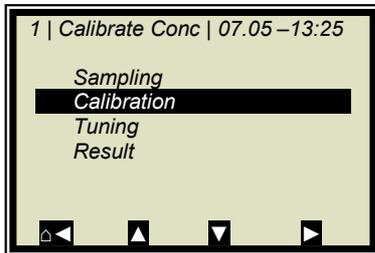

Starting from the main menu, go to the display shown on the left via:

ESC | SETUP | CALIBRATION | CALIBRATE CONC |

➤ CALIBRATION

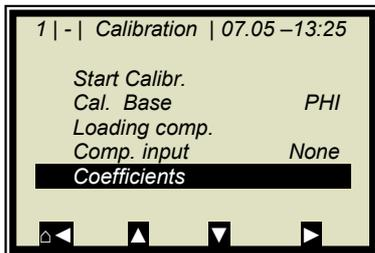

➤ COEFFICIENTS

For the default setting, the concentration is calculated as follows:

$$\text{Measured value} = A \cdot \text{Phase} + C \quad \text{Eq. 5-1}$$

where:

A, C: Calibration coefficients

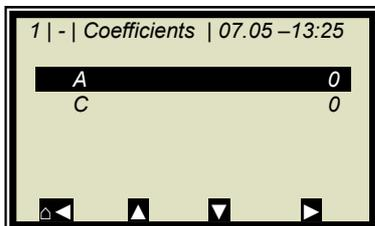

Check the coefficients A and C and correct them, if necessary, as follows:

C = average measuring range value (concentration value)

A = 0

All coefficients that are not needed are automatically set to zero.

Note: With these calibration coefficients the concentration average value and thus the current output is put on hold during start-up.

5.3 Configure Plausibility

Starting from the main menu, go to the display shown on the left via:

| SETUP | CONFIGURATION | PLAUSIBILITY | PHASE MEASURE
|

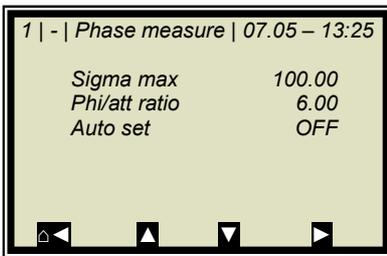

The display on the left shows the default settings, which may have to be entered.

During normal measurement operation, **Sigma** lies between 0 to 100. Therefore, $\text{Sigma}_{\text{max}} = 100$ is a good choice for most applications. However, if you constantly get sigma values up to 300 during the measurement, you may increase the limit up to 500. Higher sigma values than that usually indicate a fault, such as continuous air bubbles which have to be eliminated.

For most applications, the **Phi/att ratio** is not known; therefore, it has to be determined once. For this, you need the Auto setting, which otherwise must always be set to OFF.

The exact procedure is described in *chapter 9.1*.

Chapter 6. Calibration

Note: The measuring system must have reached normal operating temperature (approx. 45 min. warm-up time)).
 The flow cell must be completely filled with product or the container probe is completely surrounded by product.
 The measuring system has to operate at a normal throughput and/or material flow and the usual material under actual operating conditions.

Prerequisite: **Chapter 5. Configuration** have been completed.

6.1 System Adjust

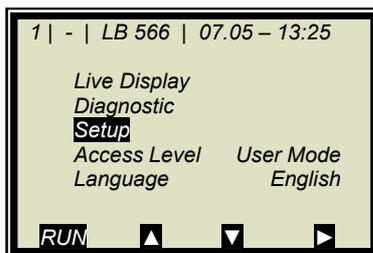

Starting from the main menu:

➤ SETUP

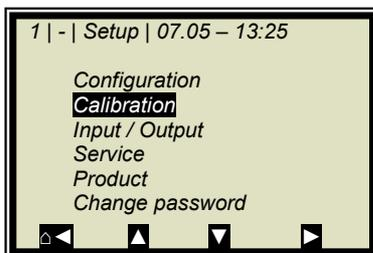

➤ CALIBRATION

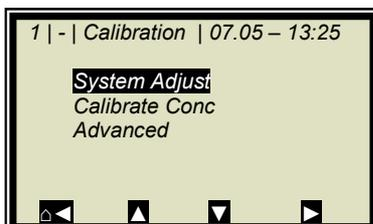

➤ SYSTEM ADJUST

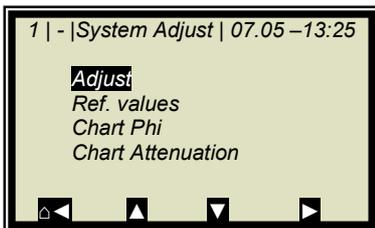

➤ ADJUST

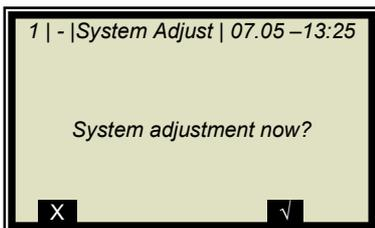

Confirm

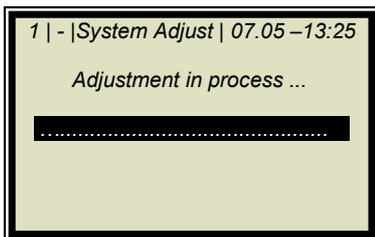

System adjustment is in process.

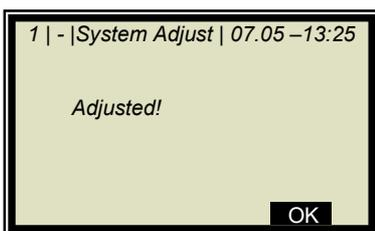

Push **OK** to confirm and push  three times to return to the main menu.

6.1.1 Verifying the Reference Values

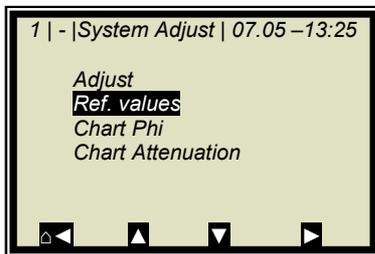

Starting from the main menu, go to the display shown on the left via | SETUP | CALIBRATION | SYSTEM ADJUST |

➤ REFERENCE VALUES

Limits of important parameters for the reference measurement:

- Sigma: <300 (reliable microwave irradiation)
- Attenuation: <45 dB with standard evaluation unit MicroPolar <65 dB with high dynamic evaluation unit MicroPolar ++ (Cables connected properly, product irradiatable)

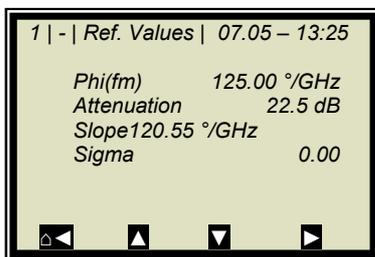

6.2 Sampling

For temperature compensation, the product temperature must be entered via one of the analog inputs and in addition the corresponding input has to be enabled. If not, the product temperature is not stored in the device during sampling.

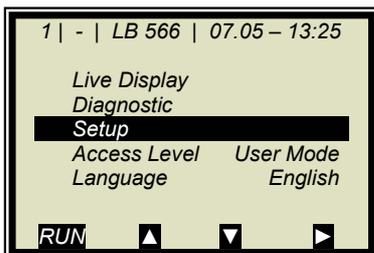

If the measuring system is not yet in the measurement mode, start the measurement now.

Push **RUN** to start the measuring system.

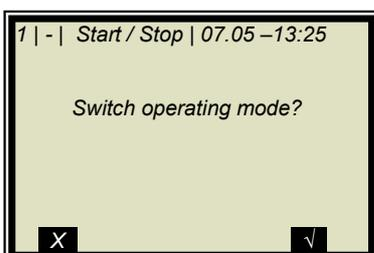

Push **✓** to confirm the safety prompt and the device switches to the measurement mode.

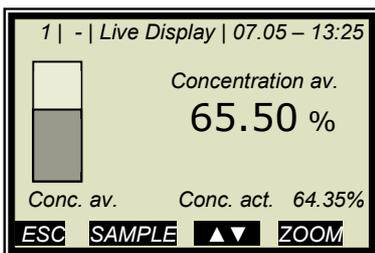

The display to the left appears if you push **RUN**.

Note: Push the **SAMPLE** button to start measurement of the raw data. At the same time, the laboratory sample has to be taken and marked. The analysis may be performed later, provided the product is not changed by this.

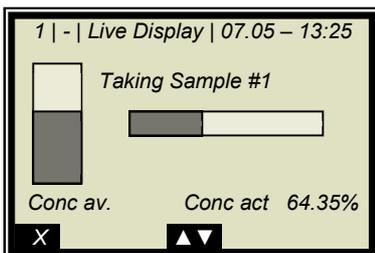

Sampling is in process.....

Push the **X** button to stop the sampling process any time..

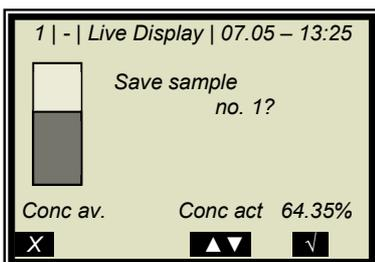

If the sampling process has been completed without any problem, push the **✓** button to save the sample in the table and the measurement continues.

The process previously described must be repeated for each additional sample.

The moisture/concentration of the samples should be distributed over the entire measuring range. For additional temperature compensation, the temperature of the samples should be distributed over the entire temperature range.

The minimum number of samples required is dependent on the selected calibration modes. If the sample size is too low, an error message is displayed after you have attempted to run a calibration.

About six samples suffice for a rough calculation of the calibration coefficients, provided the concentration differs by at least 5%. At least 15 samples are required for fine calibration and temperature compensation.

6.2.1 Entering the Lab Values

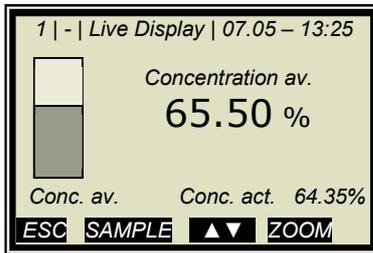

Push **ESC** to go to the main menu. A measurement can be stopped only in the main menu.

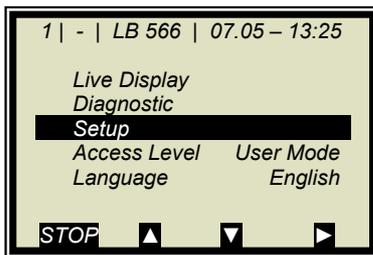

Push **STOP** to stop the measuring system.

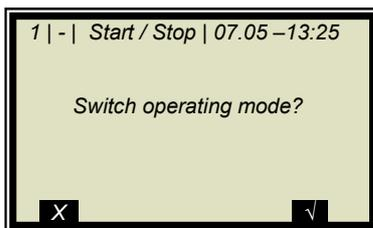

Push **✓** to confirm the prompt and the measurement switches to the **STOP** mode.

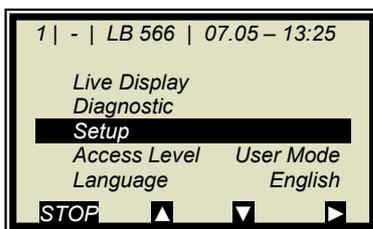

➤ SETUP

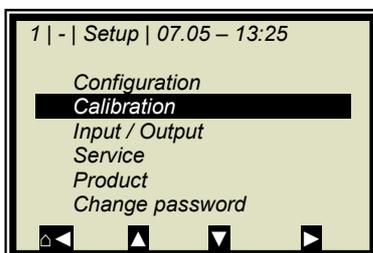

➤ CALIBRATION

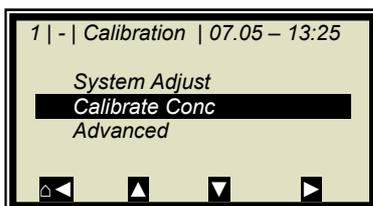

➤ CALIBRATE CONC

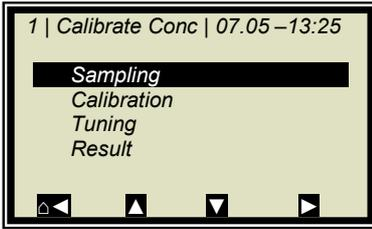

➤ SAMPLING

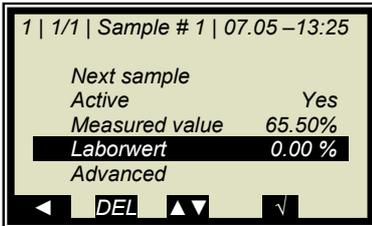

➤ LAB VALUE

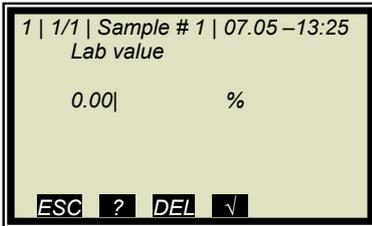

Delete default value with **DEL** and enter new value and confirm with **√**

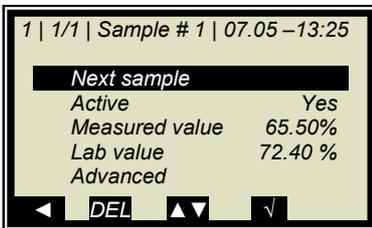

➤ NEXT SAMPLE

and repeat the step described above with the next sample.

After you have entered the last sample by pushing the der **◀** button you get back to the Calibration menu. (Short push – one page, longer push of the button – you get back to the Calibration menu immediately)

6.3 Calibration

Proceed as described in *chapter 8.4.*

Chapter 7. Start-up of MicroPolar ++

System adjustment and calibration are carried out in just the same way for MicroPolar ++, as they are for the standard system MicroPolar. However, please keep in mind that the ++ unit requires a minimum attenuation of 40 dB over the entire concentration range and during system adjustment. When falling below, the measurement is not precise anymore.

The total attenuation is calculated as follows:

$$dB_{total} = dB_{adjust} + dB_{live} + 0.4 \times \text{signal cable length} \quad \text{Eq. 7-1}$$

where:

dB_{total} :	Total attenuation
$dB_{adjustment}$:	Attenuation during system calibration
dB_{live} :	Current attenuation in the measurement mode
Signal cable length:	e.g. 4 m HF-cable quad results in 8 m signal cable length (to and from)

The evaluation unit monitors the entire attenuation automatically and reports a falling below by an error message (error no. 55).

Remedy when falling short of the attenuation:

If the required overall attenuation is not reached, you have the option to install a 10 dB fixed attenuator into the transmitting branch (see Fig. 7-1). The standard model MicroPolar should be used if the attenuation is clearly below the required value.

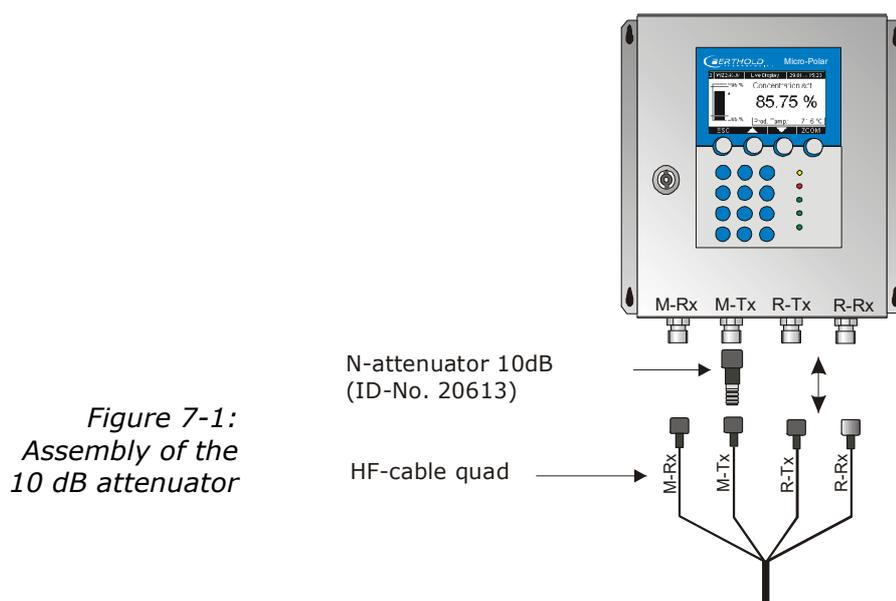
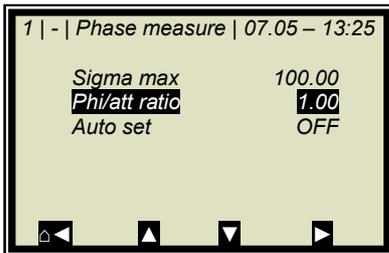

Figure 7-1:
Assembly of the
10 dB attenuator

Chapter 8. Calibration and Advanced

8.1 Plausibility | Configuring Phi/Att Ratio

Starting from the main menu, go to the display shown on the left via | SETUP | CONFIGURATION | PLAUSIBILITY | PHASE MEASURE |



Check or correct corresponding to the settings shown on the left.

➤ PHI/ATT RATIO

If you know the ratio value, enter it here; otherwise go to *chapter 8.1.1 Phi/att Ratio*.

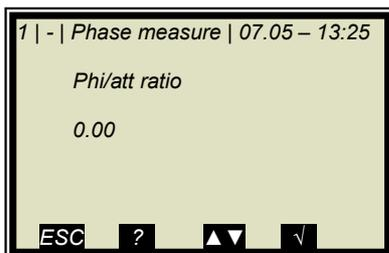

Delete default value with **DEL** and enter new value and confirm with **✓**

8.1.1 Phi/att Ratio

If you do not know the ratio value, proceed as follows:

1. Perform a process recording, see *chapter 8.1.2 Process Recording*. A prerequisite is that the process covers the entire concentration range during the recording.
2. If the process recording is currently not possible or if the concentration range is small anyway ($< \pm 5\%$), then enter **Phi/att = 1** as start value.

Subsequent adjustment of the process recording is possible.

8.1.2 Process Recording

Prerequisite:

The steps described in chapter

5. Configuration

6.1 System Calibration

have been completed.

The process recording is used to determine the ratio of phase and attenuation (Phi/att), a parameter of the plausibility analysis for correct determination of the phase.

If you already know the ratio from other measurements, you may enter it directly on the PLAUSIBILITY menu (see *chapter 4.2.10 Phase Measurement*); in this case, that process need not be recorded.



IMPORTANT

The measurement takes place automatically; you only have to start and stop it again. During measurement, please keep in mind:

- Do not stop the measurement
- Do not change the concentration erratically (max. 1 %).
- Cover the entire measuring range, if possible

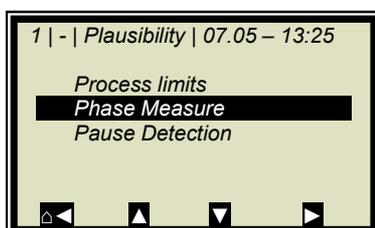

Starting from the main menu, go to the display shown on the left via:

| SETUP | CONFIGURATION | PLAUSIBILITY | PHASE MEASURE
|

➤ PHASE MEASUREMENT

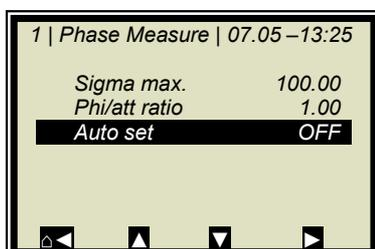

➤ AUTO SET

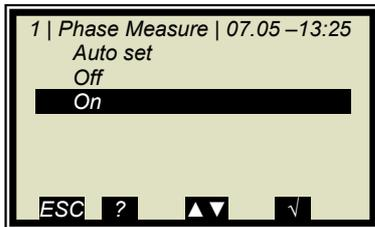

➤ ON

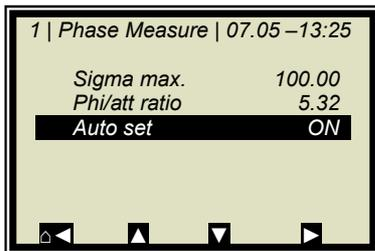

Pause recording:

You have the option to pause recording by turning the recording off. The recording is paused and starts again only after it is turned on again.

Start new recording:

Prerequisite: Recording is turned off. Stop and start the measurement before you start a new recording. The result of older recordings will be deleted.

Stop recording:

After recording, simply turn off the automatic recording; the recorded Phi/att is stored automatically.

Carry out sampling while the process recording is running.
Do not forget to enable the process recording again as described above!

8.2 Adjusting the Calibration

A correction factor and an offset may be entered later to obtain a subsequent adjustment of the calibration (fine tuning).

Below please find an example for an offset adjustment.

The display to the left appears if you push **RUN**.

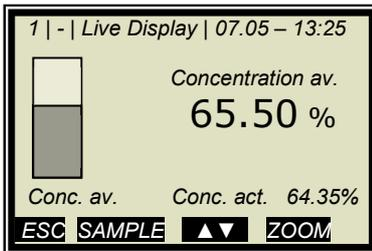

The display reading is now compared with the analysis value of the lab sample. The difference has to be entered as offset with the correct algebraic sign.

Calculation:

$$\text{Analysis value} - \text{Display} = \text{Offset}$$

Eq. 8-1

Push **ESC** to return to the main menu.

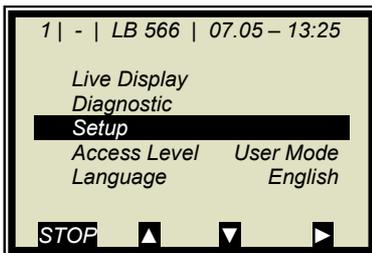

➤ SETUP

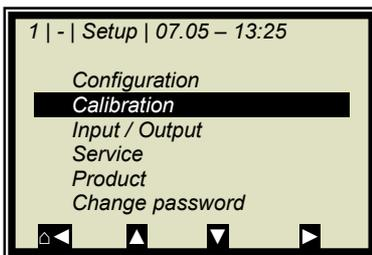

➤ CALIBRATION

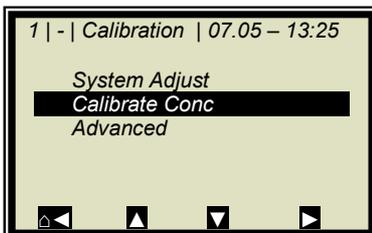

➤ CALIBRATE CONC

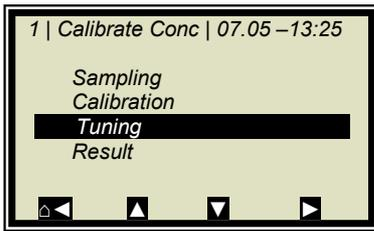

➤ TUNING

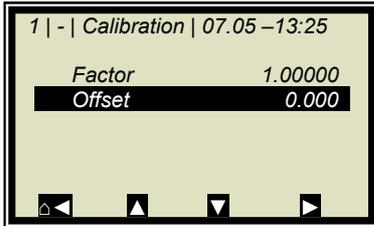

➤ OFFSET

Calculation formulas see *chapter 4.2.16 Calibrate Concentration*.

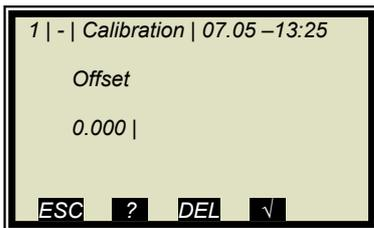

Enter the calculated offset value, confirm with button and push the Home button four times to return to the main menu.

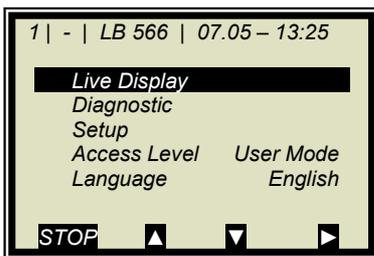

Select

➤ LIVE DISPLAY

to get back to the display.

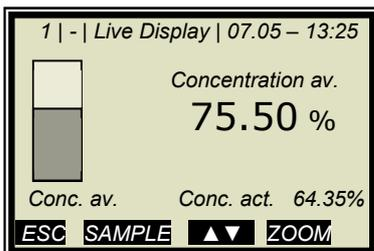

The reading value should now correspond to the actual value.

8.3 Output of the Start-up Protocol

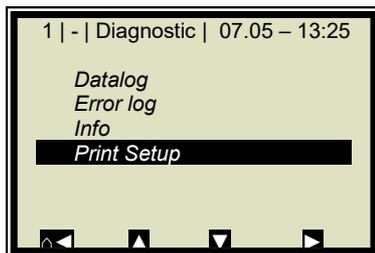

Starting from the main menu, go to the display on the left by selecting | DIAGNOSTIC |

➤ PRINT SETUP

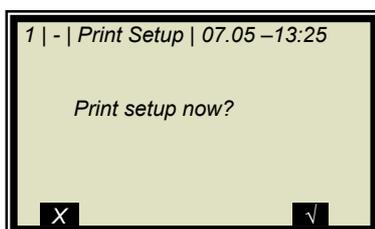

Push the button to print the setup via RS232 and RS485. Push to go back one page without printout.

The start-up protocol includes all parameters, system adjustment data, calibration data and entries in the sample table.

For further information on the start-up protocol see *chapter 11. Start-up Protocol*

8.4 Calibration

There are several setup options for calibration; for details see *chapter 4.2.20 Calibration*. Furthermore, the default settings are displayed, which, as a rule, are the best choice.

Prerequisite:

The steps described in chapter

5. Configuration

6.1 System Calibration

6.2 Sampling

have been completed.

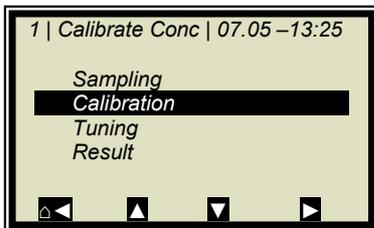

Starting from the main menu, go to the display shown on the left via:

| SETUP | CALIBRATION | CALIBRATE CONC |

➤ CALIBRATION

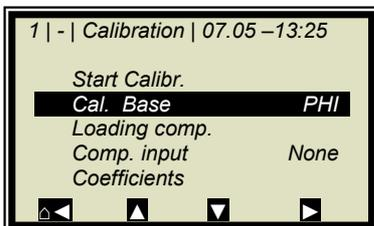

➤ CAL. BASE

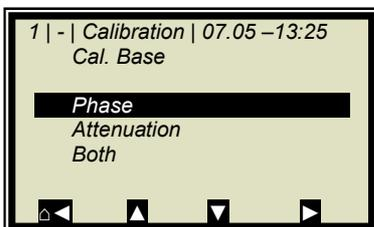

➤ PHASE (Phase measurement)

Standard for all applications: Phase

Set the desired compensation:

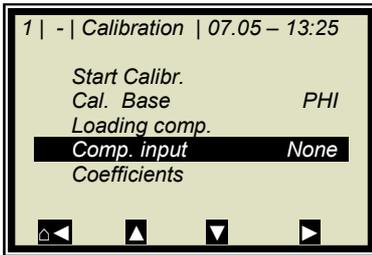

For compensation such as **temperature compensation** proceed as follows:

➤ COMPENSATION

Here you can select the analog inputs (PT100, current input 1 and 2) required for compensation (e.g. temperature compensation). You can select:

- None
- In1
- In1 + In2
- In1 + PT100
- In1 + In2 + PT100
- In2
- In2 + PT100
- PT100

Select "None" if no compensation is required.

The automatic calculation of the calibration coefficients starts as soon as you have set the parameters for the compensation.

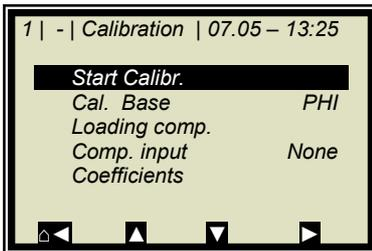

➤ START CALIBRATION

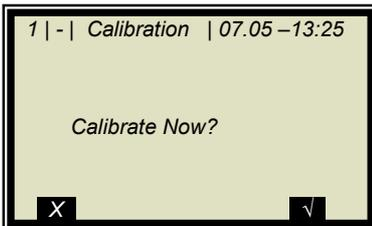

Push the **✓** button to start the calibration; push **X** to go back one page without calibration.

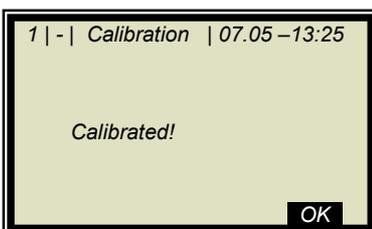

OK accepts the calibration and changes to the next display.

When calculating the new coefficient set, the Factor will be re-set to 1 and the Offset to 0.

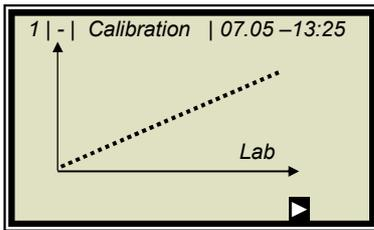

The graph on the left shows the measured value versus the lab value.

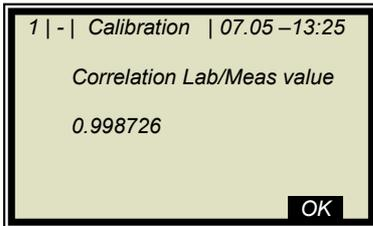

Output of the correlation between measured value and lab value.

OK

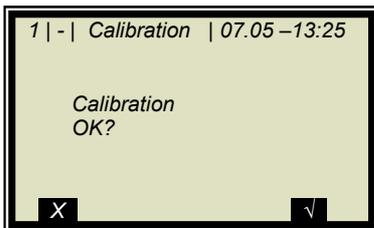

As soon as you confirm this prompt, the calibration display appears again; from there you get back to the main menu by pushing  four times.

8.4.1 Calibration with Two Concentrations

Calibration for two concentrations starts by changing the process type as described below.

Starting from the main menu, go to the display shown on the left via
| SETUP | CALIBRATION |

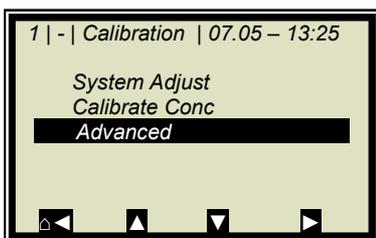

➤ ADVANCED

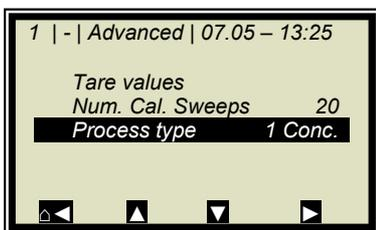

➤ PROCESS TYPE

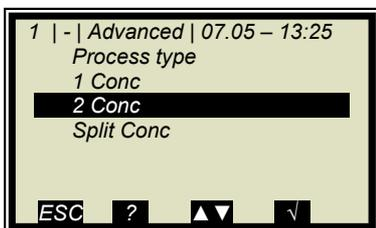

➤ 2 CONC

Push the button to accept the selected process type and push the once to go to the display depicted below.

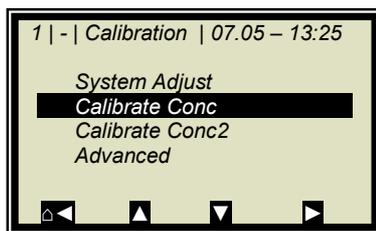

➤ CALIBRATE CONC (corresponding to concentration 1)

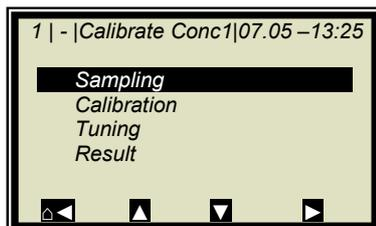

➤ SAMPLING

There is only one sample table for both calibrations.
The lab values have to be entered for all samples used for calibration of concentration 1. All other samples have to be disabled (Active: Yes/No).

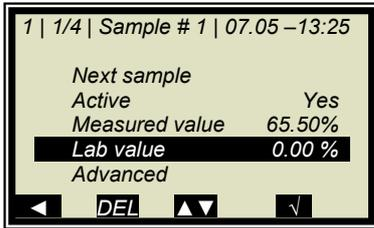

➤ LAB VALUE

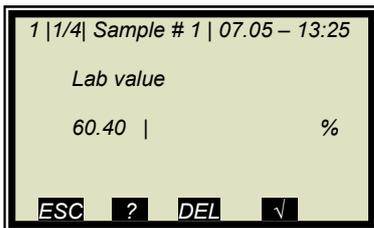

Delete default value with **DEL** and enter new value and confirm with **✓**

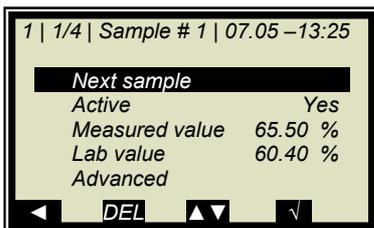

➤ NEXT SAMPLE

Continue with next sample

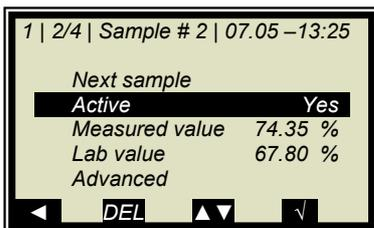

➤ ACTIVE

Disable sample

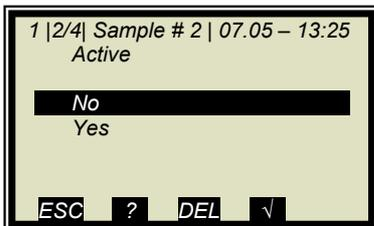

➤ NO

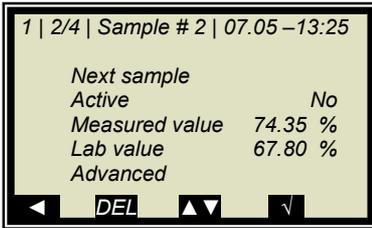

Make sure that all samples have been processed and only those samples are active which are relevant for this calibration.

Push **◀** to get to the Calibration page.

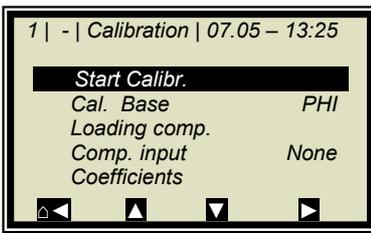
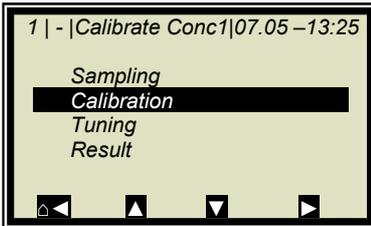

➤ START CALIBRATION

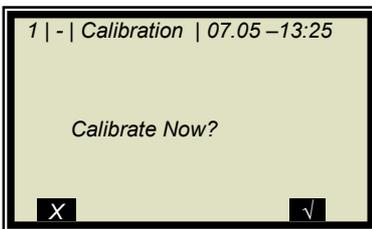

Push the **✓** button to start the calibration; push **X** to go back one page without calibration.

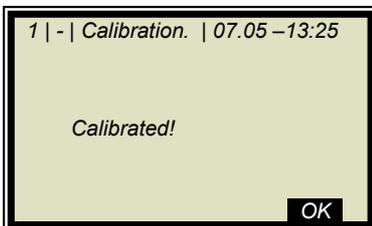

OK accepts the calibration and changes to the next display.

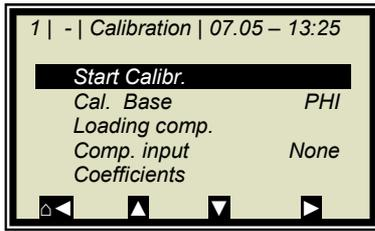

Push twice to return two pages.

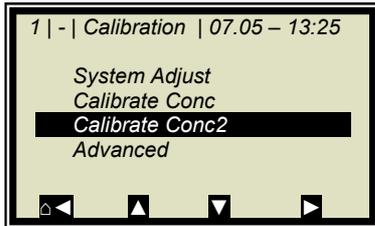

➤ CALIBRATE CONC 2

Repeat the steps as described above for concentration 2; all samples have to be enabled again in the sample table. Now you have to disable all samples which are not used for concentration 2.

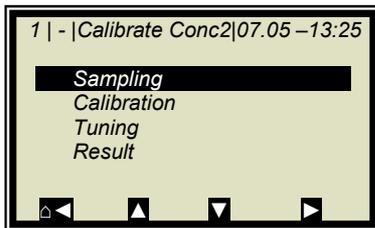

➤ SAMPLING

8.4.2 Calibration with Split Value

With this type of calibration, two characteristic curves (concentrations) are combined in one measuring range; their point of intersection defines the split value.

Conc 1 for the lower and conc 2 for the upper measuring range can be output only together via current output.

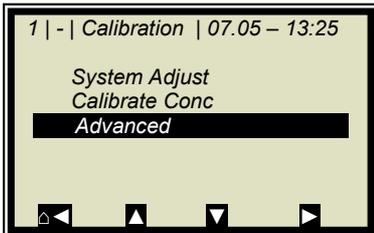

➤ ADVANCED

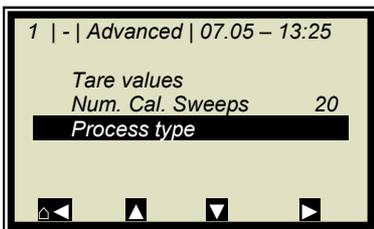

➤ PROCESS TYPE

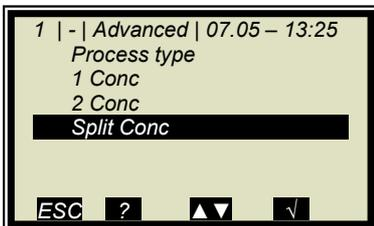

➤ SPLIT CONC

Push the button to accept the selected process type and push the button once to go to the display depicted below. The displayed split value has been set by the manufacturer, but has to be adapted to the respective application.

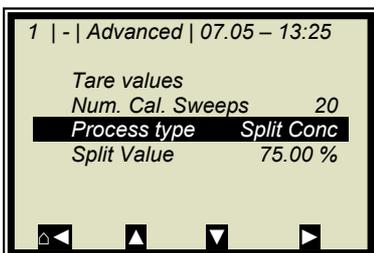

The sample measurement should be selected such that the last sample of the lower concentration is fairly close to the first sample measurement of the upper concentration. Ideally, the last sample of the initial concentration is the first sample of the final concentration.

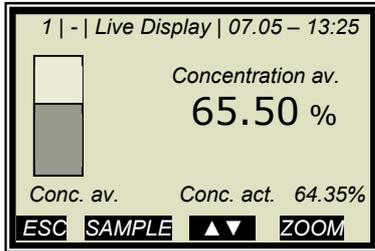

Sample measurements are carried out continuously over the entire measuring range with the display depicted to the left. See *chapter 6.3 Sampling*

After completion of sampling, the individual samples will be enabled or disabled during input of the laboratory values, relative to the set split values. All samples smaller or equal to the split value will be assigned to the lower concentration range and all samples above to the upper concentration range.

The assignment of the samples is carried out automatically, for example, by setting the split value or by entering the lab values have been entered (e.g. after re-sampling). The assignment depends on the split value and the lab value.

i IMPORTANT

The split value entry allows you to enable samples that have been disabled earlier through automatic assignment! In these cases, disabled samples should better be deleted or disabled again after a split value entry!

The split value to be set must correspond to the point of intersection of both calibration curves. This will be corrected automatically after the calibration (within certain limits).

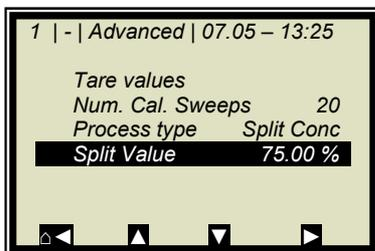

➤ SPLIT VALUE

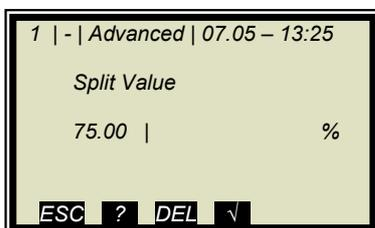

Enter the split value and confirm with .

Push to get to the Calibration page.

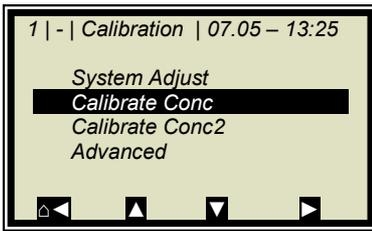

➤ CALIBRATE CONC

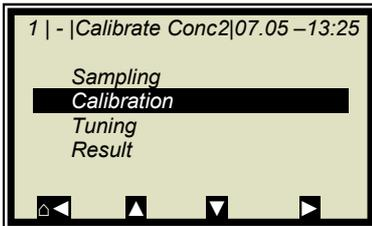

➤ CALIBRATION

The lower concentration is now calibrated. Then select CONC2 and repeat the calibration process. Go back to the main menu and start the measurement.

8.5 Typical Calibration Coefficients/Start Values

C: Concentration value at system calibration

For applications with container probe or flow cell nominal width DN 50 and without temperature compensation

A = - 0.19 to determine the concentration of dry matter

A = + 0.19 to determine the concentration of moisture

Chapter 9. Password

The measuring system can be protected against unauthorized access by passwords.

The access levels are as follows.

Read only

The measuring system cannot be started and stopped. You can only switch from the live display to Diagnostic and to Access Level.

User mode

The user mode is the default mode and provides access to all user-relevant parameters.

Service

The service level is reserved to service personnel.

You have to enter a password to change from **Read only** to **User Mode**.

At the time of delivery, this password is

PASS1

The password can be changed in the menu | SETUP | CHANGE PASSWORD |.

9.1 Password Forgotten

The device is in the "Read only" mode and the user has forgotten the password. Please proceed as follows to carry out a "Reset" of the user level:

Turn off device.

Turn on device; as soon as all 5 LEDs light up when powering up, press 0 (zero) and keep it depressed for 8 seconds.

Device powers up in the "User Mode". You can now enter a new password.



IMPORTANT

Check your process before turning off the device. The current outputs drop to 0 mA.

Chapter 10. Error Lists and Device States

The LEDs indicate the device status. Once the errors have been corrected, the measurement returns to the state before the error occurred. An acknowledgment is not required.

10.1 Power failures

Code	Error	Probable cause / correction
10	24V power fail	<i>Please contact the Berthold Technologies Service.</i>
11	9V power fail	<i>Please contact the Berthold Technologies Service.</i>
12	5V power fail	<i>Please contact the Berthold Technologies Service.</i>
13	3V power fail	<i>Please contact the Berthold Technologies Service.</i>
14	Battery fail	<i>Battery power is low, replace immediately, see Hardware Manual, chapter 5.4</i>

10.2 Temperature errors

Code	Error	Probable cause / correction
20	Attention: Ambient temperature too high!	<i>Check operating temperature of the evaluation unit, permissible range: -20 to 50° C or 45° C</i>
21	RF temperature out of range	<i>Check operating temperature of the evaluation unit, permissible range: -20 to 50° C or 45° C</i>

10.3 Hardware failures

Code	Error	Probable cause / correction
30	Program memory corrupted	<i>Please contact the Berthold Technologies Service.</i>
31	Data memory corrupted	<i>Please contact the Berthold Technologies Service.</i>
32	Parameter memory corrupted	<i>Compatibility check after software download: A general reset must be carried out.</i>
33	I2C-bus communication	<i>Please contact the Berthold Technologies Service.</i>
34	DAC update failure	<i>Please contact the Berthold Technologies Service.</i>
35	LCD contrast	<i>Please contact the Berthold Technologies Service.</i>
36	LCD controller	<i>Please contact the Berthold Technologies Service.</i>
37	Keypad error	<i>Please contact the Berthold Technologies Service.</i>
38	RF communication error	<i>Please contact the Berthold Technologies Service.</i>
39	RF hardware failure	<i>Faulty cable connection between the motherboard and HF unit. Check connector on the motherboard. Caution! First, disconnect the evaluation unit from the power supply!</i>
40	I/O communication error	<i>Please contact the Berthold Technologies Service.</i>
41	I/O module error	<i>Please contact the Berthold Technologies Service.</i>
42	RF Board startup error	<i>Please contact the Berthold Technologies Service.</i>

10.4 Sensor errors

Code	Error	Probable cause / correction
50	Phase variance too high	<i>The measured phase exceeds the allowed Sigma limit.</i>
53	No product	<i>The evaluation unit is in the Offline state (no product present).</i>
54	No system adjustment available	The system calibration has not yet been carried out.
55	Insertion loss under-run	See Software Manual, chapter 8

10.5 Analog input range errors

Code	Error	Probable cause / correction
60	Current input 1 out of range	The enabled current input has not yet been calibrated or is not occupied.
61	Current input 2 out of range	The enabled current input has not yet been calibrated or is not occupied.
62	Pt100 temperature out of range	The enabled PT100 input has not yet been calibrated or is not yet occupied.

10.6 Measurement range errors

Code	Error	Probable cause / correction
70	Concentration out of range	The concentration is outside the process limits.
71	Concentration 2 out of range	Concentration 2 is outside the process limits.
72	Loading value 1 below the limit	Below the minimum load for concentration 1
73	Loading value 2 below the limit	Below the minimum load for concentration 1
74	Loading comp. disabled. Cur. Input upper & lower value invalid	Current input is outside the range.
75	Sync. time too long	<i>Review settings for synchronization, see chapter 7.3 in Hardware Manual.</i>
76	Synchronization: speed out of range	<i>Review settings for synchronization, see chapter 7.3 in Hardware Manual.</i>
77	Waiting for sync. value	<i>The measurement has not yet been synchronized, please wait.</i>

10.7 Auxiliary measurement errors

Code	Error	Probable cause / correction
78	Mass flow 1 calc. disabled. Product speed invalid	<i>Please contact the Berthold Technologies Service.</i>
79	Mass flow 1 calc. disabled. Density invalid	<i>Please contact the Berthold Technologies Service.</i>
80	Mass flow 2 calc. disabled. Product speed invalid	<i>Please contact the Berthold Technologies Service.</i>
81	Mass flow 2 calc. disabled. Density invalid	<i>Please contact the Berthold Technologies Service.</i>

10.8 Analog output range errors

Code	Error	Probable cause / correction
90	Current output 1 out of range	The concentration calculated on the basis of the current is outside the current range
91	Current output 2 out of range	The concentration calculated on the basis of the current is outside the current range

10.9 Watchdog error

Code	Error	Probable cause / correction
92	Watchdog	Please contact the Berthold Technologies Service.

10.10 System errors

Code	Error	Probable cause / correction
120	No time / date setting	Please enter the date and the time.

10.11 Density errors

Code	Error	Probable cause / correction
150	Density calc.: Radiometric MPUA out of range	Check the measured value of the radiometric MPUA
151	Density calc.: Height signal out of range	Check the measured value of the layer thickness sensor

10.12 Input Error

Error	Probable Cause
<i>Value too large</i>	<i>Input value is too large</i>
<i>Value too small</i>	<i>Input value is too small</i>
<i>Table is empty</i>	<i>Sampling has been selected without previous sample measurement</i>
<i>Chart data faulty</i>	<i>The measuring system has determined faulty chart data during calibration.</i>
<i>No chart data available</i>	<i>The calculated chart data have been deleted or calibration has not been completed.</i>
<i>Sampling full</i>	<i>You have tried to measure more than 30 samples.</i>

10.13 Device States

Error state:

This state occurs also in error codes 50 to 56, 60 to 62 and 70 to 71 (see table above). The evaluation units behave as follows:

<u>LEDs:</u>	RUN flashes, ERROR on, signal 1 and 2 depending on the configuration.
<u>Current outputs:</u>	Fault current, as selected
<u>Display:</u>	Error message with error code

Warning state:

This state occurs also in error codes 14, 21, 90 and 91 (see table above). The evaluation units behave as follows:

<u>LEDs:</u>	RUN flashes, ERROR off, signal 1 and 2 no connection.
<u>Current outputs:</u>	live
<u>Display:</u>	Error message with error code

Hold state:

Measurement stopped via digital input. The evaluation units behave as follows:

The averaged concentration value is frozen. The measurement continues, however, so that a measurement error can cause the fault condition also from the hold state.

<u>LEDs:</u>	RUN flashes, ERROR off, signal 1 and 2 depending on the configuration.
<u>Current outputs:</u>	frozen
<u>Display:</u>	No display message

Offline state:

The evaluation unit is in the Offline state, no product is present. The evaluation units behave as follows:

<u>LEDs:</u>	RUN flashes, ERROR off, signal 1 and 2 depending on the configuration.
<u>Current outputs:</u>	lower current output value 0/4 mA
<u>Display:</u>	Error message with code no. 053 specification

Chapter 11. Start-up Protocol

The log can be output via RS232 and RS485. The printout takes place on the menu | DIAGNOSTIC | PRINT SETUP |.

The serial interfaces RS232 and RS485 have the following port settings:

Data transfer rate 38400 Bd, 8 data bits, no parity, 1 stop bit

The log is saved to a TXT file using a terminal program. To view the log (e.g. in Excel®), the following data format must be considered.

Separator: Tabulator

Decimal separator: .

Thousand separator: ,

The following code list helps you to interpret the start-up protocol, see example in *chapter 12.1*.

Parameter	Code no.	Information
<i>Log type</i>	0 1 2 3	<i>Log type:</i> Disabled Single Continuous Stop on error
<i>Log time</i>	0 1 2 3 4 5	<i>Log time:</i> 15 mins 1 hour 4 hours 8 hours 1 day 3 days
<i>Measuring mode</i>	0 1	<i>Meas. Mode:</i> Continuous Batch
<i>Start mode</i>	0 1	<i>Start mode (Start/Stop):</i> Keyboard Extern

Parameter	Code no.	Information
<i>Calibration input selection</i>	0 1 2 3 4 5 6 7	<i>Exp. cal. input selection:</i> None Input 1 Input 1 + Input 2 Input 1 + PT100 Input 1 + Input 2 + PT100 Input 2 Input 2 + PT100 PT100
<i>Calibration variable</i>	0 1 2	<i>Calibration base:</i> Phase Attenuation Phase and attenuation
<i>Massflow calculation mode</i>	0 1	<i>Throughput calculation:</i> Off On
<i>Measure configuration</i>	0 1 2	<i>Process type:</i> 1 concentration 2 concentrations Split concentration
<i>AO Assign Code</i>	0 1 2 3 4 5	<i>Assignment of current output:</i> None Concentration Concentration 2 Current input 1 Current input 2 PT100
<i>AO Alarm select code</i>	0 1 2 3	<i>Error current for current output:</i> 22 mA 3.5 mA Hold Value
<i>Range selection</i>	0 1	<i>Measuring range for current output:</i> 0 ... 20 mA 4 ... 20 mA
<i>AI Range selection</i>	0 1	<i>Measuring range for current input:</i> 0 ... 20 mA 4 ... 20 mA

Parameter	Code no.	Information
<i>AI Enabled[2]</i>		<i>State current in 2</i>
<i>DO Function</i>	0 1 2 3 4 5	<i>Function of digital outputs:</i> None Error Hold No product Alarm min. Alarm max.
<i>DO Assignment</i>	0 1 2 3 4	<i>Digital output: the min./max. alarm is assigned to the following:</i> Concentration Concentration 2 Current input 1 Current input 2 PT100
<i>DI Function selection</i>	0 1 2 3 4	<i>Function of digital inputs:</i> None Start/Stop Hold Sampling Product selection
<i>Printout mode</i>	0 1 2 3	<i>Form of data printout:</i> None Line Table Line + Table
<i>Access level</i>	0 1 2	<i>Access level:</i> Read only User mode Service
<i>Language</i>	0 1 2	<i>Language selection</i> English German French

11.1 Example of Start-up Protocol

Menu:	Start of Setup:	Start-up Protocol				Interpretation:
Product	Entry	Product1	Prod- uct2	Prod. 3	Prod. 4	(* Only relevant for service)
Data log	Log type :	0				Log type: see code list
	Log time:	2				Log time: see code list
	Number of errors :	0				Number of entries in the error log
	NTC temperature :	45.3 °C				*
	max. NTC temperature :	46.7 °C				*
	9V power supply :	8.94 V				*
Info	Tag :	-				Tag
	Device type :	LB 566				Device type
	Unique device ID number :	761				
	Serial number :	4294967000				
	Final assembly number :	000-000				
	Software version :	2.00				
	Software release date :	02.02.2016				Software revision date
	Actual date :	10.02.2016				Date of logging
	Actual time :	12:15				Time of logging
Measure- ment	Measuring mode :	0				Measuring mode: see code list
	Start mode :	0				Start mode: see code list
	Filter damping value[2] :	20				Averaging Current out- put
	Filter damping value[3] :	20				Averaging number when sampling
	Reset average :	FALSE				Reset Averaging: Yes/No
Plausibil- ity	Lower limit :	0.00				Min. process limit:
	Upper limit :	100.00				Max. process limit
	Raw data average value	5				*
	Max. phase sigma :	100				Sigma max.
	Correlation Phi/Att :	1:00				Ratio phase/attenuation
	Auto-set mode :	FALSE				Auto set: On/Off
	Offline Mode detection :	FALSE				Offline function: On/Off
	Minimum attenuation :	-15 dB				Limit for offline mode
Micro- wave	Ref. cable length :	8.00 m				Reference cable length
	Meas. cable length :	8.00 m				Signal cable length
	Wave band selection :	1				*
	Start frequency :	2				*
	Frequency step :	1				*
	Nbr of freq. points :	5				*
Marker	Marker name :	Mark1				Marker name for concentration
	Marker value :	75.00 %				Marker value for concentration
	Marker name[2] :	Mark2				Marker name for concentration 2
	Marker value[2] :	75.00 %				Marker value for concentration 2
System adjust	Nbr of sweeps for reference :	1				*
EVU type	HF amplifier mode :	0				*
	Minimal insertion loss :	40.00 dB				*

Calibrate Conc	Calibration input selection : 0	Exp. Cal. input selection: see code list
	Calibration mode 0	*
	Calibration variable : 0	Calibration basis: see code list
	Phase coefficients : 0	Phase coefficient A
	Attenuation coefficients : 0	Attenuation Coefficient B
	Constant coefficient : 0	Constant C
	d coefficient 0	Comp-coefficient for PT100 input
	e coefficient 0	Comp-coefficient for current input 1
	f coefficient 0	Comp-coefficient for current input 2
	g coefficient 0	Comp-coefficient for loading
	Adjust factor : 1	Factor
	Adjust offset : 0	Offset
	Massflow calculation mode: 0	Throughput calculation: see code list
	Loading comp. Selection: 0	*
	Loading comp. Lower limit: 0	*
Synchroni- zation	Synchronizer mode: 0	*
	Current input1 distance to uWave 0	*
	Current input1 distance to uWave 0	*
Calibrate Conc 2	Calibration input selection : 0	Exp. Cal. input selection: see code list
	Lower limit :	
	Upper limit :	
	Calibration mode : 0	*
	Calibration variable : 0	Calibration basis: see code list
	Phase coefficients : 0	Phase coefficient A
	Attenuation coefficients : 0	Attenuation Coefficient B
	Constant coefficient : 0	Constant C
	d coefficient 0	Comp-coefficient for PT100 input
	e coefficient 0	Comp-coefficient for current input 1
	f coefficient 0	Comp-coefficient for current input 2
	g coefficient 0	Comp-coefficient for loading
	Adjust factor : 1	Factor
	Adjust offset : 0	Offset
	Massflow calculation mode: 0	Throughput calculation: see code list
	Loading comp. Selection: 0	*
	Loading comp. Lower limit: 0	*
Advanced	Tare Phase (°/GHz) : 0.00 °/GHz	
	Tare Attenuation (dB) : 0.00 dB	
	Measure configuration : 0	Process type: see code list
	Range split value : 75	Split value
Current output 1	AO Assign code : 0	Assignment: see code list
	AO Upper range value : 95	Upper value
	AO Lower range value : 60	Lower limit
	AO Alarm select code : 2	Error current: see code list
	AO Error current value : 22.00 mA	Error current value
Current output 2	AO Assign code[2] : 0	Assignment: see code list
	AO Upper range value[2] : 95	Upper value
	AO Lower range value[2] : 60	Lower limit
	Range selection[2] : 1	Range
	AO Alarm select code[2] : 2	Error current: see code list
	AO Error current value[2] : 22.00 mA	Error current value

Current output 1	AI Enabled : 0 AI Range selection : 1 AI Upper range value : 100 AI Lower range value : 0 Analog input filter constant : 5	Disabled: 0 Range: see code list Upper value Lower limit * Enabled: 1
Current output 2	AI Enabled[2] : 0 AI Range selection[2] : 1 AI Upper range value[2] : 100 AI Lower range value[2] : 0 Analog input filter constant : 5	Disabled: 0 Range: see code list Upper value Lower limit * Enabled: 1
PT100 input	AI Enabled[3] : 0	Disabled: 0 Enabled: 1
Relay 1	DO Function : 1 DO Assignment : 0 DO Threshold : 0.00% DO Hysteresis : 5.00%	Function: see code list Assignment: see code list * *
Relay 2	DO Function[2] : 2 DO Assignment[2] : 0 DO Threshold[2] : 0.00% DO Hysteresis[2] : 5.00%	Function: see code list Assignment: see code list * *
Digital Input	DI Function selection : 0 DI Function selection[2] : 0 DI Function selection[3] : 0	Function digital input 1: see code list Function digital input 2: see code list Function digital input 3: see code list
	Printout mode : 1 Access level : 2 Language : 1	Data output: see code list Access level: see code list Language: see code list
	End of Setup	End

Start of Reference Data				System adjustment data:					
Product 1:									
Mean Atten.:		46.8509 dB							
Phase at fm:		42.6285 deg/GHz							
Phase slope:		380,984 deg/GHz							
Phase sigma:		0.24575							
Frequency[GHz]	Phase[Deg]	Transformed Phase[Deg]	Atten.[dB]						
	2.42	35.64	21.98						
	2.43	361.81	21.95						
	2.44	689.04	22.07						
	2.45	1014.44	22.36						
	2.46	1339.01	22.37						
Start of Sample Data:				Sampling:					
Product 1: Sample Data for Concentration 1:									
Sample:	Active:	Con.(%)	Lab.(%)	AIN1:	AIN2:	Temp. (°C):	Phi. (°/GHz):	Att.(dB):	
1 17.08 - 12:37	TRUE	85	40	0	0	0	-0.35	0.02	
2 17.08 - 12:37	TRUE	80	35	0	0	0	30.33	5.08	
3 17.08 - 12:45	TRUE	70	25	0	0	0	59.02	18.98	
Correlation factor between lab and meas values:		1							
End of Sample Data									
Do not use following data!									

11.2 Sampling

<i>No.</i>	<i>Ac- tive</i>	<i>Measured value</i>	<i>Lab value</i>	<i>Current in 1</i>	<i>Current In 2</i>	<i>PT100</i>	<i>Phi(fm):</i>	<i>Attenua- tion</i>	
1									
2									
3									
4									
5									
6									
7									
8									
9									
10									
11									
12									
13									
14									
15									
16									
17									
18									
19									
20									

