



Badger Meter

iSonic 4000

Open-Channel Flow Meter



CONTENTS

Scope of This Manual	5
Safety Precautions and Instructions	5
Installation	5
Power Connection	5
Protection Class	5
Setup and Operation	5
Cleaning	5
Repairing Faults	5
RoHs.	6
Battery Disposal	6
System Description	6
Nameplate	6
System Settings.	7
Installation.	8
Installation the EchoPod DL-10 Sensor	8
Mounting Positions	9
Power Connections	9
Auxiliary Power	10
Operation	12
Function Buttons.	12
Display Icons	12
Initial Screens	12
Setting a PIN.	13
Logging In	13
Logging Out.	13
Programming	14
Main Menu.	14
Meter Setup Menu.	15
Measurement Menu.	16
Input/Outputs Menu	20
Clear Total	23
Communications Menu.	24
Miscellaneous.	24
Info Menu	25

PIN Menu	25
Login Menu	25
Troubleshooting	26
Control LED	26
Replace Meter's Electronics	26
Specifications	27
Dimensions	28
Main Menu Program Structure	29
Meter Setup	29
Measurements	29
Inputs/Outputs	30
Total	30
Communications	30
Miscellaneous	30
Info	30
Pin	30
Login	30
Flow Meter ModBus® Register Table	31
iSonic 4000 Flow Meter Conversion Table	35
Rights	35
Wiring the iSonic 4000 Meter to an ORION® Cellular LTE Endpoint	36

SCOPE OF THIS MANUAL



This manual contains instructions for installing, operating and programming the iSonic 4000 flow meter.

IMPORTANT

Read this manual carefully before attempting any installation or operation. Keep the manual accessible for future reference.

SAFETY PRECAUTIONS AND INSTRUCTIONS

Some procedures in this manual require special safety considerations. In such cases, the text is emphasized with the following symbols:

Symbol	Explanation
 WARNING	Warning indicates the potential for severe personal injury, death or substantial property damage. Comply with the instructions and proceed with care.
 CAUTION	Caution indicates the potential for minor personal injury or property damage. Comply with the instructions and proceed with care.

Before installing or using this product, please read this instruction manual thoroughly. Only qualified personnel should install and/or repair this product. If a fault appears, contact your distributor.

Installation

- Do not place any unit on an unstable surface that may allow it to fall.
- Never place the units above a radiator or heating unit.
- Route all cabling away from potential hazards.
- Isolate from the mains before removing any covers.

Power Connection

- Use only the type of power source suitable for electronic equipment. If in doubt, contact your distributor. Ensure that any power cables are of a sufficiently high current rating.
- All units must be earthed to eliminate risk of electric shock. Failure to properly earth a unit may cause damage to that unit or data stored within it.

Protection Class

The device has protection class IP 67 and needs to be protected against dripping water, water, oils, etc.

Setup and Operation

Adjust only those controls that are covered by the operating instructions. Improper adjustment of other controls may result in damage, incorrect operation or loss of data.

Cleaning

Switch off all units and isolate from mains before cleaning. Clean using a damp cloth. Do not use liquid or aerosol cleaners.

Repairing Faults

Disconnect all units from power supply and have it repaired by a qualified service person if any of the following occurs:

- If any power cord or plug is damaged or frayed
- If a unit does not operate normally when operating instructions are followed
- If a unit exposed to rain/water or if any liquid has been spilled into it
- If a unit has been dropped or damaged
- If a unit shows a change in performance, indicating a need for service.

⚠ WARNING

FAILURE TO ADHERE TO THESE SAFETY INSTRUCTIONS MAY RESULT IN DAMAGE TO THE PRODUCT OR SERIOUS BODILY INJURY.

RoHs

Our products are RoHs compliant.

Battery Disposal

The batteries contained in our products need to be disposed of as per your local legislation, according to EU directive 2006/66/EG.

SYSTEM DESCRIPTION

The iSonic 4000 Ultrasonic flow meter is designated for flow measurements in open channels and partially filled pipes and volume measurements of liquids in tanks. You can connect one ultrasonic level sensor with 4...20 mA output to the unit. Flows are consequently calculated from measured levels using pre-programmed formulas for various primary flow elements (flumes, weirs) or from the Q/h table. The unit can also calculate flow rates in partially filled pipes and angular open channels using the Manning equation.

- The iSonic 4000 flow meter is an IP67 device in a robust wall-mounted metal case, with a large graphic display.
- The flow meter menu is operated with three front panel high endurance buttons.
- The flow meter is powered externally by 92...275V AC / 50...60 Hz. The DC version is powered externally by 9...36V DC (maximum 9 W).
- You can operate the flow meter via connection to a USB or Ethernet interface with Flow Meter Tool software, which can be used for parameter setup and datalogger download.
- The flow meter has an internal datalogger with 2 MB capacity for approximately 130,000 logged lines. You can download the logged data with the Flow Meter Tool software and save it in .csv format to a PC.
- USB, Ethernet, ADE, RS232, Modbus RS485/RS422 galvanic isolated interfaces are mounted on the board.
- The flow meter has one analog output (0...20 mA or 4...20 mA) and two galvanic isolated pulse outputs.

Nameplate

Look at the device nameplate to make sure the device is delivered according to your order. Check for the correct supply voltage printed on the nameplate.

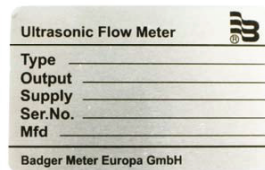

System Settings

Flow Meter Tool Settings

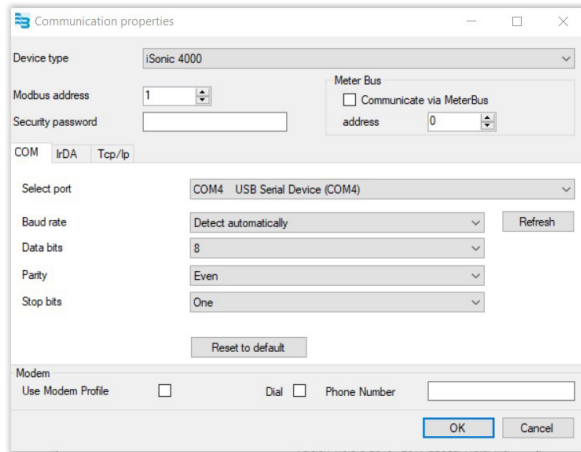

Settings Control Panel

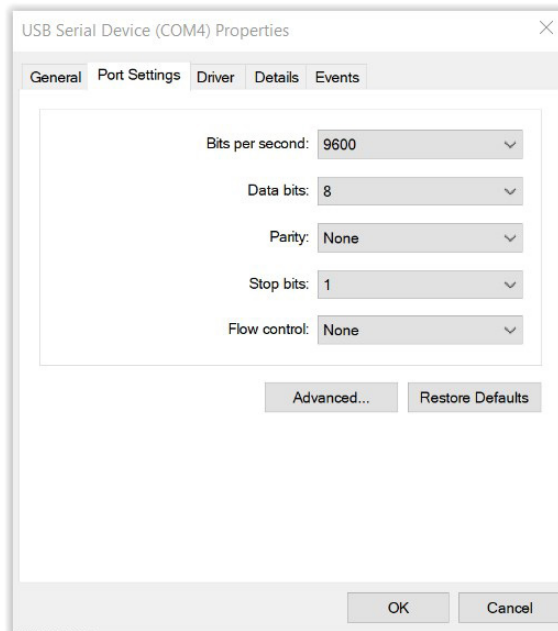

Driver Details

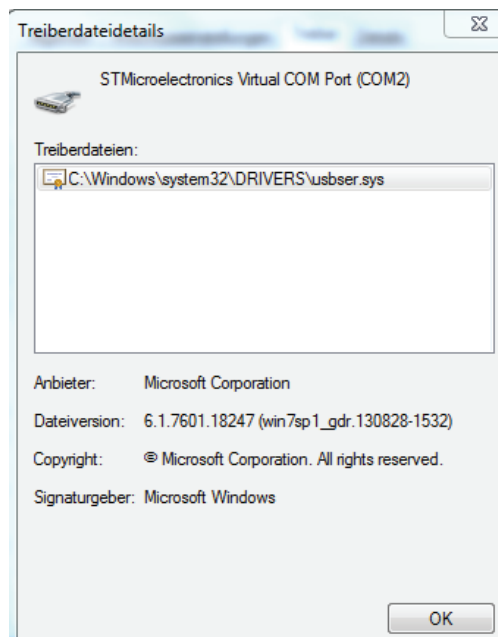
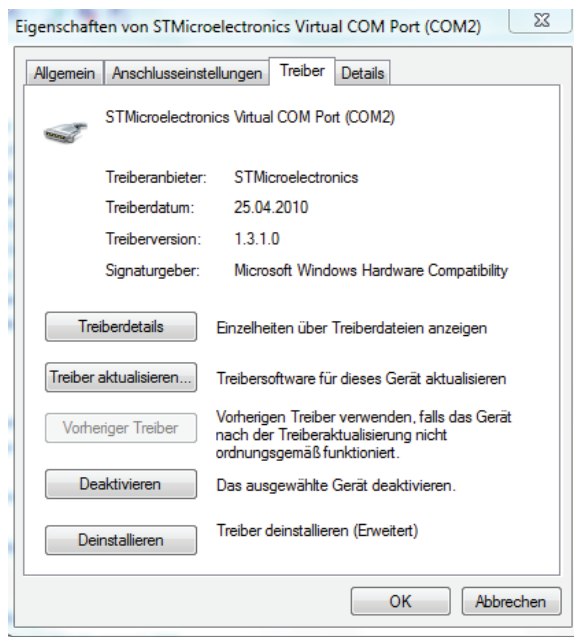

FCOMM-Protokoll-TDI

INSTALLATION

⚠ WARNING

INSTALLATION INSTRUCTIONS GIVEN IN THE FOLLOWING ARE TO BE OBSERVED IN ORDER TO PROVIDE FUNCTIONALITY AND SAFE OPERATION OF THE METER.

Installation the EchoPod DL-10 Sensor

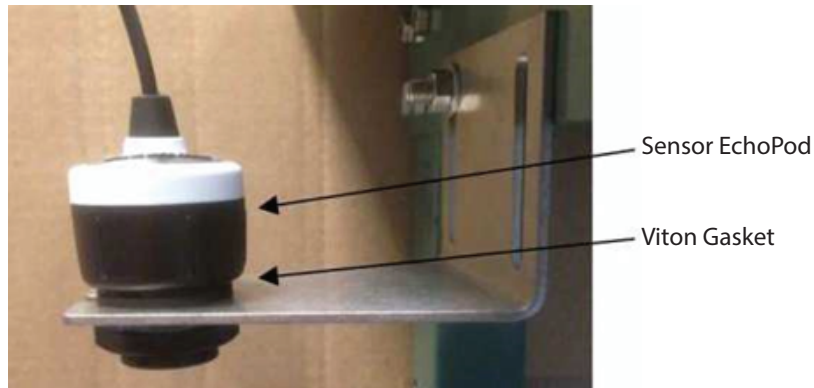

1. Insert the gasket onto the threaded end of the sensor.
2. Screw the sensor into the stainless steel mounting bracket.

NOTE: Install the sensor at a maximum of 49.21 in. (125 cm) above the flume bottom (minimal measured level) with a minimum of 1.97 in. (5 cm) distance above the maximal measured level.

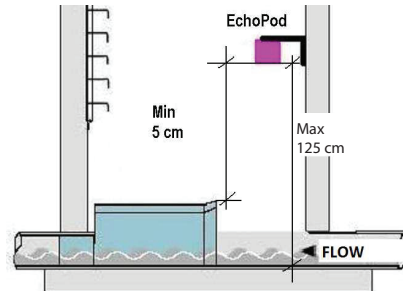

3. Connect the sensor to the 4...20 mA input terminal on the bottom side of display board.

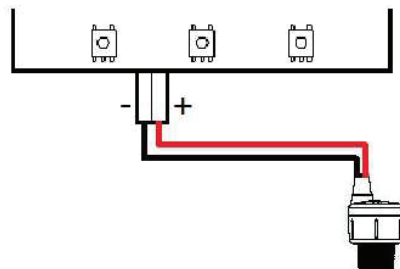

Mounting Positions

Manhole Flume

Size	Max. Flow	Max. Water Level	V-Mt	H-Mt
in. (DN)	g/sec (l/sec)	in. (mm)	in. (mm)	in. (mm)
4 (100)	1.32 (5)	5.83 (148)	23.62 (600)	5.75 (146)
6 (150)	4.23 (16)	8.94 (227)	23.62 (600)	7.75 (197)
8 (200)	9.25 (35)	12.28 (312)	23.62 (600)	9.76 (248)
10 (250)	16.64 (63)	15.55 (395)	27.56 (700)	11.73 (298)
12 (300)	24.83 (94)	18.00 (457)	27.56 (700)	13.74 (349)

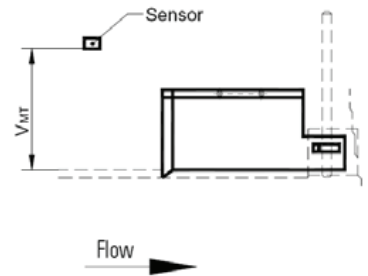

Parshall Flume

Size	Max. Flow	V-Mt	H-Mt
in. (DN)	g/sec (l/sec)	in. (mm)	in. (mm)
3 (75)	14.26 (54)	30.71 (780)	12.00 (305)
6 (150)	30.12 (114)	30.71 (780)	15.98 (406)
9 (230)	77.67 (284)	38.19 (970)	22.52 (572)
12 (305)	157.98 (598)	contact factory	contact factory
18 (455)	24.83 (94)	contact factory	contact factory

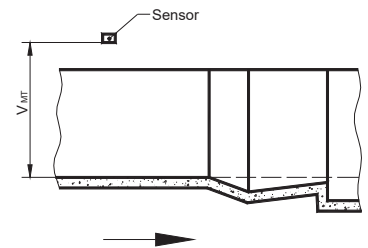

POWER CONNECTIONS

CAUTION

FOR THE 2 × M20 CABLE INLETS, USE ONLY FLEXIBLE ELECTRIC CABLES. USE SEPARATE CABLE INLETS FOR AUXILIARY POWER, SIGNAL AND INPUT/OUTPUT CABLES.

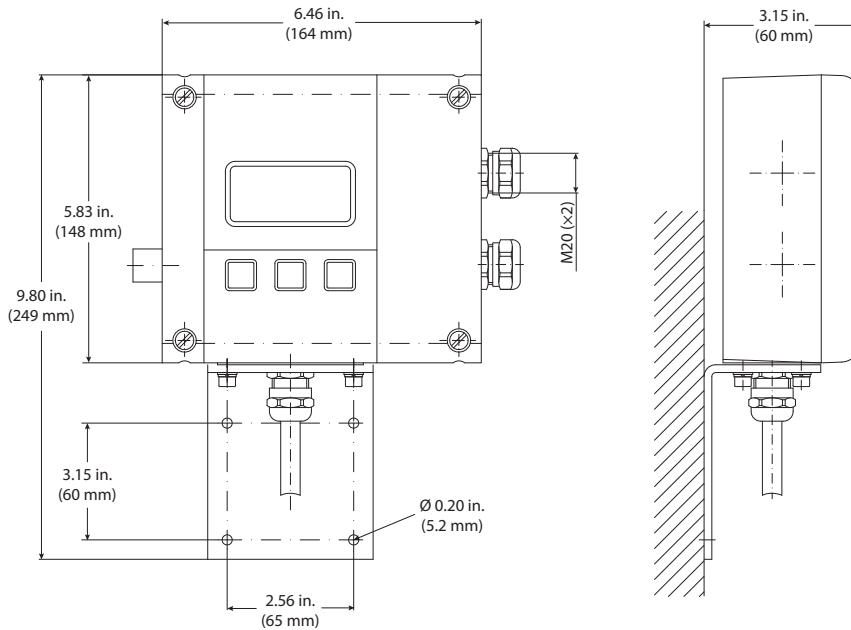

Auxiliary Power

⚠ WARNING

- **DO NOT CONNECT METER TO POWER SOURCE UNDER CONDITIONS THAT COULD CAUSE PERSONAL INJURY OR DAMAGE TO THE EQUIPMENT.**
 - **WIRING OF THIS EQUIPMENT MUST COMPLY WITH LOCAL AND NATIONAL CODES AND BE WITHIN THE VOLTAGE AND FREQUENCY RATING LISTED ON THE METER.**
 - **INSTALL EQUIPMENT WITH AN EXTERNAL MEANS FOR DISCONNECTING IT FROM POWER, SUCH AS A SWITCH OR A CIRCUIT BREAKER.**
1. Slightly loosen the lower cover screws.
 2. Completely loosen both upper cover screws.
 3. Open the cover to the lower side.
 4. Push the auxiliary power cable through the upper cable inlet.
 5. Connect the power as shown in *Figure 1* or *Figure 2*, depending on the version (AC or DC) of meter you have.
 6. Close the cover and tighten the four screws.

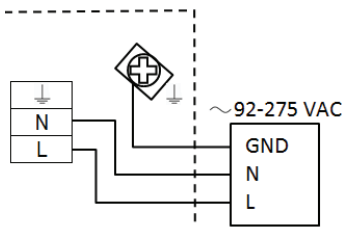

Figure 1: Power supply 92...275V AC (50/60 Hz); recommended cable size min. 0.3 sq. in. (0.75 mm²)

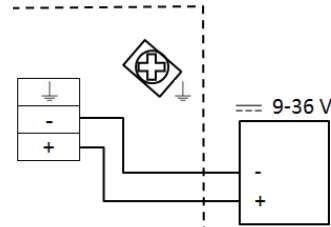
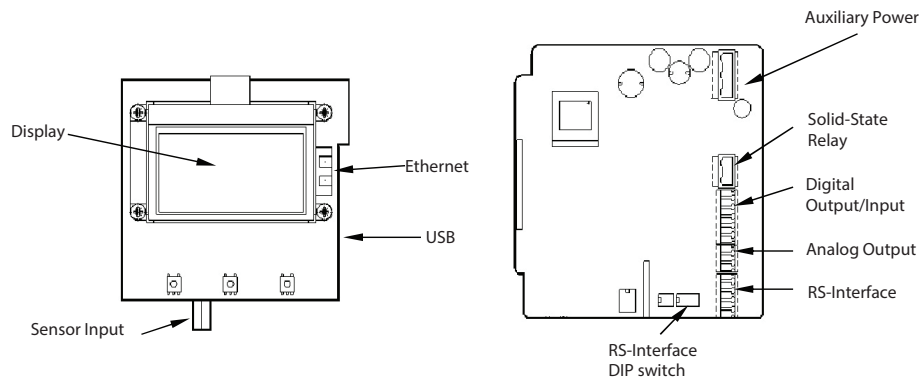

Figure 2: Power supply 9...36V DC (max. 9 W); recommended cable size min. 0.3 sq. in. (0.75 mm²)

Configuring Input/Outputs (I/O)



Input/Output	Description	Terminal																		
Analog output*	0...20 mA, 4...0 mA, $R_L < 800 \text{ Ohm}$, 0...10 mA	7 (+), 8 (-), 9 (GND)																		
Digital output	1* Open collector max. 10 kHz, Passive max. 32V DC, <100 Hz 100 mA, >100 Hz 20 mA, Active 24V DC, 20 mA, (can be powered by analog output if not used)	3 (-), 4 (+)																		
	2* Open collector max. 10 kHz, Passive max. 32V DC, <100 Hz 100 mA, >100 Hz 20 mA, Active 24V DC, 20 mA, (can be powered by analog output if not used)	1 (-) 2 (+)																		
	3 Solid-state relays max. 230V AC, 500 mA, max. 1 Hz (function is linked to Output 2)	S1 and S2																		
Digital input*	5...30V DC	5 (-) and 6 (+)																		
RS interfaces*	RS232, RS485 and RS422 with Modbus RTU. Mode can be configured by DIP switches also termination ON or OFF. For the RS485, connect the A wire to the Y terminal and the B wire to the Z terminal.	<table border="1"> <tr> <td>422</td> <td>232</td> <td>485</td> </tr> <tr> <td>A</td> <td>RxD</td> <td></td> </tr> <tr> <td>B</td> <td></td> <td></td> </tr> <tr> <td>Z</td> <td>TxD</td> <td>B</td> </tr> <tr> <td>Y</td> <td></td> <td>A</td> </tr> <tr> <td colspan="3" style="text-align: center;">G (GND)</td> </tr> </table>	422	232	485	A	RxD		B			Z	TxD	B	Y		A	G (GND)		
422	232	485																		
A	RxD																			
B																				
Z	TxD	B																		
Y		A																		
G (GND)																				
USB	USB Device CDC (Host Mass Storage)	Micro USB																		
Ethernet*	Ethernet Interface connection	RJ45 socket																		

* All marked inputs and outputs are according to safety data TNV-1 IEC 60950-1.

Input and Output Cable Connections

For the normal I/Os, use shielded cables. Connect the shield of the cable to one of the grounding screws. Recommended cable is LiYCY size min. 0.06 sq. in. (0.14 mm²).

Solid-State Output

If using a second cable gland for the normal I/Os, use one cable and cable gland for the power supply and solid-state relay. Recommended cable size is min. 0.3 sq. in. (0.75 mm²).

CAUTION

- **USE SEPARATE CABLE INLETS FOR CABLES CONNECTED TO THE SOLID-STATE RELAY OUTPUT AND CABLES CONNECTED TO THE OTHER INPUT/OUTPUTS.**
- **WITH MULTIPHASE POWER, SOLID-STATE RELAY SHOULD HANDLE ONLY THE SAME PHASE THAT IS USED FOR POWERING THE METER.**

OPERATION

Function Buttons

All programming is accomplished using the three function buttons on the front of the unit. Screen navigation and digit and parameter selection is performed by a combination of these buttons.



Use the **up-arrow** to scroll through the menu screens or to advance numerical digits to change values.

Use the **right-arrow** to select digits from left to right and allows or to enter a submenu.

Use **EXIT SAVE** to save changed values, return to a previous menu or toggle between *Measuring* mode and *Programming* mode.

Display Icons

	Minor battery power (Realtime clock)	W	Sensor warming
	Device error	O	Sensor not connected
	No keyword active	M	Sensor measuring
	USB active	S	Simulation active

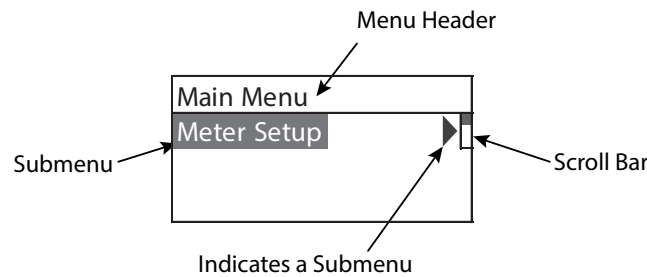

Initial Screens

From the *Main Menu*, press **EXIT SAVE** to display the current values and system information. The first screen to display depends on the application type (open channel or tank).

First screen for open channel applications:	First screen for tank applications:	Second screen for both applications.																																					
<table border="1"> <thead> <tr> <th>Parameter</th> <th>Value</th> <th>Unit of Measure</th> </tr> </thead> <tbody> <tr> <td>Volume</td> <td>305.6</td> <td>m³</td> </tr> <tr> <td>Level</td> <td>0.50</td> <td>m</td> </tr> <tr> <td>Flow</td> <td>8.85</td> <td>m³/s</td> </tr> <tr> <td colspan="2"></td> <td>M ← Icons</td> </tr> </tbody> </table>	Parameter	Value	Unit of Measure	Volume	305.6	m ³	Level	0.50	m	Flow	8.85	m ³ /s			M ← Icons	<table border="1"> <thead> <tr> <th>Parameter</th> <th>Value</th> <th>Unit of Measure</th> </tr> </thead> <tbody> <tr> <td>Volume</td> <td>50.3</td> <td>m³</td> </tr> <tr> <td>Level</td> <td>0.503</td> <td>m</td> </tr> <tr> <td colspan="2"></td> <td>1 ← Icons</td> </tr> </tbody> </table>	Parameter	Value	Unit of Measure	Volume	50.3	m ³	Level	0.503	m			1 ← Icons	<table border="1"> <thead> <tr> <th></th> <th>Tag</th> </tr> </thead> <tbody> <tr> <td>Application</td> <td>Tag: iSonic 4000</td> </tr> <tr> <td>Version</td> <td>1.2.00</td> </tr> <tr> <td>Date & Time</td> <td>2017-07-30 10:05</td> </tr> <tr> <td>Parameter, Value & Unit</td> <td>Current 10.184 mA</td> </tr> </tbody> </table>		Tag	Application	Tag: iSonic 4000	Version	1.2.00	Date & Time	2017-07-30 10:05	Parameter, Value & Unit	Current 10.184 mA
Parameter	Value	Unit of Measure																																					
Volume	305.6	m ³																																					
Level	0.50	m																																					
Flow	8.85	m ³ /s																																					
		M ← Icons																																					
Parameter	Value	Unit of Measure																																					
Volume	50.3	m ³																																					
Level	0.503	m																																					
		1 ← Icons																																					
	Tag																																						
Application	Tag: iSonic 4000																																						
Version	1.2.00																																						
Date & Time	2017-07-30 10:05																																						
Parameter, Value & Unit	Current 10.184 mA																																						

Setting a PIN

The iSonic 4000 flow meter security feature allows the option to restrict access to the meter by way of a 6-digit Personal Identification Number (PIN). The system administrator can set up a single PIN for each of the three different levels of access:

- **Administration** – allows access to all iSonic 4000 flow meter menu configuration screens.
- **Service** – allows access to service-level and user-level menu configuration screens.
- **User** – allows access only to user-level menu configuration screens.

NOTE: For a lost PIN, Contact Badger Meter Technical Support at 800-456-5023 for a replacement PIN.

Not all levels of access need to be set. If no PINs are set up, any user will have access to all functions.

1. From the *Main Menu*, press the **right-arrow**.
2. From the *Meter Setup* menu, press the **up-arrow** until the *Pin* menu is displayed.
3. Press the **right-arrow** to display the *PINS Control* menu.
4. Press the **right-arrow** to highlight ON or OFF.
5. With either ON or OFF highlighted, press the **up-arrow** to display ON.
6. Press **EXIT SAVE** to save the ON setting.
7. With the *Control* menu highlighted, press the **up-arrow** to display the required security level (user, service, or admin).
8. With the required security level highlighted, press **EXIT SAVE** to display the first of six zeros (digits).
9. Press the **up-arrow** to change the first digit, followed by pressing the **right-arrow** to select the next digit.
10. Press the **EXIT SAVE** button to save the PIN number for that security level.

Logging In

To change any parameter, the PIN entered must provide the proper security privilege required by the parameter.

To enter a PIN, go to the *Login* menu and enter the PIN for the required security level.

Once you are properly logged in, the unlocked icon appears on the meter display.

NOTE: A **PIN Error** message displays if the incorrect PIN is entered.

Logging Out

To log out, follow steps 1 through 8 under "*Setting a PIN*". At step 9, enter an invalid PIN, then press **EXIT SAVE**.

PROGRAMMING

Main Menu

From the *Main Menu*, you can access these submenus, each of which is described on the following pages:

- Meter Setup
- Measurements
- Input and Outputs
- Totalizer Reset
- Communication
- Miscellaneous
- Information
- Pin

The security levels are:

 Administrative







 Service

 User



 Parameters indicated by the battery icon, if changed, will affect battery performance.

To program the security levels, see "*Setting a PIN*" on *page 13*. No passwords were set at the factory.

Meter Setup Menu

Application	Tank 	Select for a tank application.
	Open Channel 	Select for an open channel application.
Sensor	Interval 	Setup of time measurement interval(s); default value is 1 second; larger interval (for instance, 300 seconds) is set when unit is powered from battery
	WarmUpTime 	Powering time of sensor(s) before measurement; larger interval is set when unit is powered from battery
	LowerRangeValue 	The minimum level value of used sensor = 4 mA in selected level units
	UpperRangeValue 	The maximum level value of used sensor = 20 mA in selected level units
	Offset 	Level offset in selected level units, depends of sensor mounting position

Measurement Menu

<p>Length</p> 	<p>Establishes the unit of measure for the length</p> <table border="1" data-bbox="347 296 708 506"> <thead> <tr> <th><i>Display</i></th> <th><i>Length Unit</i></th> </tr> </thead> <tbody> <tr> <td>ft</td> <td>Feet</td> </tr> <tr> <td>m</td> <td>Meter</td> </tr> <tr> <td>in.</td> <td>Inch</td> </tr> <tr> <td>cm</td> <td>Centimeter</td> </tr> <tr> <td>mm</td> <td>Millimeter</td> </tr> </tbody> </table> <p>DecimalPlaces – set of the decimal places of the Length values</p>				<i>Display</i>	<i>Length Unit</i>	ft	Feet	m	Meter	in.	Inch	cm	Centimeter	mm	Millimeter																												
<i>Display</i>	<i>Length Unit</i>																																											
ft	Feet																																											
m	Meter																																											
in.	Inch																																											
cm	Centimeter																																											
mm	Millimeter																																											
<p>Flow Rate</p> 	<p>Establishes the unit of measure for the flow rate</p> <table border="1" data-bbox="347 596 1216 905"> <thead> <tr> <th><i>Display</i></th> <th><i>Flow Unit</i></th> <th><i>Display</i></th> <th><i>Flow Unit</i></th> </tr> </thead> <tbody> <tr> <td>L/s</td> <td>Liters/Second</td> <td>gal/s</td> <td>Gallons/Sec.</td> </tr> <tr> <td>L/min</td> <td>Liters/Minute</td> <td>gal/min</td> <td>Gallons/Min.</td> </tr> <tr> <td>L/h</td> <td>Liters/Hour</td> <td>gal/h</td> <td>Gallons/Hour</td> </tr> <tr> <td>m³/s</td> <td>Cubic Meters/Sec.</td> <td>MG/d</td> <td>MillionGallons/Day</td> </tr> <tr> <td>m³/min</td> <td>Cubic Meters/Min.</td> <td>IG/s</td> <td>ImperialGallons/Sec.</td> </tr> <tr> <td>m³/h</td> <td>Cubic Meters/Hour</td> <td>IG/min</td> <td>ImperialGallons/Min.</td> </tr> <tr> <td>ft³/s</td> <td>Cubic Feet/Sec.</td> <td>IG/h</td> <td>ImperialGallons/Hour</td> </tr> <tr> <td>ft³/min</td> <td>Cubic Feet/Min.</td> <td>Bbl/min</td> <td>Barrel/Min</td> </tr> <tr> <td>ft³/h</td> <td>Cubic Feet/Hour.</td> <td></td> <td></td> </tr> </tbody> </table> <p>DecimalPlaces – set of the decimal places of the Flow Rate values</p>				<i>Display</i>	<i>Flow Unit</i>	<i>Display</i>	<i>Flow Unit</i>	L/s	Liters/Second	gal/s	Gallons/Sec.	L/min	Liters/Minute	gal/min	Gallons/Min.	L/h	Liters/Hour	gal/h	Gallons/Hour	m ³ /s	Cubic Meters/Sec.	MG/d	MillionGallons/Day	m ³ /min	Cubic Meters/Min.	IG/s	ImperialGallons/Sec.	m ³ /h	Cubic Meters/Hour	IG/min	ImperialGallons/Min.	ft ³ /s	Cubic Feet/Sec.	IG/h	ImperialGallons/Hour	ft ³ /min	Cubic Feet/Min.	Bbl/min	Barrel/Min	ft ³ /h	Cubic Feet/Hour.		
<i>Display</i>	<i>Flow Unit</i>	<i>Display</i>	<i>Flow Unit</i>																																									
L/s	Liters/Second	gal/s	Gallons/Sec.																																									
L/min	Liters/Minute	gal/min	Gallons/Min.																																									
L/h	Liters/Hour	gal/h	Gallons/Hour																																									
m ³ /s	Cubic Meters/Sec.	MG/d	MillionGallons/Day																																									
m ³ /min	Cubic Meters/Min.	IG/s	ImperialGallons/Sec.																																									
m ³ /h	Cubic Meters/Hour	IG/min	ImperialGallons/Min.																																									
ft ³ /s	Cubic Feet/Sec.	IG/h	ImperialGallons/Hour																																									
ft ³ /min	Cubic Feet/Min.	Bbl/min	Barrel/Min																																									
ft ³ /h	Cubic Feet/Hour.																																											
<p>Volume</p> 	<table border="1" data-bbox="347 966 1216 1155"> <thead> <tr> <th><i>Display</i></th> <th><i>Volume Unit</i></th> <th><i>Display</i></th> <th><i>Volume Unit</i></th> </tr> </thead> <tbody> <tr> <td>L</td> <td>Liters</td> <td>MG</td> <td>MegaGallons</td> </tr> <tr> <td>hL</td> <td>HectoLiter</td> <td>IG</td> <td>Imperial Gallons</td> </tr> <tr> <td>m³</td> <td>Cubic Meters</td> <td>bbl</td> <td>Barrel</td> </tr> <tr> <td>Ft³</td> <td>Cubic Feet</td> <td>Aft</td> <td>Acre Feet</td> </tr> <tr> <td>gal</td> <td>US Gallons</td> <td></td> <td></td> </tr> </tbody> </table> <p>DecimalPlaces – set of the decimal places of the Volume values</p>				<i>Display</i>	<i>Volume Unit</i>	<i>Display</i>	<i>Volume Unit</i>	L	Liters	MG	MegaGallons	hL	HectoLiter	IG	Imperial Gallons	m ³	Cubic Meters	bbl	Barrel	Ft ³	Cubic Feet	Aft	Acre Feet	gal	US Gallons																		
<i>Display</i>	<i>Volume Unit</i>	<i>Display</i>	<i>Volume Unit</i>																																									
L	Liters	MG	MegaGallons																																									
hL	HectoLiter	IG	Imperial Gallons																																									
m ³	Cubic Meters	bbl	Barrel																																									
Ft ³	Cubic Feet	Aft	Acre Feet																																									
gal	US Gallons																																											

Equation Selection	Q/h Table selection is possible only from the Flow Meter Tool software																			
	Display	Description																		
	Exponential Eq	Exponential Function $Q = K h^{\text{exp}}$																		
	Contract.Weir	Contracted Weir																		
	Suppress.Weir	Suppressed Weir																		
	CipolettiWeir	Cipoletti Weir																		
	VNotchWeir30°	V Notch Weir 30°																		
	VNotchWeir45°	V Notch Weir 45°																		
	VNotchWeir60°	V Notch Weir 60°																		
	VNotchWeir90°	V NotchWeir 90°																		
	ManningRect.	Manning Rectangle Flume																		
	ManningPipe	Manning Pipe																		
	Pars.Flume1"	Parschall Flume 1"																		
	Pars.Flume2"	Parschall Flume 2"																		
	Pars.Flume3"	Parschall Flume 3"																		
	Pars.Flume6"	Parschall Flume 6"																		
	Pars.Flume9"	Parschall Flume 9"																		
	Par.Flume12"	Parschall Flume 12"																		
	Par.Flume18"	Parschall Flume 18"																		
	Par.Flume24"	Parschall Flume 24"																		
	Par.Flume36"	Parschall Flume 36"																		
	Par.Flume48"	Parschall Flume 48"																		
	Par.Flume60"	Parschall Flume 60"																		
Manh.Flume4"	Manhole Flume 4"																			
Manh.Flume6"	Manhole Flume 6"																			
Manh.Flume8"	Manhole Flume 8"																			
Manh.Flume10"	Manhole Flume 10"																			
Manh.Flume12"	Manhole Flume 12"																			
Equation Params	<table border="1"> <tbody> <tr> <td data-bbox="396 1100 993 1134">Exponent value in for equation ($Q = K h^{\text{exp}}$)</td> <td data-bbox="993 1100 1312 1134">Exponent</td> </tr> <tr> <td data-bbox="396 1134 993 1167">Coefficient value in for equation ($Q = K h^{\text{exp}}$)</td> <td data-bbox="993 1134 1312 1167">Coefficient</td> </tr> <tr> <td data-bbox="396 1167 993 1201">Measured profile width (Weirs, Manning equation)</td> <td data-bbox="993 1167 1312 1201">Width</td> </tr> <tr> <td data-bbox="396 1201 993 1234">Rectangular profile slopes angle (Manning equation)</td> <td data-bbox="993 1201 1312 1234">Angle</td> </tr> <tr> <td data-bbox="396 1234 993 1268">Measured pipe Radius (Manning equation)</td> <td data-bbox="993 1234 1312 1268">Radius</td> </tr> <tr> <td data-bbox="396 1268 993 1302">Water Surface Slope (Manning equation)</td> <td data-bbox="993 1268 1312 1302">WaterSurfaceSlope</td> </tr> <tr> <td data-bbox="396 1302 993 1335">Surface Roughness coefficient (Manning equation)</td> <td data-bbox="993 1302 1312 1335">SurfaceRoughness</td> </tr> <tr> <td data-bbox="396 1335 993 1369">Maximum Water Level</td> <td data-bbox="993 1335 1312 1369">MaximumWaterLevel</td> </tr> <tr> <td data-bbox="396 1369 993 1386">Flow Rate Upper Range Value</td> <td data-bbox="993 1369 1312 1386">UpperRangeValue</td> </tr> </tbody> </table> <p data-bbox="396 1394 812 1419">Maximum Water Level /SetDefaultVal.</p> <p data-bbox="396 1423 1393 1486">Set of the Maximum Water Level for the selected primary element – the value is possible to edit further.</p> <p data-bbox="396 1495 727 1520">Upper Range Value /Calculate</p> <p data-bbox="396 1524 1448 1587">Is calculating the maximal Flow Rate value for Maximal Water Level - the value is possible to edit further – this parameter is used also for outputs (Upper Range Value=100% - full range)</p>		Exponent value in for equation ($Q = K h^{\text{exp}}$)	Exponent	Coefficient value in for equation ($Q = K h^{\text{exp}}$)	Coefficient	Measured profile width (Weirs, Manning equation)	Width	Rectangular profile slopes angle (Manning equation)	Angle	Measured pipe Radius (Manning equation)	Radius	Water Surface Slope (Manning equation)	WaterSurfaceSlope	Surface Roughness coefficient (Manning equation)	SurfaceRoughness	Maximum Water Level	MaximumWaterLevel	Flow Rate Upper Range Value	UpperRangeValue
Exponent value in for equation ($Q = K h^{\text{exp}}$)	Exponent																			
Coefficient value in for equation ($Q = K h^{\text{exp}}$)	Coefficient																			
Measured profile width (Weirs, Manning equation)	Width																			
Rectangular profile slopes angle (Manning equation)	Angle																			
Measured pipe Radius (Manning equation)	Radius																			
Water Surface Slope (Manning equation)	WaterSurfaceSlope																			
Surface Roughness coefficient (Manning equation)	SurfaceRoughness																			
Maximum Water Level	MaximumWaterLevel																			
Flow Rate Upper Range Value	UpperRangeValue																			

Open Channel Calculation

Volumetric flow is calculated from actual water level. Actual water level is limited by the maximum water level.

The Exponential Equation for general Parshall or Manhole flume: $Q=K \cdot Q^{exp}$

Q – Volumetric flow [m³/s]

K – Coefficient [m⁽³⁻ⁿ⁾/s]

h – Water level [m]

exp – Exponent [-]

Predefined Flume	Equation [m ³ /s, m]	Max. Water Level [m]
Parshall flume 1 in.	$Q = 0.0604 \cdot h^{1.55}$	0.230
Parshall flume 2 in.	$Q = 0.1207 \cdot h^{1.55}$	0.260
Parshall flume 3 in.	$Q = 0.1771 \cdot h^{1.55}$	0.667
Parshall flume 6 in.	$Q = 0.3810 \cdot h^{1.55}$	0.724
Parshall flume 9 in.	$Q = 0.5350 \cdot h^{1.55}$	0.876
Parshall flume 12 in.	$Q = 0.7050 \cdot h^{1.55}$	0.925
Parshall flume 18 in.	$Q = 1.0670 \cdot h^{1.55}$	0.925
Parshall flume 24 in.	$Q = 1.4290 \cdot h^{1.55}$	0.925
Parshall flume 36 in.	$Q = 2.1900 \cdot h^{1.57}$	0.925
Parshall flume 48 in.	$Q = 2.9600 \cdot h^{1.58}$	0.925
Parshall flume 60 in.	$Q = 3.7500 \cdot h^{1.59}$	0.925
Manhole flume 4 in.	$Q = 0.2343 \cdot h^{1.95}$	0.149
Manhole flume 6 in.	$Q = 0.3026 \cdot h^{1.95}$	0.227
Manhole flume 8 in.	$Q = 0.3424 \cdot h^{1.95}$	0.313
Manhole flume 10 in.	$Q = 0.3868 \cdot h^{1.95}$	0.396
Manhole flume 12 in.	$Q = 0.4345 \cdot h^{1.95}$	0.457

Contracted rectangular weir

Equation $Q = 1.84 \cdot (L - 0.2 \cdot h) \cdot h^{1.5}$

Q – Volumetric flow [m³/s]

1.84 – Coefficient [$\sqrt{m/s}$]

L – Width [m]

h – Water level [m]

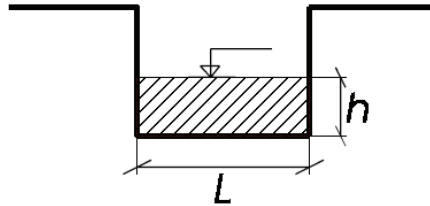

Suppressed rectangular weir

Equation $Q = 1.84 \cdot L \cdot h^{1.5}$

Q – Volumetric flow [m³/s]

1.84 – Coefficient [$\sqrt{m/s}$]

L – Width [m]

h – Water level [m]

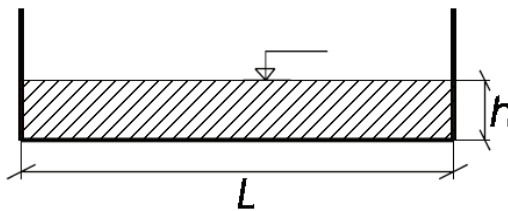

Cipoletti rectangular weir

Equation $Q = 1.84 \cdot L \cdot h^{1.5}$

Q – Volumetric flow [m³/s]

1.84 – Coefficient [$\sqrt{m/s}$]

L – Width [m]

h – Water level [m]

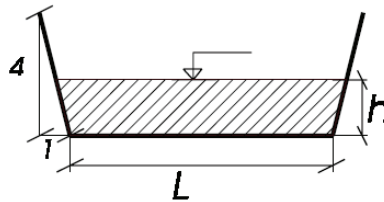

V-notch weir 30°

Equation $Q = \frac{8}{12} \sqrt{2 \cdot g} \cdot \tan\left(\frac{30^\circ}{2}\right) \cdot 0.586 \cdot (h + 0.0021)^{2.5}$

Q – Volumetric flow [m³/s]

g – Standard gravity 9.80665 [m/s²]

h – Water level [m]

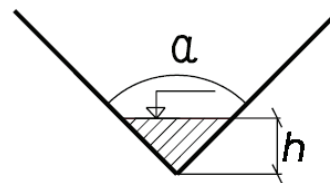

V-notch weir 45°

$$\text{Equation } Q = \frac{8}{12} \sqrt{2 \cdot g} \cdot \tan\left(\frac{45^2}{2}\right) \cdot 0.580 \cdot (h + 0.0015)^{2.5}$$

Q – Volumetric flow [m³/s]
 g – Standard gavity 9.80665 [m/s²]
 h – Water level [m]

V-notch weir 60°

$$\text{Equation } Q = \frac{8}{12} \sqrt{2 \cdot g} \cdot \tan\left(\frac{60^2}{2}\right) \cdot 0.577 \cdot (h + 0.0012)^{2.5}$$

Q – Volumetric flow [m³/s]
 g – Standard gavity 9.80665 [m/s²]
 h – Water level [m]

V-notch weir 90°

$$\text{Equation } Q = \frac{8}{12} \sqrt{2 \cdot g} \cdot \tan\left(\frac{90^2}{2}\right) \cdot 0.578 \cdot (h + 0.0008)^{2.5}$$

Q – Volumetric flow [m³/s]
 g – Standard gavity 9.80665 [m/s²]
 h – Water level [m]

Manning equation: $Q = 1/n R_h^{2/3} I^{1/2} A$ $R_h = A/P$

Manning rectangular

$$\text{Equation } Q = \frac{1}{n} \left(\frac{h \cdot L + \frac{h^2}{\sin \alpha}}{\frac{h \cdot L + \frac{h^2}{\sin \alpha}}{2 \cdot h} + L} \right)^{2/3} \cdot \sqrt{I} \cdot h \cdot L + \left(\frac{h^2}{\sin \alpha} \right)$$

Q – Volumetric flow [m³/s]
 n – Gauckler-Manning coefficient [s³√m]
 L – Width [m]
 h – Water level [m]
 α – Angle [°]
 I – Water surface slope [m/m]

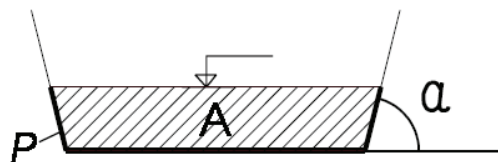

Manning pipe

$$\text{Equation } Q = \frac{1}{n} \left(\frac{(a - \sin \alpha) \cdot r}{2 \alpha} \right)^{2/3} \cdot \sqrt{I} \cdot \left(\frac{(a - \sin \alpha) \cdot r^2}{2} \right) \text{ where}$$



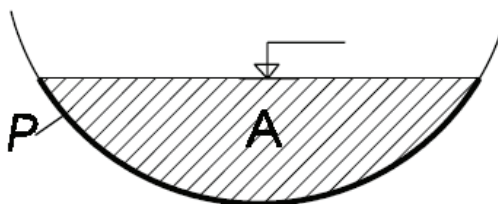

$$\alpha = \begin{cases} 2 \cdot \pi - 2 \cdot \arcsin\left(\frac{\sqrt{2 \cdot h \cdot r - h^2}}{r}\right) & | h > r \\ 2 \cdot \arcsin\left(\frac{\sqrt{2 \cdot h \cdot r - h^2}}{r}\right) & | h \leq r \end{cases}$$



Q – Volumetric flow [m³/s]
 n – Gauckler-Manning coefficient [s³√m]
 L – Width [m]
 h – Water level [m]
 I – Water surface slope [m/m]

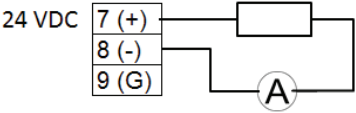
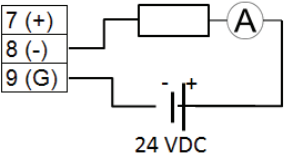



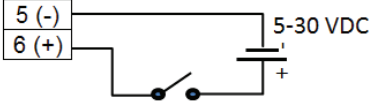
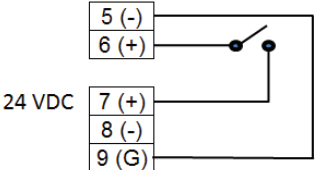

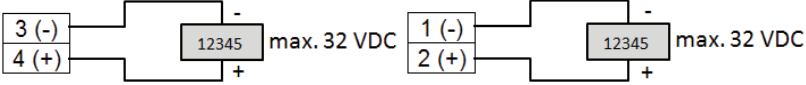
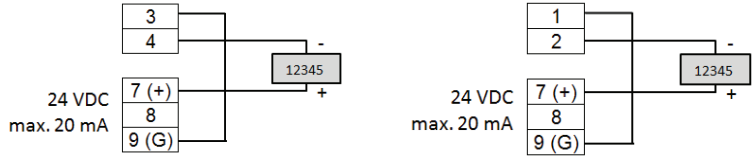

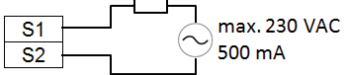
Material	n = s ³ √m	Material	n = s ³ √m	Material	n = s ³ √m
Glass , PVC	0.010	Gravel, firm	0.023	Natural channels, poor	0.060
Cement, concrete, steel	0.011	Earth channel, gravelly	0.025	Floodplains, heavy brush	0.075
Brick	0.015	Earth channel, weedy	0.030	Floodplains, trees	0.150
Earth, smooth	0.018	Natural streams, clean	0.035		
Earth channel, clean	0.022	Floodplains, light brush	0.050		

Input/Outputs Menu

<p>Analog Output</p>	<p>Range</p> 	<p>Establishes the range of the analog output signal: 0...100% (= full scale). The following current output ranges are available:</p> <ul style="list-style-type: none"> • 0...20 mA • 4...20 mA • 0...10 mA <p>Analog output active</p>  <p>Analog output passive</p>  <p>NOTE: If an error message displays, set the current according the programming of the <i>Alarm Mode</i> below. When you select bidirectional operation, you can signal the flow direction via digital outputs.</p>
	<p>Alarm Mode</p> 	<p>This parameter configures the behavior of the analog output during alarm conditions. The options are <i>OFF</i>, <i>3.5 mA</i> and <i>23 mA</i>.</p> <ul style="list-style-type: none"> • <i>OFF</i>: Analog signal is based on flow rate and always within the configured range. • <i>3.5 mA</i>: During alarm conditions, the analog signal is 3.5. • <i>23 mA</i>: During alarm conditions, the analog signal is 23 mA. <p>For example, if the analog range is 4...20 mA and the alarm mode is set to 23 mA, then during a full scale flow alarm condition, the analog output current will be 23 mA.</p>
	<p>Compensation</p> 	<p>Correction of the current value output.</p>
<p>Digital Input</p> 		<p>Digital input lets you reset totalizers (remote reset), interrupt flow measurement (PosZeroReturn) or ADE. Input switching is provided by applying an external potential of 5...30V DC</p>  <p>or by an internal voltage source of 24V DC (analog output if not used).</p> 

<p>Digital Outputs</p>	<p>You can configure functional operation of the 2 digital outputs. For example, you can select <i>Forward Pulse</i> for the digital output and define the pulses per totalizer unit via pulse scale.</p> <p>Digital Outputs 1 and 2</p> <p></p> <p>The two outputs can be operated as open collector passively or actively.</p> <p>Passive output</p>  <p>Active output (if analog output is not used)</p> 
<p>Solid-State Relay</p> <p></p>	<p>The solid-state relay is functionally linked with <i>Output 2</i>. See "Out 1 / 2 Function" below.</p> 

Digital Outputs	Pulse Width  S	This parameter establishes the ON duration of the transmitted pulse. The configurable range is from 0...2000 ms. If 0 ms is configured, pulse width is automatically adapted depending on pulse frequency (pulse/pause ratio 1:1). During the configuration the program checks if pulses/unit and pulse width are in accordance with full scale defined. If not, an error alarm displays and scale, pulse width or full scale need to be adapted.																								
	Pulse/Unit  S	The Pulses/Unit parameter lets you set how many pulses per unit of measure to transmit. The maximum output frequency of 10,000 pulses/sec. (10 KHZ) must not be exceeded.																								
	Out 1 /2 Function  S	The following functions can be selected for the <i>Output 1</i> , <i>Output 2</i> and the <i>Solid-State Relay</i> . The <i>Solid-State Relay</i> function is linked functionally with <i>Output 2</i> . <table border="1" data-bbox="625 625 1214 877"> <thead> <tr> <th>Function</th> <th>Out1</th> <th>Out2 / Solid-State Relay</th> </tr> </thead> <tbody> <tr> <td>Off</td> <td>X</td> <td>X</td> </tr> <tr> <td>Forward pulse</td> <td>X</td> <td>X</td> </tr> <tr> <td>Min/Max Alarm</td> <td>X</td> <td>X</td> </tr> <tr> <td>Error alarm</td> <td>X</td> <td>X</td> </tr> <tr> <td>Pump Control</td> <td>X</td> <td>X</td> </tr> <tr> <td>Test</td> <td>X</td> <td>X</td> </tr> <tr> <td>ADE</td> <td>X</td> <td></td> </tr> </tbody> </table> <ul style="list-style-type: none"> • OFF: Digital output is switched off. • Forward pulse: Generates pulses during forward flow conditions. • Min/Max Alarm: Indicates when flow rate exceeds thresholds defined by Set Min. or Set Max. in % of full scale. See “Figure 3: Tank volume or open-channel flow rate” on page 23. • Error alarm: Indicates when the meter has error an condition. • Pump Control: Starts or stops the pump. See “Figure 3: Tank volume or open-channel flow rate” on page 23. • Test: Used only for the <i>Verification Device</i>. • ADE: Used for BEACON and AquaCUE connectivity. 	Function	Out1	Out2 / Solid-State Relay	Off	X	X	Forward pulse	X	X	Min/Max Alarm	X	X	Error alarm	X	X	Pump Control	X	X	Test	X	X	ADE	X	
	Function	Out1	Out2 / Solid-State Relay																							
	Off	X	X																							
	Forward pulse	X	X																							
Min/Max Alarm	X	X																								
Error alarm	X	X																								
Pump Control	X	X																								
Test	X	X																								
ADE	X																									
Output 1 /2 Type  S	The output type parameter lets you set the output switch to “normally closed” or “normally open”.																									
Output 1 /2 Set Min  S	The flow Min Set Point establishes, as a percentage of full scale flow, the minimum threshold at which the output alarm activates. Select thresholds in 1% steps. Flow rates below or above the threshold activate the output alarm.																									
Output 1 /2 Set Max  S	The Flow Max Set Point establishes, as a percentage of full scale flow, the maximum threshold at which the output alarm activates. Select thresholds in 1% steps. Flow rates below or above the threshold activate the output alarm.																									
Flow Simulation  S	Flow Simulation provides analog and digital output simulation based on a percentage of the full scale flow in cases where no real flow is occurring. The range of simulation includes 0...100% in steps of 10% of the full scale flow. This function remains active when you exit the menu. You must set it to Off to deactivate it. If the simulation is still active, a character “S” displays in the <i>Measuring</i> mode.																									

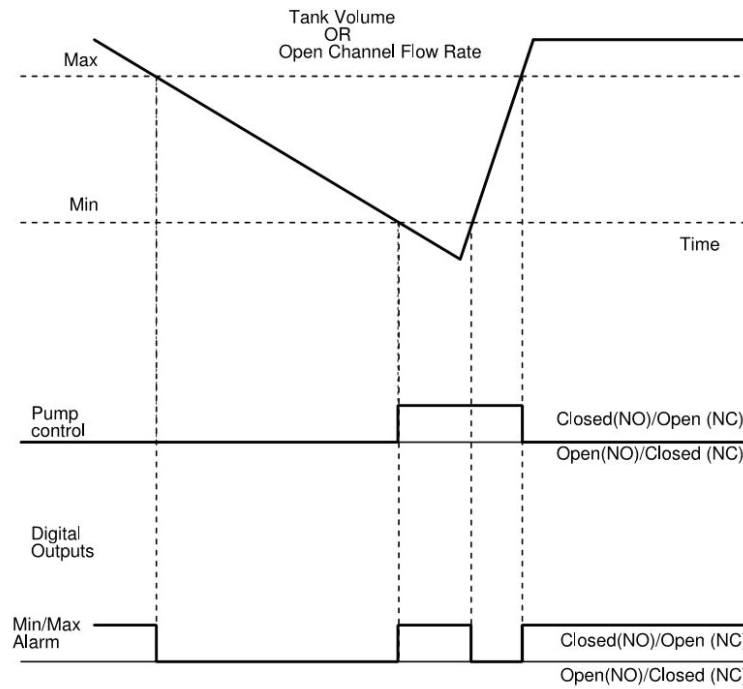

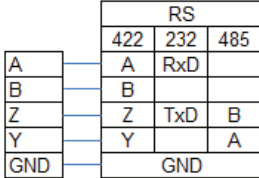
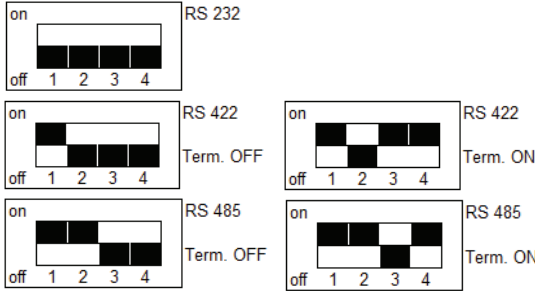

Figure 3: Tank volume or open-channel flow rate

Clear Total

<p>Total</p> 	<p>Resets the totalizer within the <i>ClearTot</i> item on the Flow Meter Tool software.</p>
---	--

Communications Menu

Interfaces	Modbus® RTU	<p>RS232, RS485 and RS422 with Modbus RTU.</p>  <p>Mode can be configured by DIP switches also if termination ON or OFF.</p> 
	<p>Modbus</p> <p>Address</p> <p>RS232, RS422, RS485</p>	<p>Address available from 1...247</p> <p>Baudrate: 1200, 2400, 4800, 9600, 19200, 38400 Bd</p> <p>Parity: Even, Odd, Mark, Received Packets, Sent Packets</p>
Ethernet	Modbus TCP/IP with MEAP-Header	
	IP Address	IPv4 address default 192.168.1.60
	IP Mask	IPv4 subnetting reference default 255.255.255.0
	IP Gateway	Gateway address default 192.168.1.1
	MAC Address	Media-Access-Control-Address
ADE	Control	ON or OFF
	Protocol	1 or 2
	Dial	4...9
	Resolution	0.001 / 0.01 / 0.1 / 1 / 10 / 100 / 1000 / 10,000

Miscellaneous

Power up	The number of times that the unit has been powered on.
Language	The unit supports these languages: English, German, Czech, Spanish, French, Russian
Date	Set the system date in the format [DD.MM.YY]; used for data logging.
Time	Set the system time in the format [HH.MM.SS]; used for data logging.
Contrast	The contrast of the display can be adjusted between 14 (low) and 49 (high).
Datalog Period	<p>The data logging period can be adjusted to every 10 min / 20 min / 30 min / 1 h / 24 h.</p> <p>There is a 2 MB memory with about 130,000 data records for data logging available. The logging capacities (uni-directional mode) and durations are:</p> <p>10 min up to 2.50 years</p> <p>20 min up to 5 years</p> <p>30 min up to 7.5 years</p> <p>1 h up to 15 years</p> <p>24 h up to 260 years</p> <p>The logging information can be downloaded by a PC program Flow Meter Tool.</p>

Info Menu

Serial Number	Serial number of the electronic board.
Version	Software version of the device.
Compilation Date	Date of the software version.
Otp CRC	Checksum of software update
Application CRC	Checksum of application

PIN Menu

The menus and parameters can be secured via three password levels. See "Setting a PIN" on page 13.

- Administrator PIN
- Service PIN
- User PIN

The password protection is a 6-digit PIN [000000] and is deactivated at the factory.

The first time you use the unit, activate the password protection *Control = On* and enter login with the password 000000.

Then go back to the PIN again and enter [User], [Service] and [Admin] password.

Once the password protection has been activated, enter your PIN under *Login* and the *lock open* symbol appears.

The PIN grants you access to Administrator, Service or User levels with the respective access rights. You can now move to the menu and enter parameters.

Without a login, you can read all parameters, but cannot change them.

Control	Activate and deactivate the PIN
User	User logged in with this PIN can access all User levels, but do not have access to Service or Admin functions.
Service	User logged in with this PIN will have access to both service and user-level procedures. User at this level will not have access to administrative functions.
Admin	User logged in with this PIN will have access to both service and user-level procedures.
Random Number	In case of losing PIN read the random number. This number has to be sent to Badger Meter support, which is able to generate the Emergency PIN. Between reading random number and entering received emergency PIN, do no try to play with emergency PIN and do not restart the meter.
Emergency PIN	In case of losing PIN read the random number. This number has to be sent to Badger Meter support, which is able to generate the emergency PIN. Between reading random number and entering received emergency PIN, do no try to play with emergency PIN and do not restart the meter.

Login Menu

Login	Once the password protection has been activated, enter your PIN.
--------------	--

TROUBLESHOOTING

The following error messages may display:

Description	Possible Cause	Recommended Action
Pulse Output	Pulse rate exceeds the maximum	Reduce pulse scale (pulse/unit) and/or reduce pulse width configuration
EEPROM	Configuration file is missing	Contact support
Configuration	Configuration file is corrupted	Contact support
Low Battery	Low backup battery (memory)	Contact support
Measure Timeout	Measurement was not completed within specific time	Contact support

Control LED

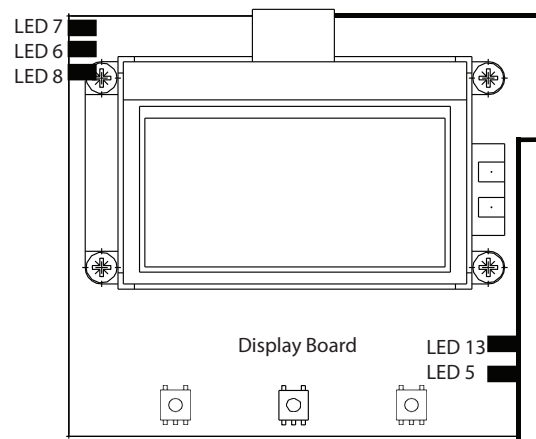
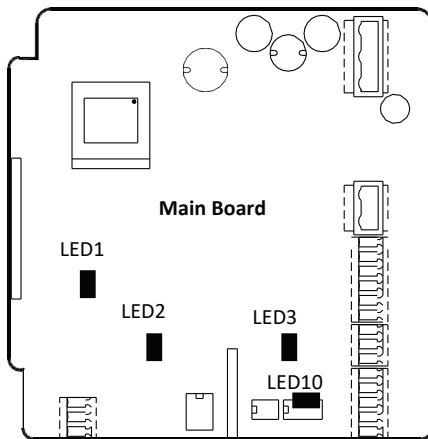

The following LEDs on the board control the operation of the device:

- LED1 No function attached
- LED3 Communication – transmit (On = active)
- LED5 Flash memory activity (DISK)
- LED6 Digital output #1 (On = active)
- LED7 Digital output #2 (On = active)
- LED8 No function attached
- LED10 Power ON (On = active)
- LED13 USB, HOST mode (On = active)

Replace Meter's Electronics

⚠ WARNING

DISCONNECT AUXILIARY POWER BEFORE OPENING THE BODY COVER.

1. Pull out all the plugs.
2. Loosen screws S1-S4 and take out circuit board.
3. Insert the new circuit board and attach it by fastening the screws S1-S4.
4. Plug in all plugs.
5. If necessary, configure the new board.

SPECIFICATIONS

Type	iSonic 4000					
Auxiliary power	92...275V AC (50/60 Hz), < 14 VA optional 9...36V DC, < 4 W					
Analog output	4...20 mA, 0...20 mA, 0...10 mA ≤ 800 Ohm, active or passive; Assigned parameter depends on flow meter mode					
Level sensor input	4...20 mA from level sensor					
Digital outputs	2 open collectors; passive: max. 32V DC, 0...100 Hz 100 mA, 100...10.000 Hz 20 mA; active: 24V DC, max 20 mA; Select active pulse, min/max alarm, error messages or pump control Solid-state relay (n.o./n.c.) max 230V AC, 500 mA, 1 Hz; Function is linked with open collector output 2					
Digital input	5...30V DC; totalizer reset, positive return zero, BEACON/AquaCUE connectivity					
Programming port	Mini USB, IP67					
Configuration	3 front-panel mounted push-buttons					
Communication	RS485 Modbus RTU, Modbus TCP/IP Ethernet, BEACON/AquaCUE connectivity					
Pulse length	Configurable up to 2000 msec					
Datalogger	2 MB capacity with 130,000 logged lines: date, level, flow rate, tank volume					
Display	Graphical LCD 64 × 128, backlight, actual flow rate, totalizers, status display					
Body	Die cast powder-coated aluminium, protection class IP67					
Cable inlet	Supply and signal cables 2 × M20; cable glands included					
Signal cable	From meter M20; cable gland included					
Ambient temperature	-20...60° C					
Sensors	Measuring range	Offset	Beam width	Material	Accuracy	Deadband
	4.92 in. (0...1250 mm)	2 in. (50 mm)	2 in. (50 mm)	PVDF	0.125 in. (3 mm)	2 in. (50 mm)
Security	Three level password					
Languages	English, Spanish, French, German, Italian, Czech, Russian					
Channel selection	Contracted rectangular weir, suppressed rectangular weir, Cipoletti weir; V-notch weir (30°, 45°, 60°, 90°); Parshall flume (1, 2, 3, 6, 9, 12, 18, 24, 36, 48 and 60 in.); Manhole flume (4, 6, 8, 10 and 12 in.); table entry, exponential equation, Manning rectangle flume, Manning pipe					

DIMENSIONS

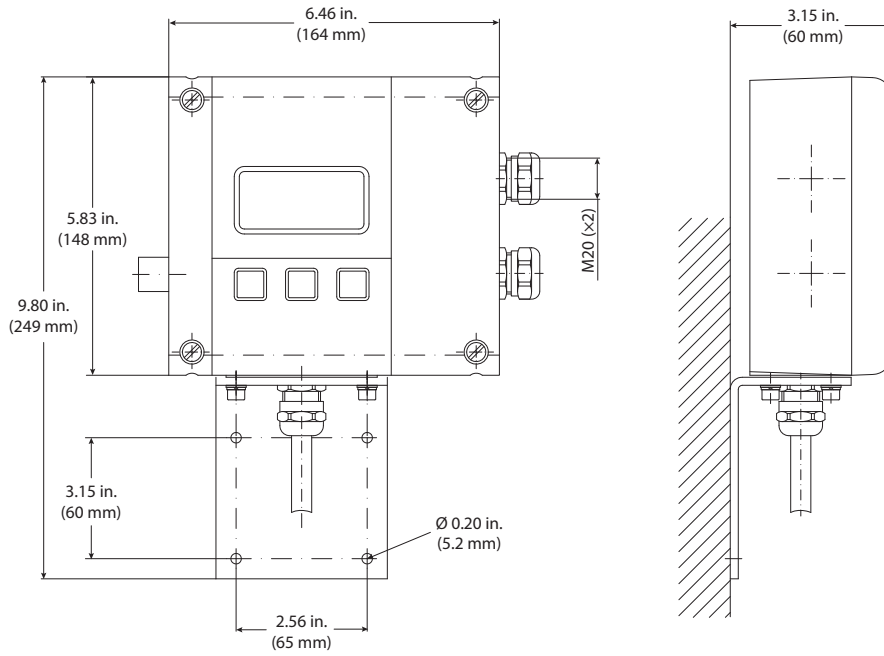

Figure 4: iSonic 4000 flow computer

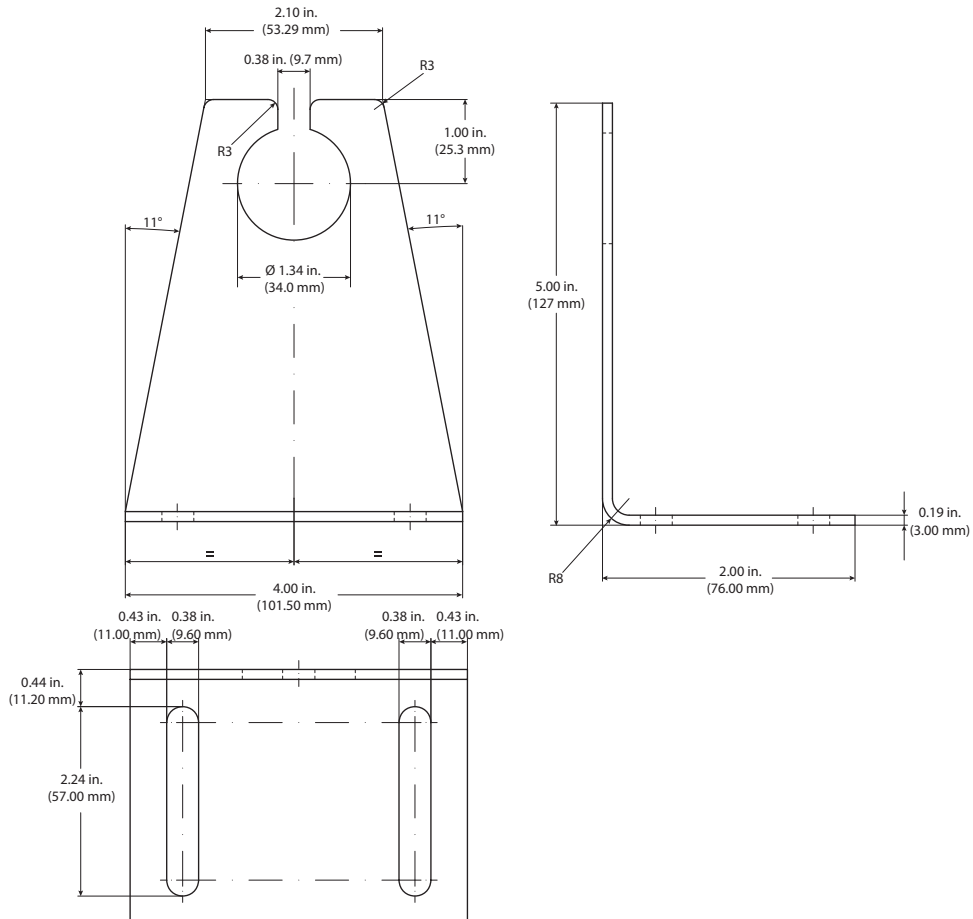

Figure 5: Sensor bracket

MAIN MENU PROGRAM STRUCTURE

Meter Setup

Application	Tank
	Open Channel
Sensor	Interval
	Warm Up Time
	Lower Range Value
	Upper Range Value
	Offset

Measurements

Length	Unit	ft
		m
		in
		cm
		mm
		Decimal Places
Flow Rate	Unit	L/s
		L/min
		L/h
		m ³ /s
		m ³ /min
		m ³ /h
		ft ³ /s
		ft ³ /min
		ft ³ /h
		gal/s
		gal/min
		gal/h
		MG/D
		IG/s
		IG/min
		IG/h
bbl/min		
Decimal Places		
Volume	Unit	L
		hL
		m ³
		ft ³
		gal
		MG
		IG
		bbl
		Aft
		Decimal Places

Measurements (continued)

Equation Selection	Table	
	Exponential Eq	
	Contract. Weir	
	Suppress. Weir	
	Cipoletti Weir	
	V NotchWeir30°	
	V NotchWeir45°	
	V NotchWeir60°	
	V NotchWeir90°	
	Manning Rect.	
	Manning Pipe	
	Pars. Flume 1"	
	Pars. Flume 2"	
	Pars. Flume 3"	
	Pars. Flume 6"	
	Pars. Flume 9"	
	Par. Flume 12"	
	Par. Flume 18"	
	Par. Flume 24"	
	Par. Flume 36"	
Par. Flume 48"		
Par. Flume 60"		
Manh. Flume 4"		
Manh. Flume 6"		
Manh. Flume 8"		
Manh. Flume 10"		
Manh. Flume 12"		
Equation Params	Exponent	
	Coefficient	
	Width	
	Angle	
	Radius	
	Water Surface Slope	
	Surface Roughness	
	Max. Water Level	SetDefaultVal.
		Exit
	Max. Water Level	
Upper Range Value	Calculate	
	Exit	

Inputs/Outputs

Analog Output	Select Range	4...20 mA 0...20 mA 0...10 mA	
	Alarm Mode	Off 23 mA 3.5 mA	
	Compensation		
	Digital Input	Off Remote Reset Pos Zero Reset ADE	
Digital Output	Pulse Width		
	Pulse/Unit		
	Out 1 function	Off	
		Forward Pulses	
		Min/Max Alarm	
		Error Alarm	
		Test	
		Pump Control	
	Out 1 Type	Normally Open	
		Normally Close	
	Out 1 Set Min		
	Out 1 Set Max		
	Out 2 Function	Off	
		Forward Pulses	
Min/Max Alarm			
Error Alarm			
Test			
Pump Control			
Out 2 Type	Normally Open		
	Normally Close		
Out 2 Set Min			
Out 1 Set Min			
Simulation	Off		
	+100.0%		
	+90%		
	+80%		
	+70%		
	+60%		
	+50%		
	+40%		
	+30%		
	+20%		
	+10%		
	0.0%		

Total

Total	Clear Tot
	Exit

Communications

Modbus	MODBUS Address		
	RS-232/422/485	Baud Rate	1200
			2400
			4800
			9600
			19200
		38400	
		115200	
	Parity	Even	
		Odd	
Ethernet	Received Packets		
	Sent Packets		
	IP Address		
	IP Gateway		
	MAC Address		
ADE	Control	On	
		Off	
	Protocol	1	
		2	
	Dial	4...9	
Resolution	0.0001...10000		

Miscellaneous

Power up			
Language	English	Español	Italiano
	Deutsch	Français	Türkçe
	Český	Русский	Polski
Date [DDMMYY]			
Time [HHMMSS]			
EEPROM	Format		
	Exit		
Contrast			
Datalog Period	10 min		
	20 min		
	30 min		
	1 h		
	24 h		

Info

Serial Number
Version
Compilat. Date
Otp CRC
Applicat. CRC

Pin

Control
User
Service
Admin
Random Number
Emergency PIN

Login

Login

FLOW METER MODBUS® REGISTER TABLE

Address	Registers	Rights	Name	iSonic
0x0000	U16	Read only	PRODUCT_CODE	7: iSonic
0x0001	8	Read only	PRODUCT_NAME	"iSonic 4000"
0x0009	16	Read only	FW_NAME	"iSonic_A_STM32F107RC"
0x0019	10	Read only	APP_VERSION	Version
0x0023	16	Read only	COMPILATION_DATE	Date of compilation
0x0033	16	Read only	COMPILATION_TIME	Time of compilation
0x0043	5	Factory	IDENTIFICATION_NUMBER	Unique number
0x0048	3	Read only	OTP_BOOT_CHECKSUM	Checksum
0x004B	3	Read only	FLASH_OS_CHECKSUM	Checksum
0x0081	U16	User	POWER_LINE_FREQUENCY	0: 50 Hz 1: 60 Hz
0x0095	U16	Service	ANALOG_OUTPUT_RANGE	1: 4...20 mA 2: 0...20 mA 3: 0...10 mA
0x00A1	U16	Service	OUT1_LOW	Digital Output setting
0x00A2	U16	Service	OUT1_HIGH	Digital Output setting
0x00A3	U16	Service	OUT1_MODE	0 normally open 1 normally closed
0x00A4	U16	Service	OUT1_OPERATION	0: Off 1: Comparator 3: Error alarm 4: Forward 10: Test 14: Pump
0x00AE	U16	Service	OUT2_LOW	Digital Output setting
0x00AF	U16	Service	OUT2_HIGH	Digital Output setting
0x00B0	U16	Service	OUT2_MODE	0 normally open 1 normally closed
0x00B1	U16	Service	OUT2_OPERATION	0 Off 1 Min/Max Alarm 3 Error alarm 4 Forward pulses 10 Test 14 Pump control
0x0114	U16	User	LANGUAGE	0 English 1 German 2 Czech 3 Spanish 4 French 5 Russian 6 Italian 7 Turkish
0x0115	Float	Read only	MEASURE	Dry calibration
0x0119	U16	Read only	MEASURE_COUNTER	Dry calibration

Address	Registers	Rights	Name	iSonic
0x0125	U16	Admin	COMMAND	1: save configuration 2: restore configuration 6: save totalizers 7: clear totalizers 8: clear totalizers 14: current loop calibration point A 15: current loop calibration point B 16: current loop calibration complete 22: default save 23: remote reset 24: default restore 26: make file system 34: press key up 35: press key right 36: press key save exit 38: print screen 41: open channel – calculate upper range 42: open channel – use default water level
0x0126	Float	Factory	CURRENTLOOP_POINTA	Dry calibration
0x0128	Float	Factory	CURRENTLOOP_POINTB	Dry calibration
0x012A	U16	Service	SIMULATION	Not stored in non-volatile memory 0: 0.0% 10: + 10.0% 20: + 20.0% 30: + 30.0% 40: + 40.0% 50: + 50.0% 60: + 60.0% 70: + 70.0% 80: + 80.0% 90: + 90.0% 100: +100.0% 65408: Off 65436: -100.0% 65446: - 90.0% 65456: - 80.0% 65466: - 70.0% 65476: - 60.0% 65486: - 50.0% 65496: - 40.0% 65506: - 30.0% 65516: - 20.0% 65526: - 10.0%
0x012B	U32	Read only	RANDOM	Security
0x012E	U16	Service	ALARM_MODE_OF_ANALOG_OUTPUT	0: none 3: 23 mA 4: 3.5 mA
0x012F	U32	Write only	REMOTE_LOGIN	Security
0x0202	Float	Service	PULSE_PULSES_PER_M3	Digital Output setting
0x0204	U16	Service	PULSE_WIDTH	Digital Output setting
0x0205	U16	Service	OUT_LOW	OBSOLETE

Address	Registers	Rights	Name	iSonic
0x0206	U16	Service	OUT_HIGH	OBSOLETE
0x0226	6	Service	DATETIME	Date & Time
0x0232	U16	Read only	FAULT	Bit0: Low Battery Bit1: Measure Timeout Bit2: Table Error Bit6: Flow Overload Warning Bit7: Disk Error Bit8: Configuration Error Bit9: Pulse Overload Warning Bit10: Sensor Disconnected Error Bit11: Sensor Shorted Error
0x0233	8	Read only	PORT	Debug information
0x023D	U16	Admin	PASSWORD_CONTROL	Security
0x023E	4	User	PASSWORD_SET_USER	Security
0x0242	4	Service	PASSWORD_SET_SERVICE	Security
0x0246	4	Admin	PASSWORD_SET_ADMIN	Security
0x025B	U64	Read only	FS_TOT	Internal Disk Size [byte]
0x025F	U64	Read only	FS_FRE	Internal Disk Free Space [byte]
0x0263	U16	Service	DATALOGGER_PERIOD	10: 10 min 20: 20 min 30: 30 min 61: 1 hour 84: 24 hour
0x0267	U16	Service	MEDIAN	Filter setting
0x0268	U16	Service	MOVING_AVERAGE	Filter setting
0x0279	Float	Read only	ANALOG_OUTPUT_K	Dry calibration
0x0281	Float	Read only	ANALOG_OUTPUT_Q	Dry calibration
0x02B3	Float	Service	ANALOG_OUTPUT_COMPENSATION	Analog Output Compensation
0x02E3	U32	Read only	POWER_UP_COUNTER	Power up counter
0x0300	U16	Admin	DATAPROCESSING_TANK_OPENCHANNEL	0 Tank 1 Open Channel
0x0301	U16	User	UNITCODES_LENGTH	44 Feet 45 Meters 47 Inches 48 Centimeters 49 Millimeters
0x0302	U16	User	UNITCODES_VOLUMETRICFLOW	15 Cubic Feet Per Minute 16 Gallons Per Minute 17 Liters Per Minute 18 Imperial Gallons Per Minute 19 Cubic Meter Per Hour 22 Gallons Per Second 23 Million Gallons Per Day 24 Liters Per Second 26 Cubic Feet Per Second 28 Cubic Meters Per Second 30 Imperial Gallons Per Hour 130 Cubic Feet Per Hour 131 Cubic Meters Per Minute 133 Barrels Per Minute 136 Gallons Per Hour 137 Imperial Gallons Per Second 138 Liters Per Hour

Address	Registers	Rights	Name	iSonic
0x0303	U16	User	UNITCODES_VOLUME	40 Gallons 41 Liters 42 Imperial Gallons 43 Cubic Meters 46 Barrels 112 Cubic Feet 236 Hectoliters 240 Mega Gallons 241 Acre Feet
0x0304	U16	User	DECIMALPLACES_LENGTH	Number of decimal places of length
0x0305	U16	User	DECIMALPLACES_VOLUMETRICFLOW	Number of decimal places of volumetric flow
0x0306	U16	User	DECIMALPLACES_VOLUME	Number of decimal places of volume
0x0307	U16	Admin	OPENCHANNEL_EQUATION	0: Open Channel Table 3: Contracted Rectangular Weir 4: Suppressed Rectangular Weir 5: Cipoletti Weir 7: Manning Equation Rectangular Channel 8: Manning Equation Pipe 9: V Notch Weir 30° 10: V Notch Weir 45° 11: V Notch Weir 60° 12: V Notch Weir 90° 13: Parshall Flume 1" 14: Parshall Flume 2" 15: Parshall Flume 3" 16: Parshall Flume 6" 17: Parshall Flume 9" 18: Parshall Flume 12" 19: Parshall Flume 18" 20: Parshall Flume 24" 21: Parshall Flume 36" 22: Parshall Flume 48" 23: Parshall Flume 60" 24: Manhole Flume 4" 25: Manhole Flume 6" 26: Manhole Flume 8" 27: Manhole Flume 10" 28: Manhole Flume 12" 29: Exponential Equation
0x0308	Float	Admin	SENSOR_UPPERRANGEVALUE	Sensor description [m]
0x030A	Float	Admin	SENSOR_LOWERRANGEVALUE	Sensor description [m]
0x030C	Float	Factory	SENSOR_DIVISIONTOCURRENT_K	Dry calibration
0x030E	Float	Factory	SENSOR_DIVISIONTOCURRENT_Q	Dry calibration
0x0310	Float	Read only	SENSOR_WATERLEVEL	Actual water level
0x0312	Float	Read only	DATAPROCESSING_OPENCHANNELFLOW	Actual volumetric flow
0x0314	Float	Read only	DATAPROCESSING_TANKVOLUME	Actual tank volume
0x0316	Float	Read only	TOTALIZER	Totalizer
0x0318	Float	Read only	SENSOR_CURRENT	Sensor actual current
0x031A	Float	Service	OPENCHANNEL_UPPERRANGEVALUE	Open channel description
0x031C	Float	Service	TANK_UPPERRANGEVALUE	Tank description
0x031E	U16	Service	MEASURE_WARMUPTIME	Sensor setting
0x031F	U16	Service	MEASURE_INTERVAL	Sensor setting

Address	Registers	Rights	Name	iSonic
0x0320	16	User	DESIGNATION_CURRENT	UTF-8 Designation of sensor current
0x0330	16	User	DESIGNATION_WATERLEVEL	UTF-8 Designation of water level
0x0340	16	User	DESIGNATION_FLOW	UTF-8 Designation of flow
0x0350	16	User	DESIGNATION_VOLUME	UTF-8 Designation of volume
0x0360	32	User	DESIGNATION_TAG	UTF-8 Designation of device
0x0380	Float	Service	SENSOR_WATERLEVELOFFSET	Offset
0x0388	Float	Admin	SENSOR_UPPERRANGEVALUE_ACTUALUNIT	Sensor description
0x038A	Float	Admin	SENSOR_LOWERRANGEVALUE_ACTUALUNIT	Sensor description
0x0390	Float	Read only	SENSOR_WATERLEVEL_ACTUALUNIT	Actual water level
0x0392	Float	Read only	DATAPROCESSING_OPENCHANNELFLOW_ACTUALUNIT	Actual volumetric flow
0x0394	Float	Read only	DATAPROCESSING_TANKVOLUME_ACTUALUNIT	Actual tank volume
0x0396	Float	Read only	TOTALIZER_ACTUALUNIT	Totalizer
0x0398	Float	Service	SENSOR_WATERLEVELOFFSET_ACTUALUNIT	Offset
0x039A	Float	Service	OPENCHANNEL_UPPERRANGEVALUE_ACTUALUNIT	Open channel description
0x039C	Float	Service	TANK_UPPERRANGEVALUE_ACTUALUNIT	Tank description
0x0400	Float	Admin	OPENCHANNEL_EXPONENT	Open channel calibration
0x0402	Float	Admin	OPENCHANNEL_COEFFICIENT	Open channel calibration
0x0404	Float	Admin	OPENCHANNEL_WIDTH	Open channel calibration
0x0406	Float	Admin	OPENCHANNEL_ANGLE	Open channel calibration
0x040C	Float	Admin	OPENCHANNEL_RADIUS	Open channel calibration
0x040E	Float	Admin	OPENCHANNEL_WATERSURFACESLOPE	Open channel calibration
0x0410	Float	Admin	OPENCHANNEL_SURFACEROUGHNESS	Open channel calibration
0x0412	Float	Admin	OPENCHANNEL_WATERLEVELMAXIMUM	Open channel calibration
0x0414	Float	Admin	OPENCHANNEL_COEFFICIENT_ACTUALUNIT	Open channel calibration
0x0416	Float	Admin	OPENCHANNEL_WIDTH_ACTUALUNIT	Open channel calibration
0x0418	Float	Admin	OPENCHANNEL_RADIUS_ACTUALUNIT	Open channel calibration
0x041A	Float	Admin	OPENCHANNEL_WATERLEVELMAXIMUM_ACTUALUNIT	Open channel calibration
0x041C	Float	Admin	OPENCHANNEL_SURFACEROUGHNESS_ACTUALUNIT	Open channel calibration

iSonic 4000 Flow Meter Conversion Table

Address	Registers	Rights	Read	Write	Name	Note
0x0500	Float, Float	Admin	Yes	Yes	Conversion Table Point 0	Water Level [m], Volume [m ³] or Flow[m ³ /s]
...					...	
0x08FC	Float, Float	Admin	Yes	Yes	Conversion Table Point 255	—

Points in conversion table have to be sorted in ascending order (higher address higher water level value).

Table can be shorter. First unused point has to contain NAN value.

Rights

- 1 User
- 2 Service
- 3 Admin
- 4 Factory

WIRING THE ISONIC 4000 METER TO AN ORION® CELLULAR LTE ENDPOINT

1. Connect the RED Encoder Clock signal wire from the endpoint to the Digital Input on the iSonic 4000.
2. Connect the GREEN Encoder Data signal wire from the endpoint to the Digital Output 1 positive signal on the iSonic 4000.
3. Connect the BLACK Encoder Ground signal wire from the endpoint to the Digital Output 1 negative signal on the iSonic 4000.
4. Jumper the iSonic 4000 Digital Output 1 negative signal to the Digital Input negative signal.

For detail information on installing and activating ORION Cellular LTE endpoints, see the "ORION Water Endpoints User Manual", available on our website at www.badgermeter.com.

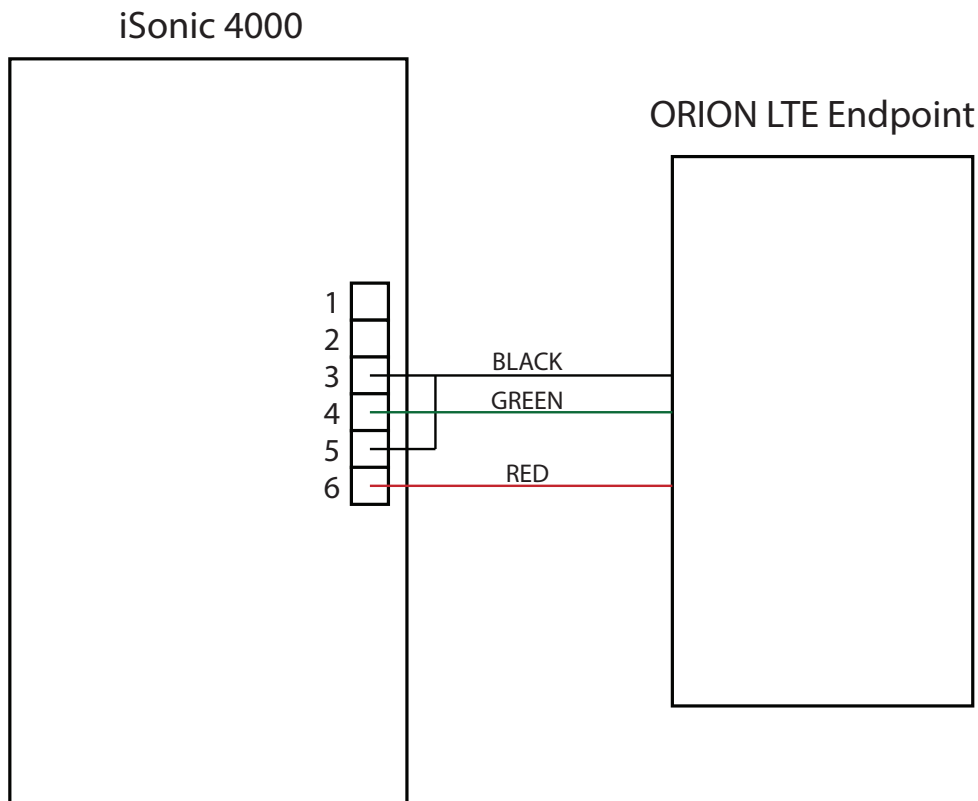

Control. Manage. Optimize.

Trademarks appearing in this document are the property of their respective entities. Due to continuous research, product improvements and enhancements, Badger Meter reserves the right to change product or system specifications without notice, except to the extent an outstanding contractual obligation exists. © 2018 Badger Meter, Inc. All rights reserved.

www.badgermeter.com